



VERY LOW DROP VOLTAGE REGULATORS WITH INHIBIT

- VERY LOW DROPOUT VOLTAGE (0.2V TYP. AT 50mA LOAD)
- VERY LOW QUIESCENT CURRENT (TYP. 500 μ A AT 50mA LOAD)
- OUTPUT CURRENT UP TO 50mA
- LOGIC-CONTROLLED ELECTRONIC SHUTDOWN
- OUTPUT VOLTAGES OF 2.85; 3.0; 3.2; 3.3; 3.8; 5.0V
- INTERNAL CURRENT AND THERMAL LIMIT
- SUPPLY VOLTAGE REJECTION: 63dB (TYP)
- ONLY 1 μ F FOR STABILITY
- SELECTION AT 25°C
- TEMPERATURE RANGE: -25°C TO 125°C
- PACKAGE AVAILABLE: SOT23-5L AND TO-92

DESCRIPTION

The LD2979 series are very Low Drop regulators available in SOT23-5L and TO-92.

The very low drop-voltage and the very low quiescent current make them particularly suitable for low noise, low power applications and in battery powered systems.

Shutdown Logic Control function is available on five pin version (TTL compatible). This means that

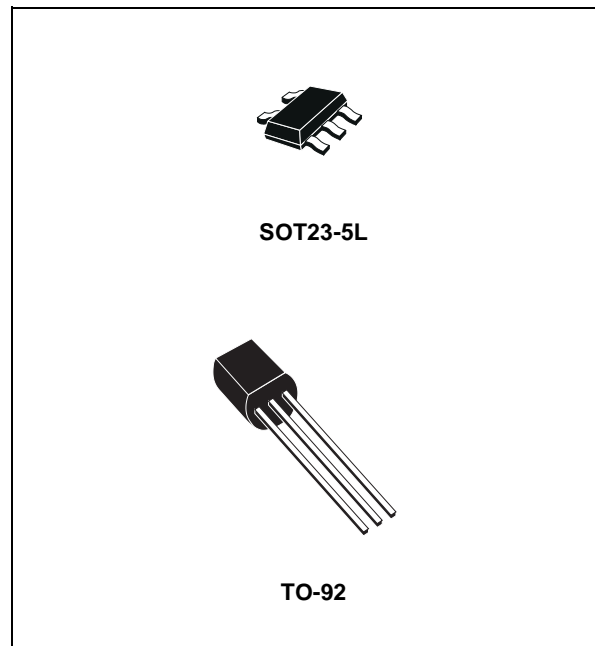

when the device is used as local regulator, it is possible to put a part of the board in standby, decreasing the total power consumption.

SCHEMATIC DIAGRAM

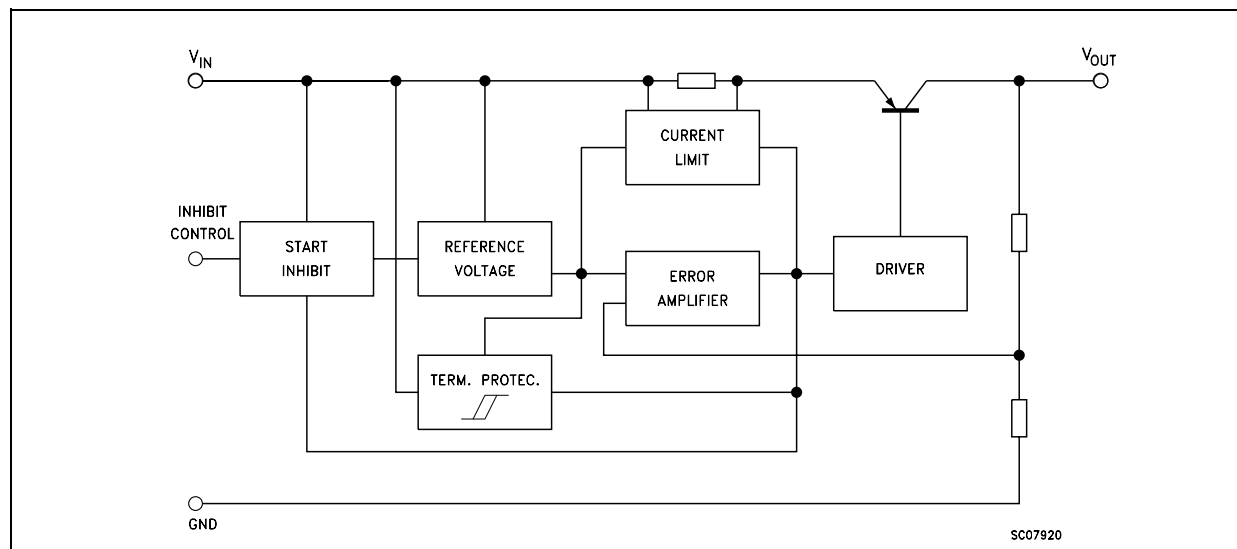

LD2979 SERIES

ABSOLUTE MAXIMUM RATINGS

Symbol	Parameter	Value	Unit
V_I	DC Input Voltage	16	V
V_{INH}	DC Inhibit Input Voltage	V_{IN}	V
I_O	Output Current	Internally limited	
P_{tot}	Power Dissipation	Internally limited	
T_{stg}	Storage Temperature Range	-40 to 150	°C
T_{op}	Operating Junction Temperature Range	-25 to 125	°C

Absolute Maximum Ratings are those values beyond which damage to the device may occur. Functional operation under these condition is not implied.

CONNECTION DIAGRAM (top view)

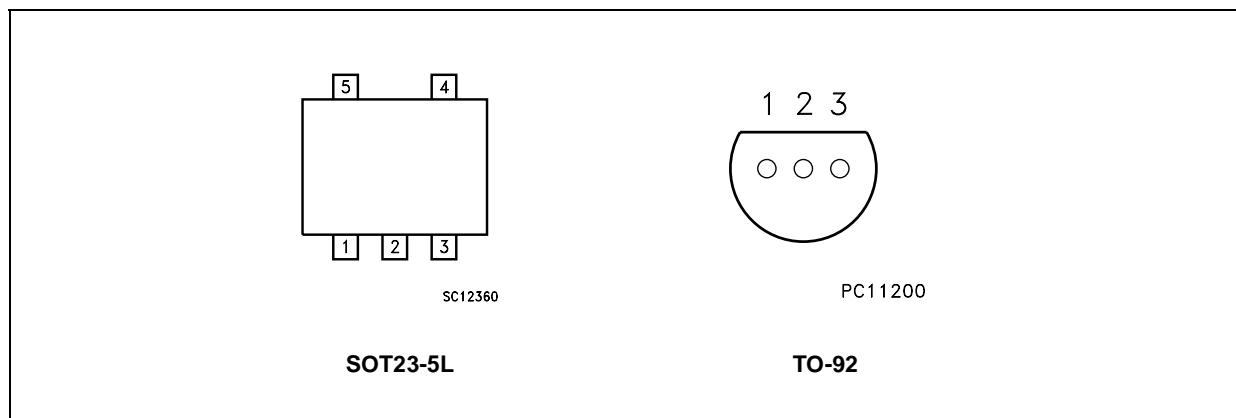

PIN DESCRIPTION

SYMBOL	NAME AND FUNCTION	PIN NUMBER	
		SOT23-5L	TO-92
V_{IN}	Input Voltage	1	3
GND	Ground	2	2
INHIBIT	Control Switch ON/OFF (*)	3	
NC	Not to be connected	4	
V_{OUT}	Output Voltage	5	1

(*) Only for the version in SOT23-5L package: Inhibit pin is not internally pulled-up then it must not be left floating. Connect to a positive voltage higher than 2V to able the device.

ORDERING CODES

SOT23-5L (T&R)	TO-92	TO-92 (T&R)	TO-92 (Ammo Pack)	OUTPUT VOLTAGES
LD2979M28TR	LD2979Z28	LD2979Z28TR	LD2979Z28AP	2.85 V
LD2979M30TR	LD2979Z30	LD2979Z30TR	LD2979Z30AP	3.0 V
LD2979M32TR	LD2979Z32	LD2979Z32TR	LD2979Z32AP	3.2 V
LD2979M33TR	LD2979Z33	LD2979Z33TR	LD2979Z33AP	3.3 V
LD2979M38TR	LD2979Z38	LD2979Z38TR	LD2979Z38AP	3.8 V
LD2979M50TR	LD2979Z50	LD2979Z50TR	LD2979Z50AP	5.0 V

ELECTRICAL CHARACTERISTICS FOR LD2979 (refer to the test circuits, $T_a = 25^\circ\text{C}$, $V_{IN} = V_{O(NOM)} + 1\text{V}$, $I_O = 1\text{mA}$, $V_{INH} = 2\text{V}^{(*)}$, $C_O = 1\mu\text{F}$) (unless otherwise specified)

Symbol	Parameter	Test Conditions	Min.	Typ.	Max.	Unit
V_O	Output Voltage	$V_{IN} = 3.85\text{ V}$	2.793	2.85	2.907	V
		$I_O = 1\text{ to }50\text{mA}$ $T_a = -25\text{ to }125^\circ\text{C}$	2.736		2.964	
V_O	Output Voltage	$V_{IN} = 4\text{ V}$	2.940	3	3.060	V
		$I_O = 1\text{ to }50\text{mA}$ $T_a = -25\text{ to }125^\circ\text{C}$	2.880		3.120	
V_O	Output Voltage	$V_{IN} = 4.2\text{ V}$	3.136	3.2	3.264	V
		$I_O = 1\text{ to }50\text{mA}$ $T_a = -25\text{ to }125^\circ\text{C}$	3.072		3.328	
V_O	Output Voltage	$V_{IN} = 4.3\text{ V}$	3.234	3.3	3.366	V
		$I_O = 1\text{ to }50\text{mA}$ $T_a = -25\text{ to }125^\circ\text{C}$	3.168		3.432	
V_O	Output Voltage	$V_{IN} = 4.8\text{ V}$	3.724	3.8	3.876	V
		$I_O = 1\text{ to }50\text{mA}$ $T_a = -25\text{ to }125^\circ\text{C}$	3.648		3.952	
V_O	Output Voltage	$V_{IN} = 6\text{ V}$	4.9	5	5.1	V
		$I_O = 1\text{ to }50\text{mA}$ $T_a = -25\text{ to }125^\circ\text{C}$	4.8		5.2	
I_{out}	Output Current Limit		100			mA
ΔV_O	Line Regulation	$V_{IN} = V_{O(NOM)} + 1\text{V to }16\text{V}$, $I_O = 1\text{mA}$			0.028	%/ V_{IN}
		$T_a = -25\text{ to }125^\circ\text{C}$			0.064	
I_d	Quiescent Current (On Mode)	$I_O = 0$		80	110	μA
		$I_O = 0$ $T_a = -25\text{ to }125^\circ\text{C}$			170	
		$I_O = 50\text{mA}$		500	700	
		$I_O = 50\text{mA}$ $T_a = -25\text{ to }125^\circ\text{C}$			1300	
I_d	Quiescent Current (Off Mode) (*)	$V_{INH} < 0.18\text{ V}$		0		μA
		$V_{INH} < 0.18\text{ V}$ $T_a = -25\text{ to }125^\circ\text{C}$			1	
SVR	Supply Voltage Rejection	$I_O = 50\text{mA}$ $C_{OUT} = 10\mu\text{F}$ $f = 120\text{Hz}$		63		dB
V_d	Dropout Voltage	$I_O = 0$		6	12	mV
		$I_O = 0$ $T_a = -25\text{ to }125^\circ\text{C}$			18	
		$I_O = 1\text{mA}$		30	60	
		$I_O = 1\text{mA}$ $T_a = -25\text{ to }125^\circ\text{C}$			90	
		$I_O = 10\text{mA}$		100	200	
		$I_O = 10\text{mA}$ $T_a = -25\text{ to }125^\circ\text{C}$			300	
		$I_O = 50\text{mA}$		200	400	
		$I_O = 50\text{mA}$ $T_a = -25\text{ to }125^\circ\text{C}$			600	
V_{IL}	Inhibit Input Logic Low	Device Off $T_a = -25\text{ to }125^\circ\text{C}$ (*)			0.18	V
V_{IH}	Inhibit Input Logic High	Device On $T_a = -25\text{ to }125^\circ\text{C}$ (*)	2			V
I_I	Inhibit Input Current	$V_{INH} = 0\text{ V}$ (*)		0	-1	μA
		$V_{INH} = 5\text{ V}$ $T_a = -25\text{ to }125^\circ\text{C}$		5	15	
eN	Output Noise Voltage (RMS)	$\text{BW} = 300\text{Hz to }50\text{KHz}$ $C_O = 10\mu\text{F}$		160		μV

(*) Note: Only for types in SOT23-5L

TYPICAL CHARACTERISTICS (unless otherwise specified $T_a = 25^\circ\text{C}$)

Figure 1 : Output Voltage vs Temperature

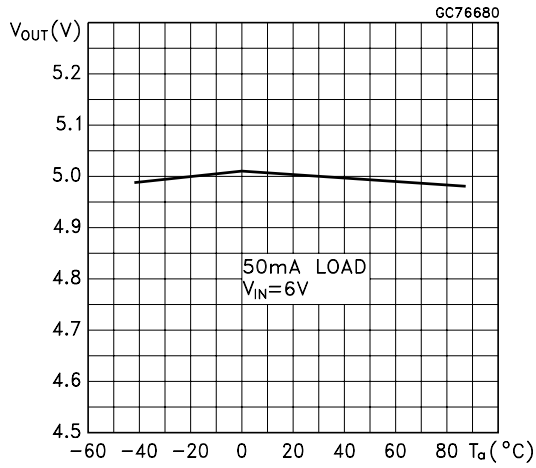

Figure 2 : Output Voltage vs Input Voltage

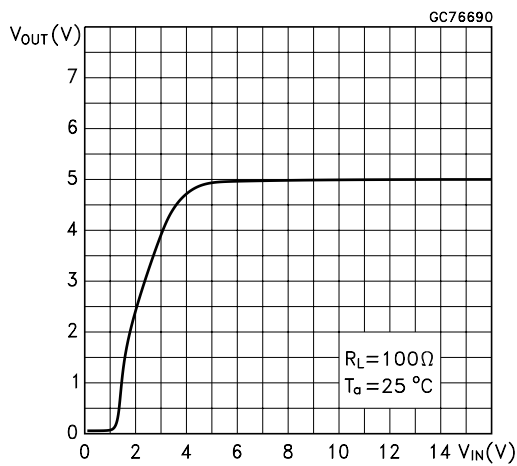

Figure 3 : Output Voltage vs Input Voltage

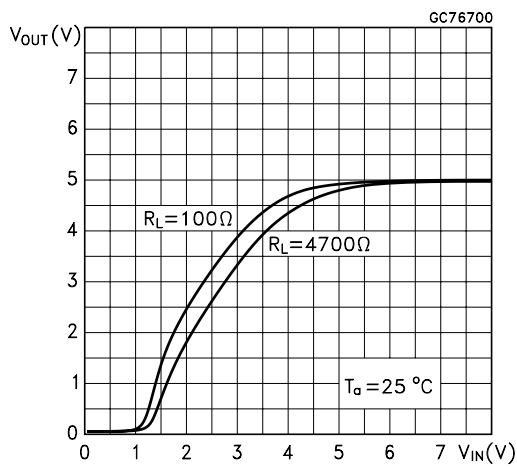

Figure 4 : Dropout Voltage vs Output Current

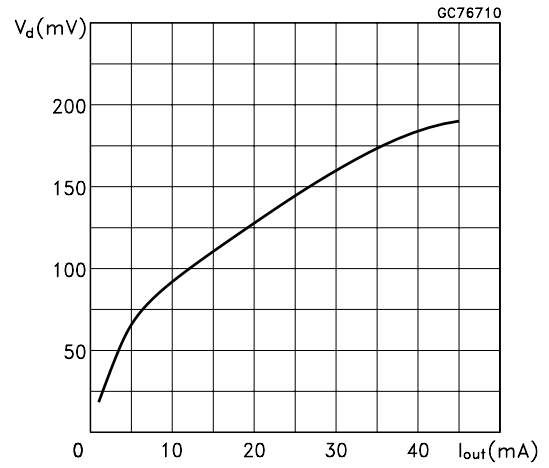

Figure 5 : Dropout Voltage vs Temperature

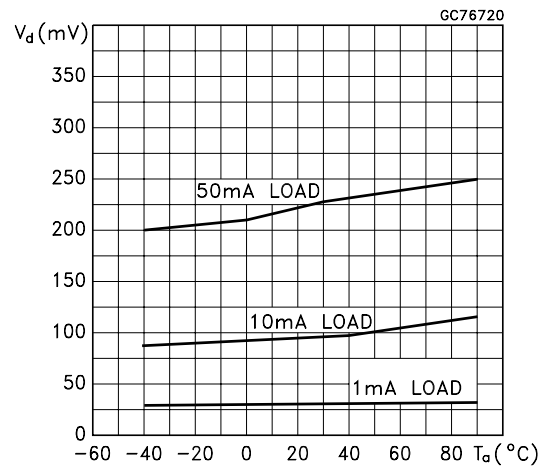

Figure 6 : Quiescent Current vs Temperature

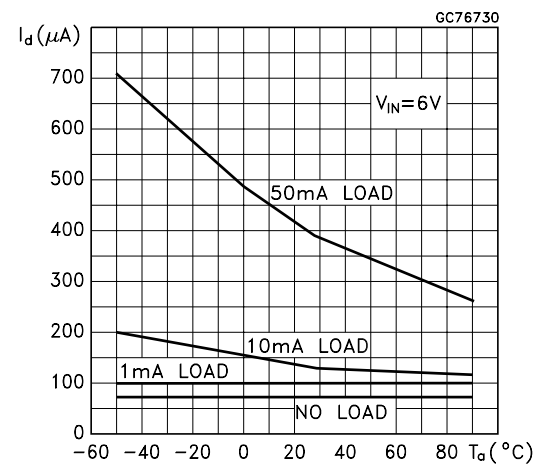

Figure 7 : Short Circuit Current vs Dropout Voltage

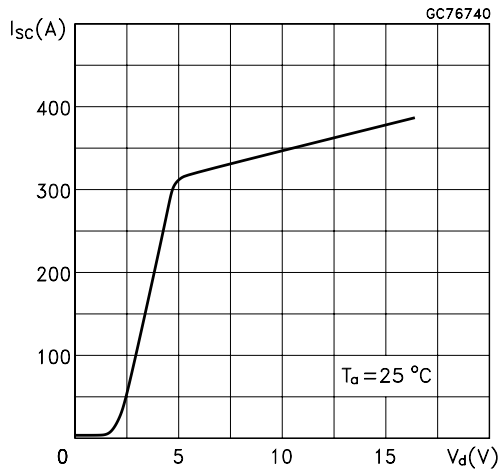

Figure 10 : Inhibit Voltage vs Temperature

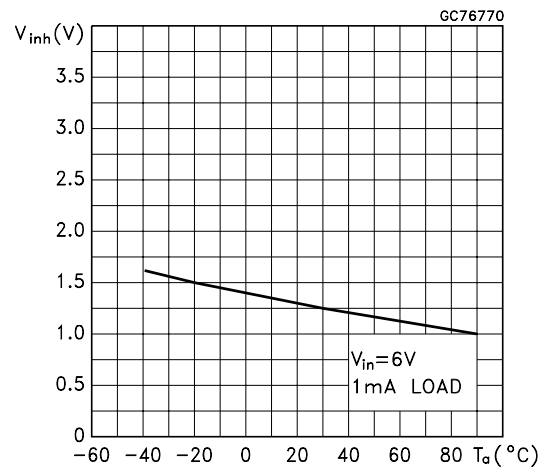

Figure 8 : Supply Voltage Rejection vs Frequency

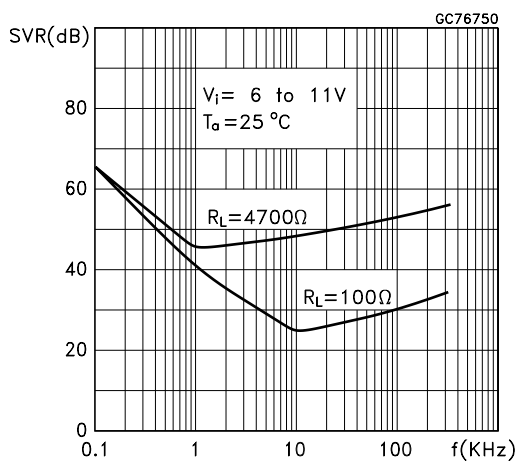

Figure 11 : Load Transient Response

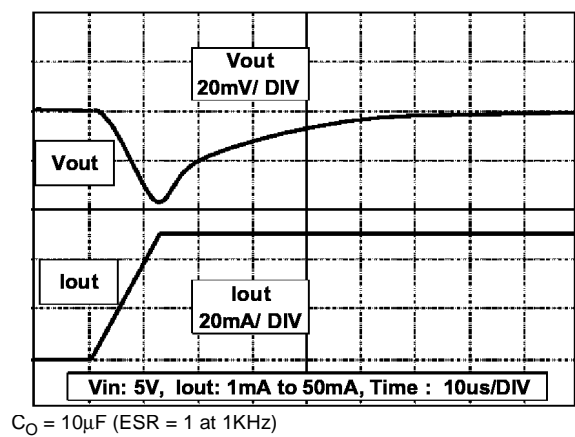

Figure 9 : Inhibit Current vs Temperature

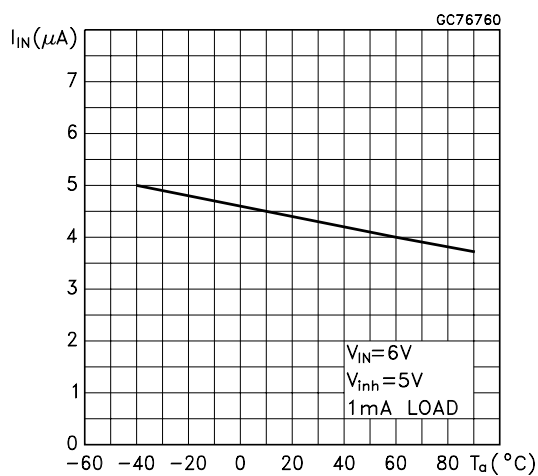

Figure 12 : Load Transient Response

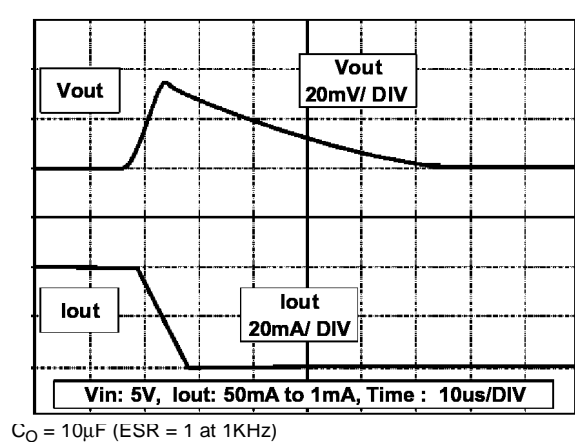
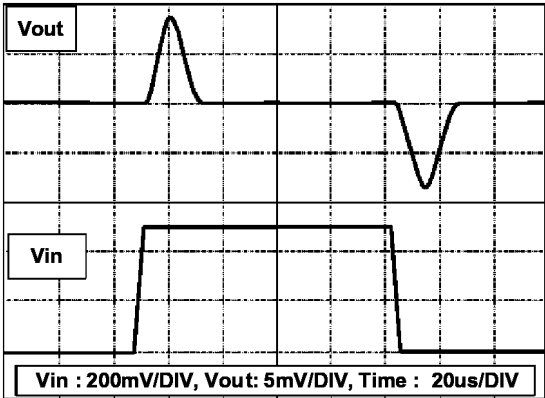

Figure 13 : Line Transient Response



$C_O = 10\mu\text{F}$ (ESR = 1 at 1KHz)

SOT23-5L MECHANICAL DATA

DIM.	mm.			mils		
	MIN.	TYP.	MAX.	MIN.	TYP.	MAX.
A	0.90		1.45	35.4		57.1
A1	0.00		0.15	0.0		5.9
A2	0.90		1.30	35.4		51.2
b	0.35		0.50	13.7		19.7
C	0.09		0.20	3.5		7.8
D	2.80		3.00	110.2		118.1
E	2.60		3.00	102.3		118.1
E1	1.50		1.75	59.0		68.8
e		0.95			37.4	
e1		1.9			74.8	
L	0.35		0.55	13.7		21.6

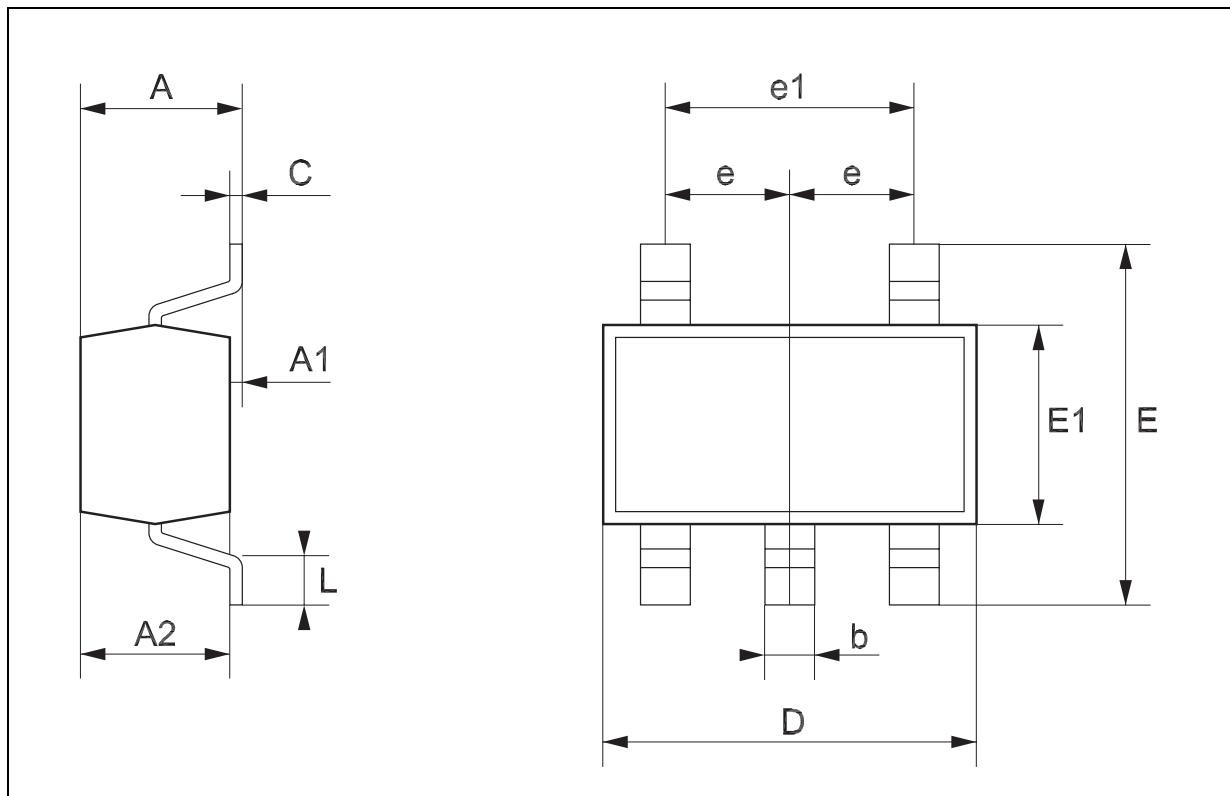

Tape & Reel SOT23-xL MECHANICAL DATA

DIM.	mm.			inch		
	MIN.	TYP	MAX.	MIN.	TYP.	MAX.
A			180			7.086
C	12.8	13.0	13.2	0.504	0.512	0.519
D	20.2			0.795		
N	60			2.362		
T			14.4			0.567
Ao	3.13	3.23	3.33	0.123	0.127	0.131
Bo	3.07	3.17	3.27	0.120	0.124	0.128
Ko	1.27	1.37	1.47	0.050	0.054	0.058
Po	3.9	4.0	4.1	0.153	0.157	0.161
P	3.9	4.0	4.1	0.153	0.157	0.161

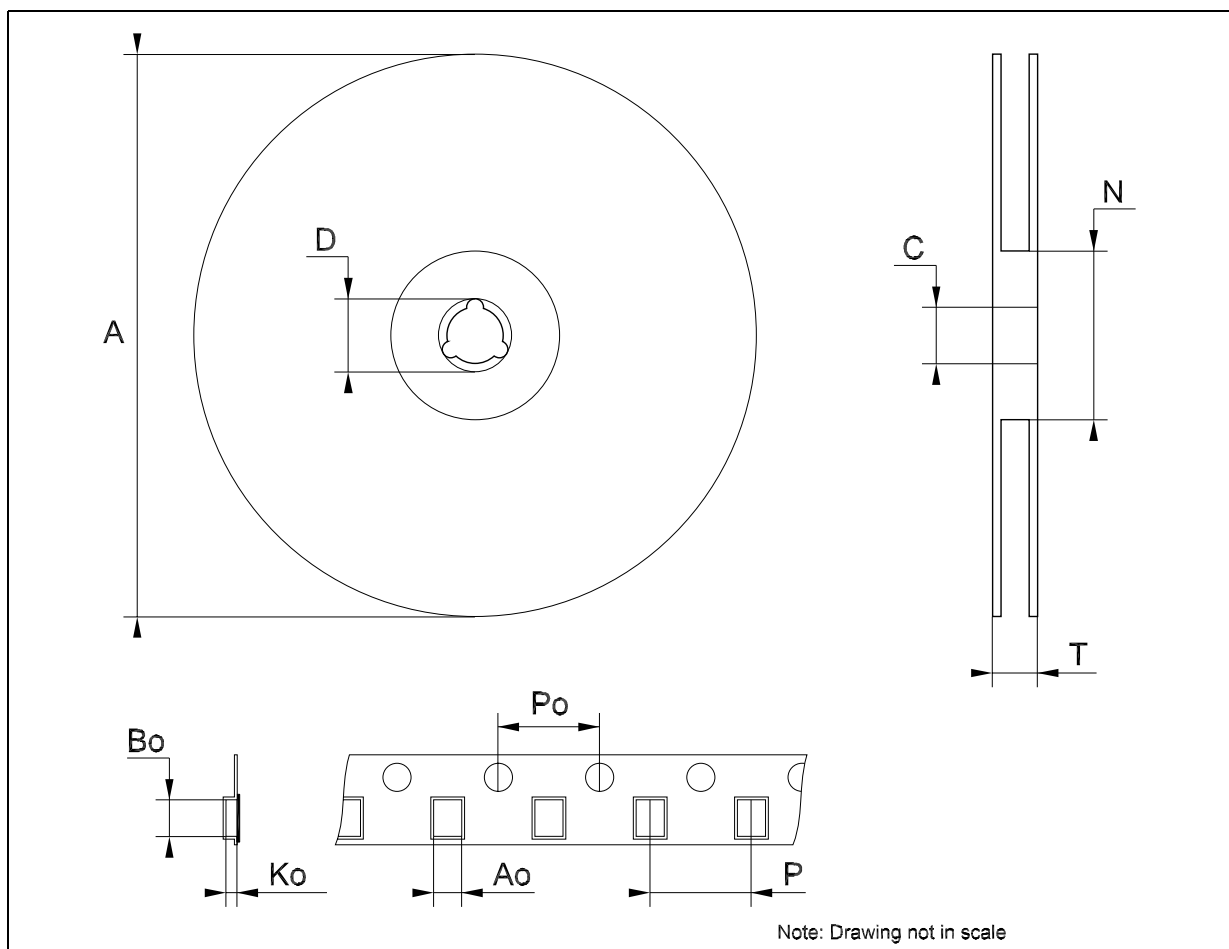

Information furnished is believed to be accurate and reliable. However, STMicroelectronics assumes no responsibility for the consequences of use of such information nor for any infringement of patents or other rights of third parties which may result from its use. No license is granted by implication or otherwise under any patent or patent rights of STMicroelectronics. Specifications mentioned in this publication are subject to change without notice. This publication supersedes and replaces all information previously supplied. STMicroelectronics products are not authorized for use as critical components in life support devices or systems without express written approval of STMicroelectronics.

© The ST logo is a registered trademark of STMicroelectronics

© 2003 STMicroelectronics - Printed in Italy - All Rights Reserved
STMicroelectronics GROUP OF COMPANIES

Australia - Brazil - Canada - China - Finland - France - Germany - Hong Kong - India - Israel - Italy - Japan - Malaysia - Malta - Morocco
Singapore - Spain - Sweden - Switzerland - United Kingdom - United States.

© <http://www.st.com>