



**μPC6012**  
**12-BIT HIGH-SPEED**  
**MULTIPLYING**  
**D/A CONVERTER**

**Description**

The μPC6012 monolithic multiplying digital-to-analog converter is designed to set new standards of speed and accuracy for 12-bit converters. This device is the first 12-bit DAC to use standard processing without the need of thin film resistors and/or active trimming of individual devices. The μPC6012 features high voltage compliance, and high impedance dual complementary outputs, which enable differential operation to effectively double the peak-to-peak output swing. The outputs can be used without op-amps in many applications.

**Features**

- Differential nonlinearity to ±0.025% FS max
- Fast setting time: 400 ns typical
- Full scale current 4 mA
- High output impedance and compliance: -5 to +10 V
- Differential current output
- High speed multiplying capability
- Direct interface to TTL, CMOS, ECL, HTL, NMOS
- Am6012 direct replacement

**Ordering Information**

Part Number	Package	Operating Temperature Range
μPC6012C	Plastic DIP	0°C to -70°C

**Absolute Maximum Ratings**

$T_A = 25^\circ C$

Power Supply Voltage Range, $V^+ - V^-$	36 V
Logic Input Voltage Range, $V^-$	-5 to -18 V
Output Voltage Range, $V_O$	-8 to +12 V
Reference Input Voltage Range, $V^- - REF$	$V^-$ to $V^-$
Reference Input Differential Voltage Range, $V^+ - REF - V^- - REF$	±18 V
Reference Input Current Range, $I_{REF}$	0 - 1.25 mA
Total Power Dissipation, $P_T$	500 mW
Operating Temperature Range	0 to +70°C
Storage Temperature Range	-55 to +125°C

**Comment:** Stress above those listed under "Absolute Maximum Ratings" may cause permanent damage to the device. This is a stress rating only and functional operation of the device at these or any other conditions above those indicated in the operational sections of this specification is not implied. Exposure to absolute maximum rating conditions for extended periods may affect device reliability.

**Pin Configuration**

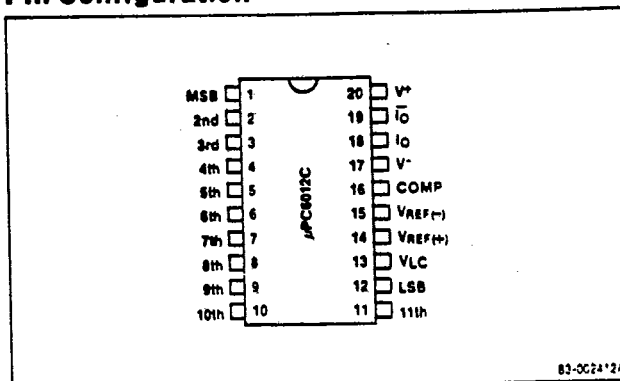

**Pin Identification Table**

Pin	Name	Function
1	MSB	Data Bit 1
2	2nd	Data Bit 2
3	3rd	Data Bit 3
4	4th	Data Bit 4
5	5th	Data Bit 5
6	6th	Data Bit 6
7	7th	Data Bit 7
8	8th	Data Bit 8
9	9th	Data Bit 9
10	10th	Data Bit 10
11	11th	Data Bit 11
12	LSB	Data Bit 12
13	VLC	Threshold Control
14	VREF+	Positive Reference Voltage
15	VREF-	Negative Reference Voltage
16	Compensation	Amp Compensation
17	V- Supply	Negative Supply Voltage
18	IO	Current Out +
19	IO	Current Out -
20	V+ Supply	Positive Supply Voltage



**μPC6012**

**Block Diagram**

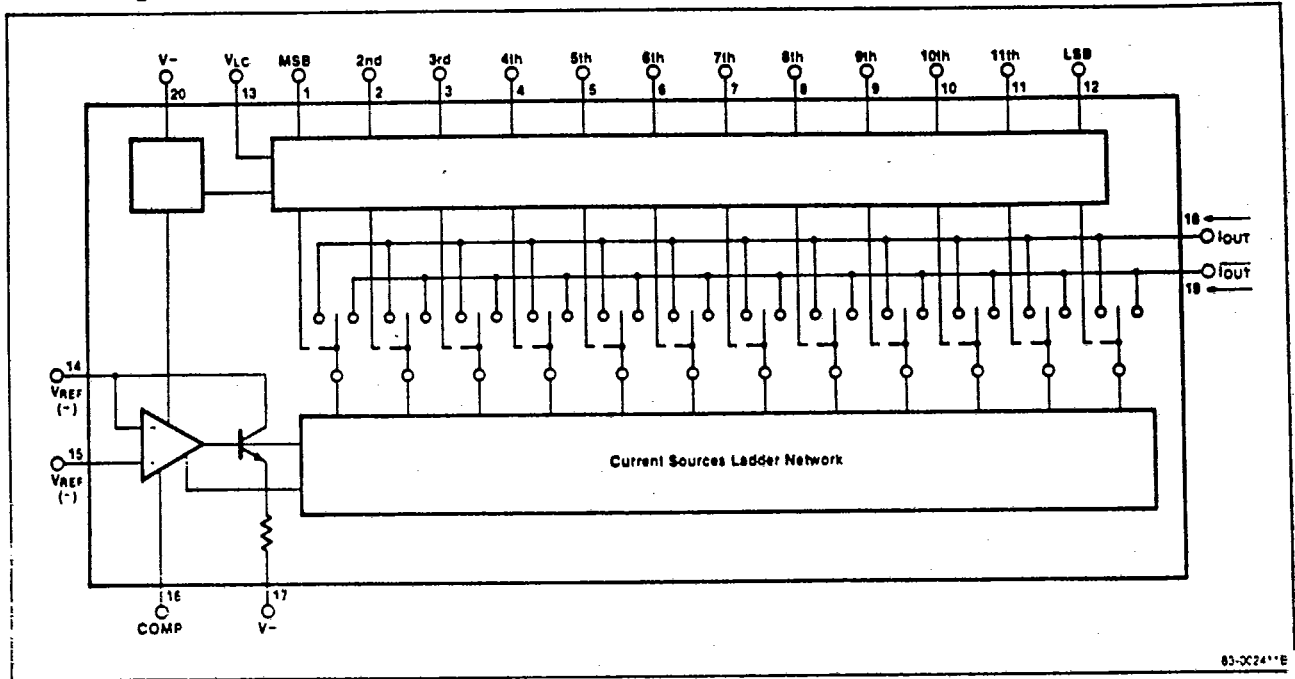

**Recommended Operating Conditions**

Parameter	Symbol	Limits			Unit	Test Conditions
		Min.	Typ.	Max.		
Power Supply Voltage	V <sup>-</sup>	+4.5	+15		V	
	V <sup>-</sup>		-15	-10.8	V	
Ambient Temperature	T <sub>A</sub>	0	-25	+70	°C	
Reference Input Current	I <sub>REF</sub>	0.2	1.0	1.1	mA	
High Level Input Voltage	V <sub>IH</sub>	+2.0		+18	V	V <sub>LC</sub> = 0 V
Low Level Input Voltage	V <sub>IL</sub>	-5.0		+0.8	V	V <sub>LC</sub> = 0 V
Output Voltage Compliance	V <sub>OC</sub>	-5.0	0	+10	V	DNL ≤ ±0.025% FSR

T-51-09-12

**NEC****μPC6012****Electrical Characteristics** $T_A = 0$  to  $70^\circ\text{C}$ ,  $V_{\pm} = \pm 15\text{ V}$ ,  $I_{REF} = 1.0000\text{ mA}$ 

Parameter	Symbol	Limits			Unit	Test Conditions
		Min.	Typ.	Max.		
Resolution		12	12	12	Bit	
Monotonicity		12	12	12	Bit	
Differential Nonlinearity	DNL			$\pm 0.025$	%FSR	
Nonlinearity	NL			$\pm 0.05$	%FSR	
Full Scale Output Current	$I_{FS}$	3.935	3.999	4.063	mA	$V_{REF} = 10.000\text{ V}$ , $T_A = 25^\circ\text{C}$ , $R_{14} = R_{15} = 10.000\text{ k}\Omega$
Full Scale Temperature Coefficient	$\frac{\Delta I_{FS}}{I_{FS} - \Delta T}$			$\pm 40$	ppm/ $^\circ\text{C}$	
Full Scale Symmetry	$I_{FS} - I_{FS}$			$\pm 2.0$	$\mu\text{A}$	
Zero Scale Current	$I_{ZS}$			0.10	$\mu\text{A}$	
Settling Time	$t_s$		400		ns	$\frac{1}{2}$ LSB, $T_A = 25^\circ\text{C}$ , all bits ON or OFF
Propagation Delay	$t_{PLH}$ , $t_{PHL}$			50	ns	50% to 50%
Output Capacitance	$C_O$		35		pF	
Logic Input Current	$I_{IK}$			40	$\mu\text{A}$	$-5\text{ V} < V_I < +18\text{ V}$
Reference Bias Current	$I_{b+}$			-2.0	$\mu\text{A}$	
Reference Input Slew Rate	$\Delta I_{REF}/\Delta t$	4.0	8.0		mA/ $\mu\text{s}$	$C_C = 0$ , $R_{14} = 800\ \Omega$
Supply Voltage Rejection Ratio	$ SVRR^- $			$\pm 0.001$	%FSR/ $\%$	$V^- = -13.5$ to $-16.5\text{ V}$ , $V^+ = -15\text{ V}$
	$ SVRR^+ $			$\pm 0.001$	%FSR/ $\%$	$V^- = -13.5$ to $-16.5\text{ V}$ , $V^+ = -15\text{ V}$
Power Supply Current	$I^{-1}$			8.5	mA	$V^- = +5\text{ V}$
	$I^{-1}$			-18.0	mA	$V^- = -15\text{ V}$
	$I^{-2}$			8.5	mA	$V^- = +15\text{ V}$
	$I^{-2}$			-18.0	mA	$V^- = -15\text{ V}$
Power Dissipation	$P_{D1}$			312	mW	$V^+ = +5\text{ V}$ , $V^- = -15\text{ V}$
	$P_{D2}$			397	mW	$V^+ = +15\text{ V}$ , $V^- = -15\text{ V}$



**μPC6012**

**Typical Applications**

There is a 1 to 4 scale factor between the reference current ( $I_{REF}$ ) and the full scale output current ( $I_{FS}$ ).

If  $V_{REF} = +10\text{ V}$  and  $I_{FS} = 4\text{ mA}$ , the value of the  $R_{REF}$  is:

$$R^+_{REF} = \frac{4 \times 10\text{ V}}{4\text{ mA}}$$

$$R^+_{REF} = R^-_{REF}$$

The compensation capacitor is a function of the impedance seen at the  $+V_{REF}$  input and is determined by the following expression:

$$C = (5\text{ pF}) (R^+_{REF} (\text{k}\Omega))$$

For  $R_{14} < 800\Omega$ , no capacitor is necessary.

**Positive Reference Voltage**

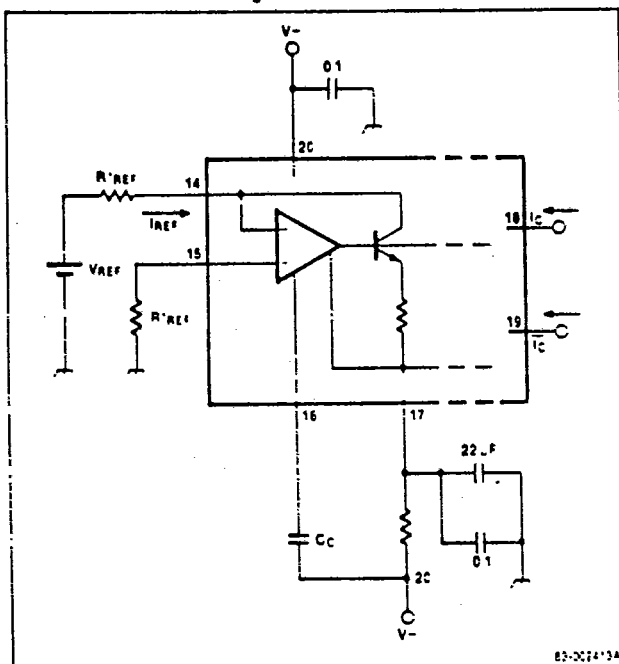

**Negative Reference Voltage**

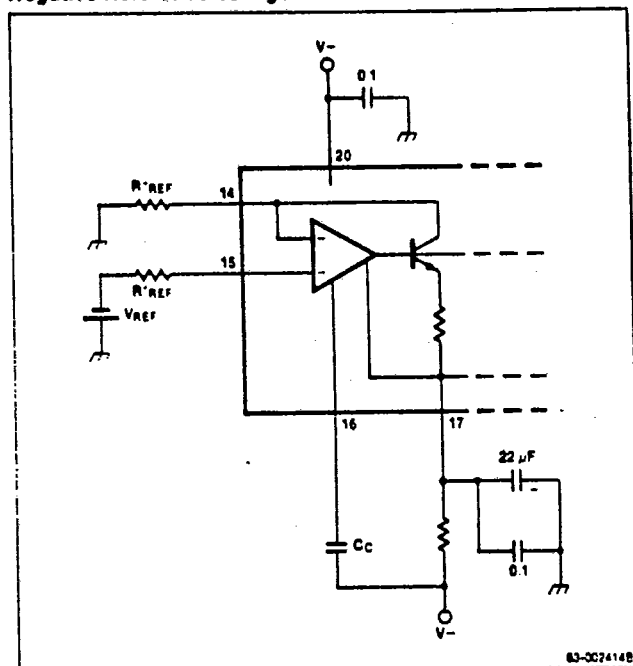

# NEC

## μPC6012

### Typical Applications (Cont.)

#### Unipolar Negative Output

$I_{REF} = 1.0000 \text{ mA}$

Input Code MSB	LSB	$I_O$ (mA)	$\bar{I}_O$ (mA)	$V_O$ (V)	$\bar{V}_O$ (V)
111111111111	1	3.999	0.000	-3.999	0.000
111111111110	0	3.998	0.001	-3.998	-0.001
100000000000	0	2.000	1.999	-2.000	-1.999
000000000001	1	0.001	3.998	-0.001	-3.998
000000000000	0	0.000	3.999	0.000	-3.999

μPC6012C

83-0024156

#### Bipolar Output

$I_{REF} = 1.0000 \text{ mA}$

Input Code MSB	LSB	$I_O$ (mA)	$\bar{I}_O$ (mA)	$V_O$ (V)	$\bar{V}_O$ (V)
111111111111	1	3.999	0.000	-1.999	+2.000
111111111110	0	3.998	0.001	-1.998	+1.999
100000000001	1	2.001	1.998	-0.001	+0.002
100000000000	0	2.000	1.999	0.000	+0.001
011111111111	1	1.999	2.000	+0.001	0.000
000000000001	1	0.001	3.998	+1.999	-1.998
000000000000	0	0.000	3.999	+2.000	-1.999

μPC6012C

83-0024168

**μPC6012**



**Typical Applications (Cont.)**

**Unipolar Positive Output (Straight Binary)**

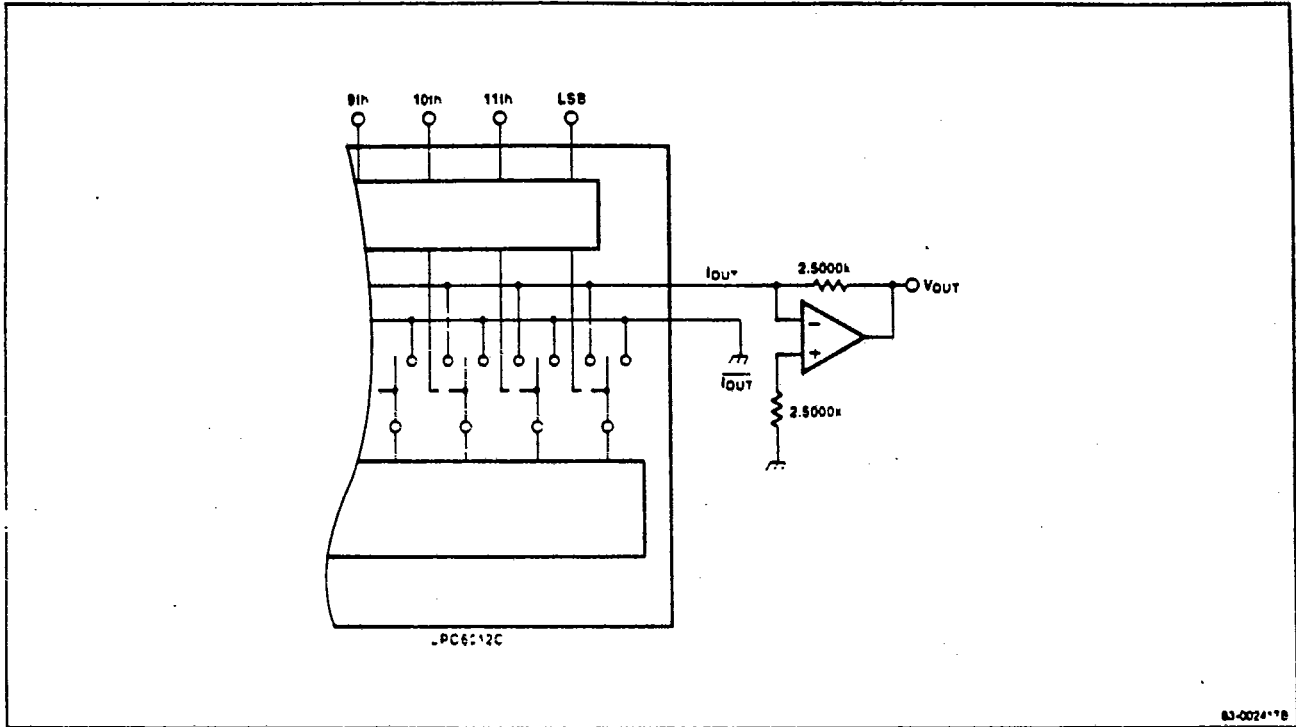

**Unipolar Negative Output (Complementary Binary)**

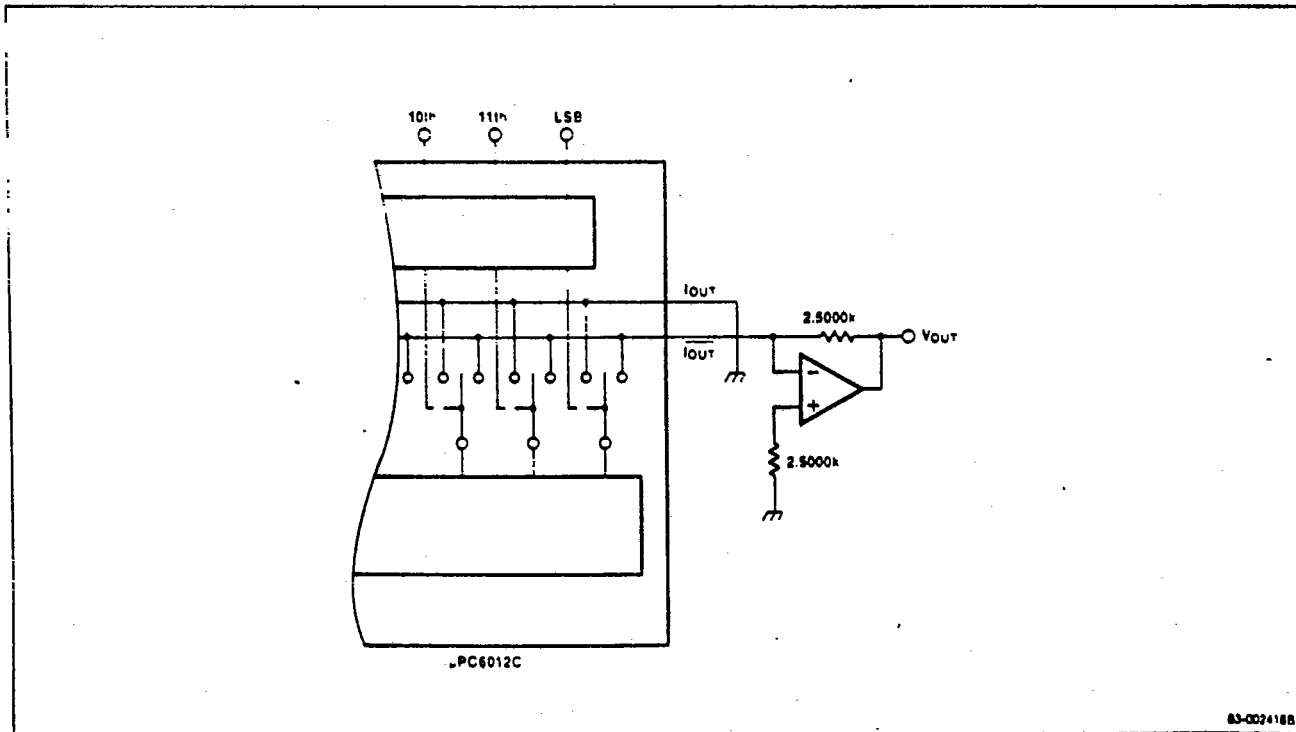

# NEC

## μPC6012

### Typical Applications (Cont.)

#### Symmetrical Offset

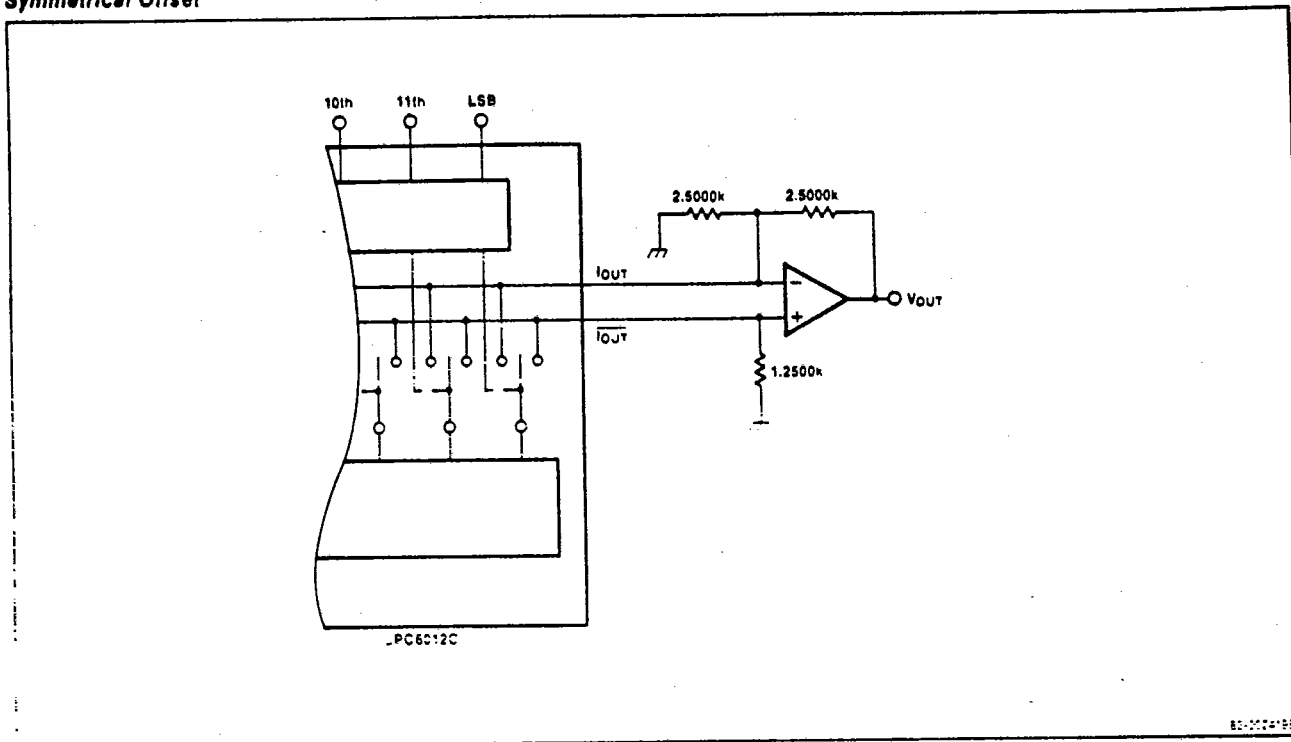

82-0001188