

# PNZ330CL

## PIN Photodiode

For optical fiber communication systems

### ■ Features

- TO-18 standard type package
- High coupling capability suitable for plastic fiber
- High quantum efficiency
- High-speed response

### ■ Absolute Maximum Ratings (Ta = 25°C)

Parameter	Symbol	Ratings	Unit
Reverse voltage (DC)	$V_R$	30	V
Power dissipation	$P_D$	100	mW
Operating ambient temperature	$T_{opr}$	-25 to +85	°C
Storage temperature	$T_{stg}$	-30 to +100	°C

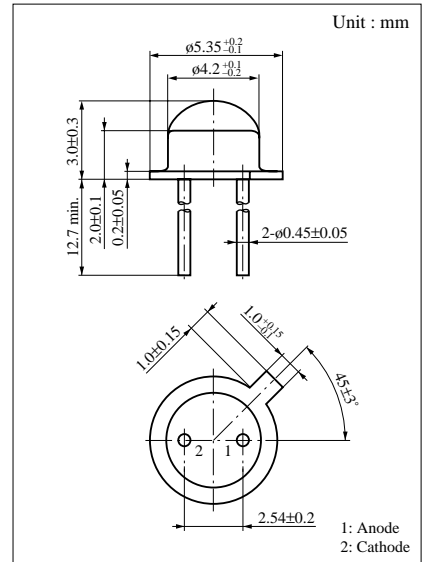

### ■ Dimensions of detection area

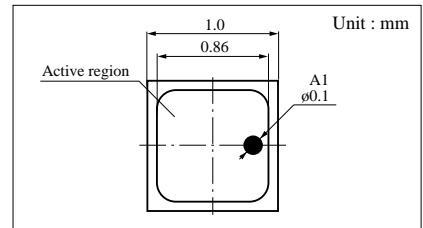

### ■ Electro-Optical Characteristics (Ta = 25°C)

Parameter	Symbol	Conditions	min	typ	max	Unit
Dark current	$I_D$	$V_R = 10V$		0.1	10	nA
Photo current	$I_L$	$V_R = 10V, L = 1000 \text{ lx}^{*1}$	7	10		$\mu A$
Peak sensitivity wavelength	$\lambda_p$	$V_R = 10V$		850		nm
Response time	$t_r, t_f^{*2}$	$V_R = 10V, R_L = 50\Omega$		2		ns
Capacitance between pins	$C_t$	$V_R = 10V, f = 1MHz$		7		pF
Acceptance half angle	$\theta$	Measured from the optical axis to the half power point		70		deg.

\*1 Measurements were made using a tungsten lamp (color temperature T = 2856K) as a light source.

\*2 Switching time measurement circuit

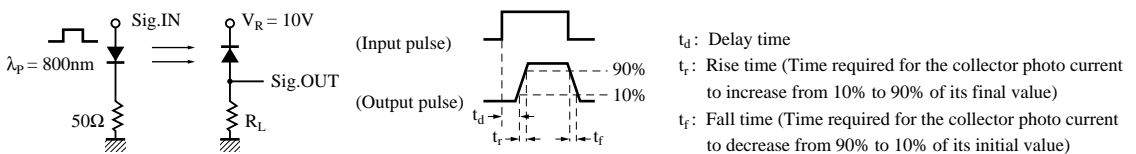

Note) Difficult to guarantee compliance with moisture resistance standard (MIL-STD-202D)

$I_L - L$

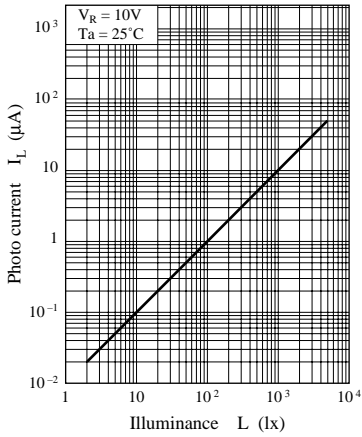

$I_L - V_R$

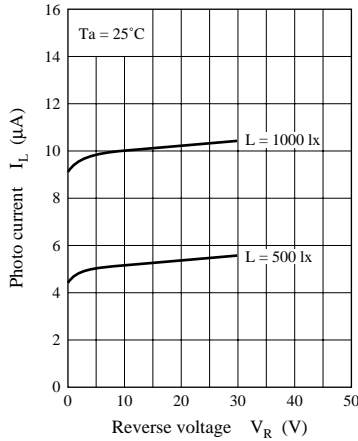

$I_L - T_a$

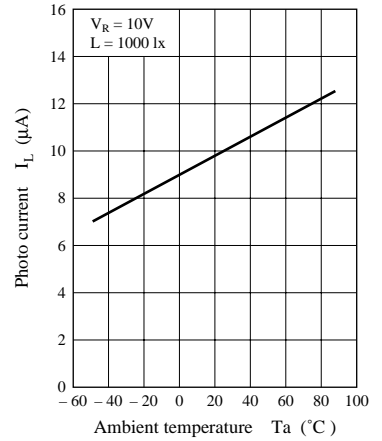

$I_D - T_a$

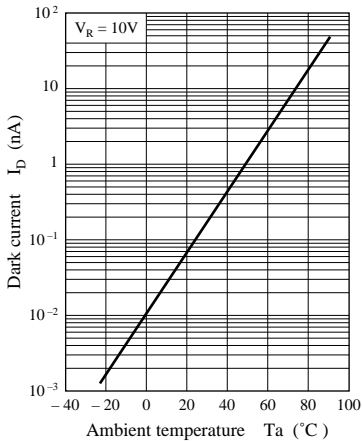

$t_r, t_f - R_L$

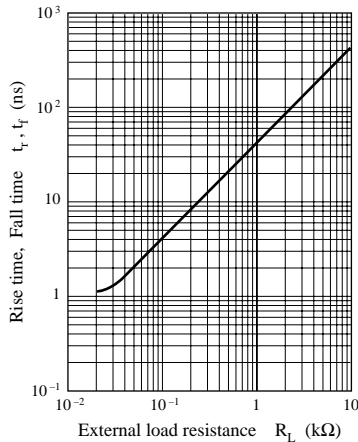

Spectral sensitivity characteristics

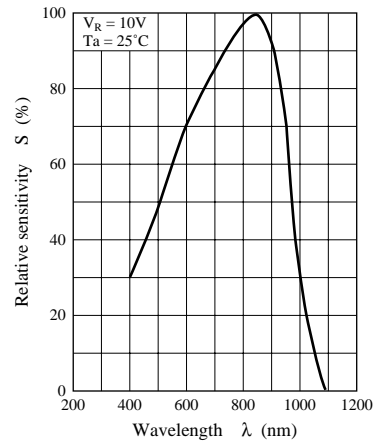

Directivity characteristics

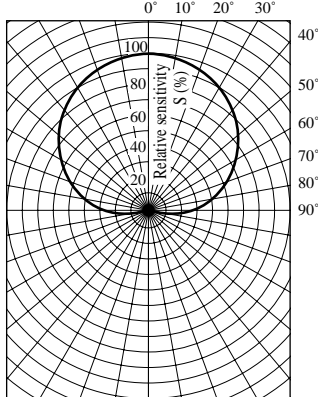

Coupling loss characteristics

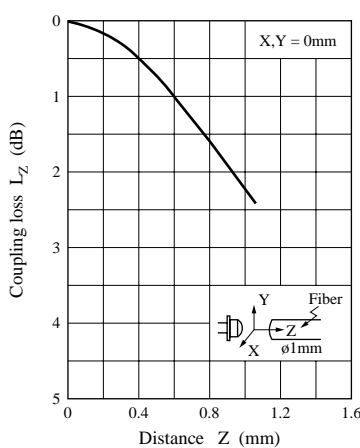

Coupling loss characteristics

