

## 60A, 30V, 0.027 Ohm, P-Channel Power MOSFETs

These P-Channel power MOSFETs are manufactured using the MegaFET process. This process, which uses feature sizes approaching those of LSI integrated circuits gives optimum utilization of silicon, resulting in outstanding performance. They were designed for use in applications such as switching regulators, switching converters, motor drivers and relay drivers. These transistors can be operated directly from integrated circuits.

Formerly developmental type TA49045.

### Ordering Information

PART NUMBER	PACKAGE	BRAND
RFG60P03	TO-247	RFG60P03
RFP60P03	TO-220AB	RFP60P03
RF1S60P03SM	TO-263AB	F1S60P03

NOTE: When ordering, use the entire part number. Add the suffix 9A to obtain the TO-263AB variant in tape and reel, i.e. RF1S60P03SM9A.

### Features

- 60A, 30V
- $r_{DS(ON)} = 0.027\Omega$
- Temperature Compensating PSPICE® Model
- Peak Current vs Pulse Width Curve
- UIS Rating Curve
- 175°C Operating Temperature
- Related Literature
  - TB334 "Guidelines for Soldering Surface Mount Components to PC Boards"

### Symbol

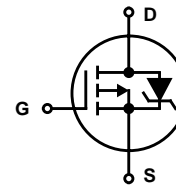

### Packaging

JEDEC STYLE TO-247

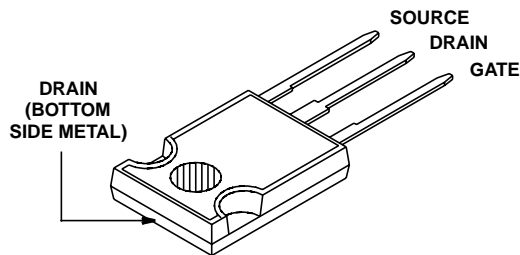

JEDEC TO-220AB

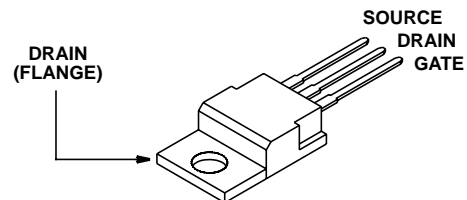

JEDEC TO-263AB

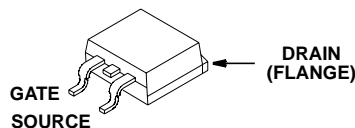

# RFG60P03, RFP60P03, RF1S60P03SM

## Absolute Maximum Ratings $T_C = 25^\circ\text{C}$ , Unless Otherwise Specified

	RFG60P03, RFP60P03, RFS60P03SM	UNITS
Drain to Source Voltage (Note 1) . . . . .	$V_{DS}$ -30	V
Drain to Gate Voltage, ( $R_{GS} = 20\text{k}\Omega$ ) (Note 1) . . . . .	$V_{DGR}$ -30	V
Gate to Source Voltage . . . . .	$V_{GS}$ $\pm 20$	V
Continuous Drain Current (Figure 2) . . . . .	$I_D$ 60	A
Pulsed Drain Current (Note 3) . . . . .	$I_{DM}$ Refer to Peak Current Curve	
Single Pulse Avalanche Rating . . . . .	$E_{AS}$ Figure 6	
Maximum Power Dissipation (Figure 1) . . . . .	$P_D$ 176	W
Derate Above $25^\circ\text{C}$ . . . . .	1.17	W/ $^\circ\text{C}$
Operating and Storage Temperature . . . . .	$T_J, T_{STG}$ -55 to 175	$^\circ\text{C}$
Maximum Temperature for Soldering		
Leads at 0.063in (1.6mm) from Case for 10s . . . . .	$T_L$ 300	$^\circ\text{C}$
Package Body for 10s, See Techbrief 334 . . . . .	$T_{pkg}$ 260	$^\circ\text{C}$

CAUTION: Stresses above those listed in "Absolute Maximum Ratings" may cause permanent damage to the device. This is a stress only rating and operation of the device at these or any other conditions above those indicated in the operational sections of this specification is not implied.

NOTE:

- $T_J = 25^\circ\text{C}$  to  $150^\circ\text{C}$ .

## Electrical Specifications $T_C = 25^\circ\text{C}$ , Unless Otherwise Specified

PARAMETER	SYMBOL	TEST CONDITIONS	MIN	TYP	MAX	UNITS
Drain to Source Breakdown Voltage	$BV_{DSS}$	$I_D = 250\mu\text{A}, V_{GS} = 0\text{V}$ (Figure 11)	-30	-	-	V
Gate Threshold Voltage	$V_{GS(TH)}$	$V_{GS} = V_{DS}, I_D = 250\mu\text{A}$ (Figure 10)	-2	-	-4	V
Zero Gate Voltage Drain Current	$I_{DSS}$	$V_{DS} = \text{Rated } BV_{DSS}, V_{GS} = 0\text{V}$	-	-	-1	$\mu\text{A}$
		$V_{DS} = 0.8 \times \text{Rated } BV_{DSS}, T_C = 150^\circ\text{C}$	-	-	-50	$\mu\text{A}$
Gate to Source Leakage Current	$I_{GSS}$	$V_{GS} = \pm 20\text{V}$	-	-	$\pm 100$	nA
Drain to Source On Resistance (Note 2)	$r_{DS(ON)}$	$I_D = 60\text{A}, V_{GS} = 10\text{V}$	-	-	0.027	$\Omega$
Turn-On Time	$t_{ON}$	$V_{DD} = 15\text{V}, I_D \approx 60\text{A}, R_L = 0.25\Omega,$ $V_{GS} = -10\text{V}, R_G = 2.5\Omega,$ (Figure 13)	-	-	140	ns
Turn-On Delay Time	$t_{d(ON)}$		-	20	-	ns
Rise Time	$t_r$		-	75	-	ns
Turn-Off Delay Time	$t_{d(OFF)}$		-	35	-	ns
Fall Time	$t_f$		-	40	-	ns
Turn-Off Time	$t_{OFF}$		-	-	115	ns
Total Gate Charge	$Q_g(\text{TOT})$	$V_{GS} = 0$ to $-20\text{V}$	-	190	230	nC
Gate Charge at 10V	$Q_g(-10)$	$V_{GS} = 0$ to $-10\text{V}$				
Threshold Gate Charge	$Q_g(\text{TH})$	$V_{GS} = 0$ to $-2\text{V}$				
Input Capacitance	$C_{ISS}$	$V_{DS} = 25\text{V}, V_{GS} = 0\text{V}, f = 1\text{MHz}$ (Figure 12)	-	3000	-	pF
Output Capacitance	$C_{OSS}$		-	1500	-	pF
Reverse Transfer Capacitance	$C_{RSS}$		-	525	-	pF
Thermal Resistance, Junction to Case	$R_{\theta JC}$	(Figure 3)	-	-	0.85	$^\circ\text{C/W}$
Thermal Resistance, Junction to Ambient	$R_{\theta JA}$	TO-220AB, TO-263AB	-	-	62	$^\circ\text{C/W}$
		TO-247	-	-	30	$^\circ\text{C/W}$

## Source to Drain Diode Specifications

PARAMETER	SYMBOL	TEST CONDITIONS	MIN	TYP	MAX	UNITS
Source to Drain Diode Voltage (Note 2)	$V_{SD}$	$I_{SD} = -60\text{A}$	-	-	-1.75	V
Diode Reverse Recovery Time	$t_{rr}$	$I_{SD} = -60\text{A}, dI_{SD}/dt = 100\text{A}/\mu\text{s}$	-	-	200	ns

NOTE:

- Pulse test: pulse width  $\leq 300\mu\text{s}$ , duty cycle  $\leq 2\%$ .
- Repetitive rating: pulse width limited by maximum junction temperature. See Transient Thermal Impedance curve (Figure 3)

Typical Performance Curves Unless Otherwise Specified

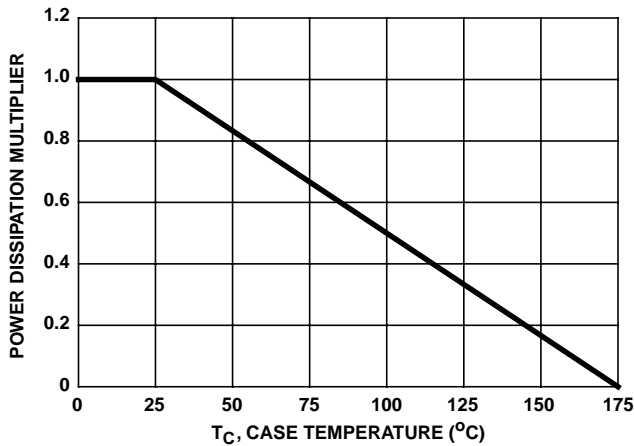

FIGURE 1. NORMALIZED POWER DISSIPATION vs CASE TEMPERATURE

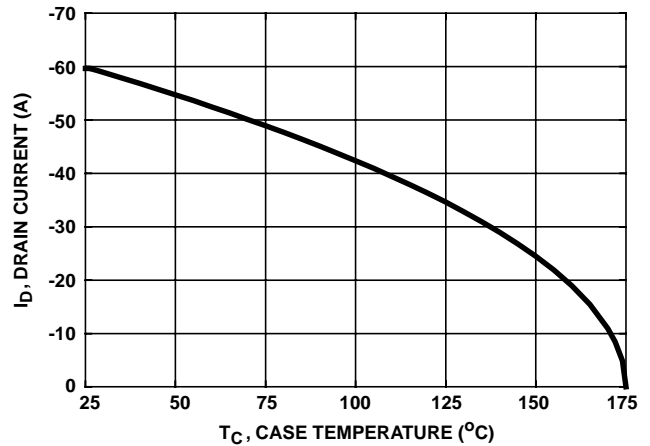

FIGURE 2. MAXIMUM CONTINUOUS DRAIN CURRENT vs CASE TEMPERATURE

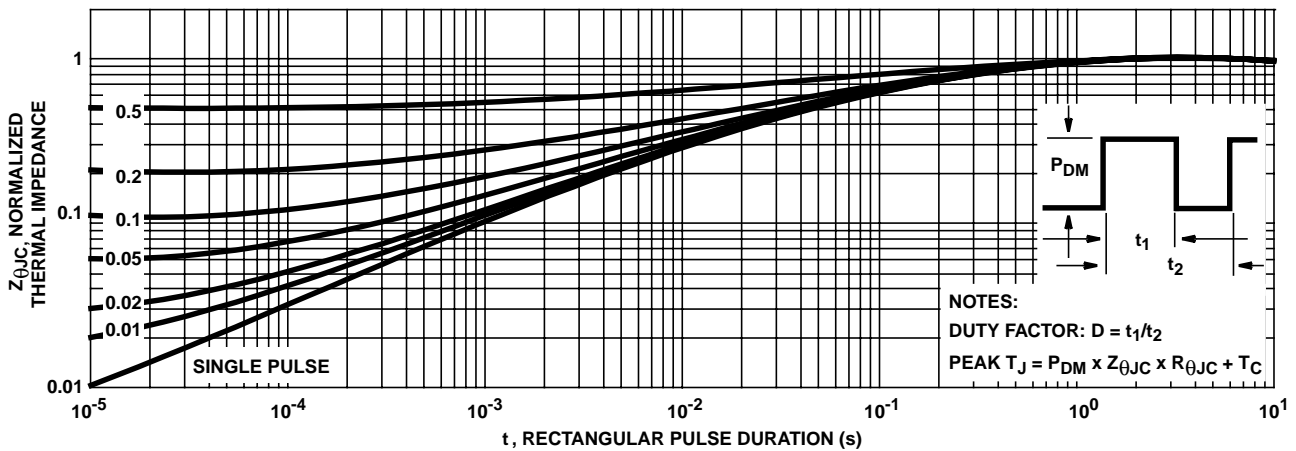

FIGURE 3. NORMALIZED MAXIMUM TRANSIENT THERMAL IMPEDANCE

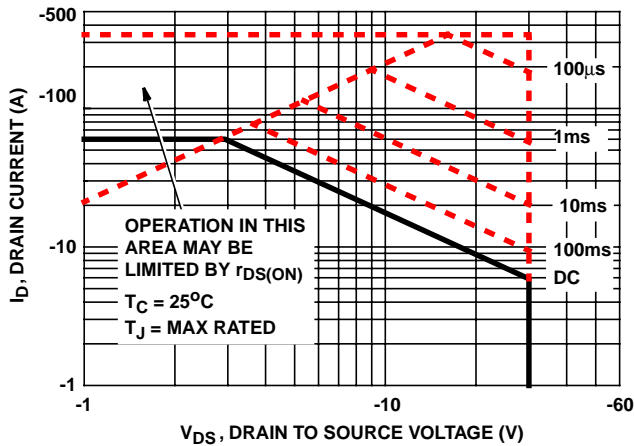

FIGURE 4. FORWARD BIAS SAFE OPERATING AREA

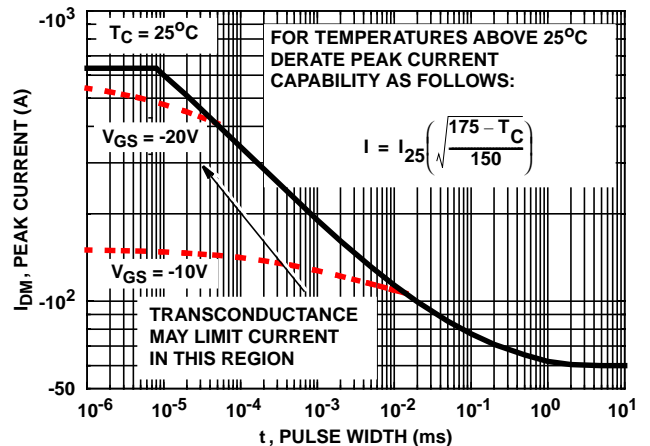
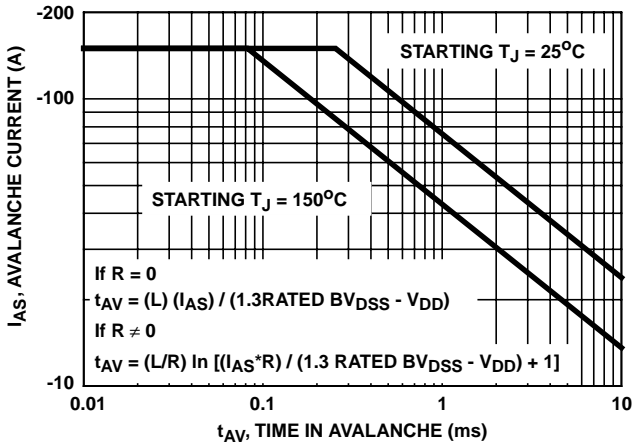

FIGURE 5. PEAK CURRENT CAPABILITY

Typical Performance Curves Unless Otherwise Specified (Continued)



NOTE: Refer to Intersil Application Notes AN9321 and AN9322.

FIGURE 6. UNCLAMPED INDUCTIVE SWITCHING

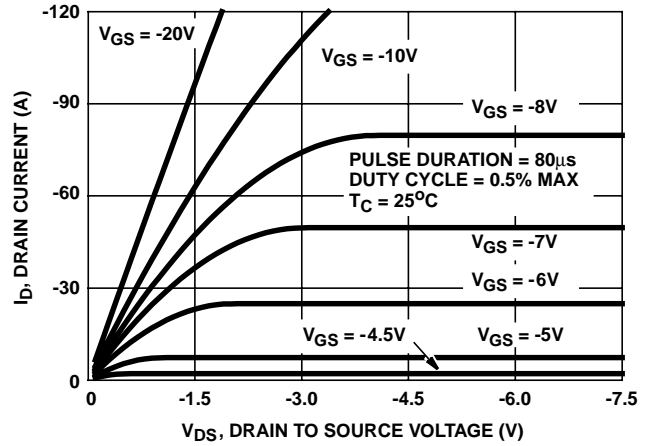

FIGURE 7. SATURATION CHARACTERISTICS

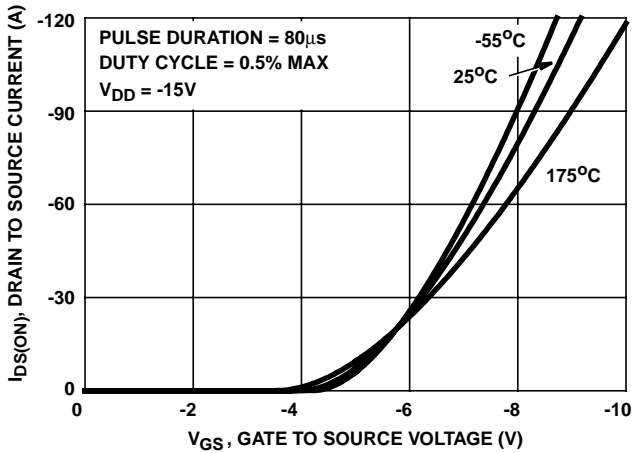

FIGURE 8. TRANSFER CHARACTERISTICS

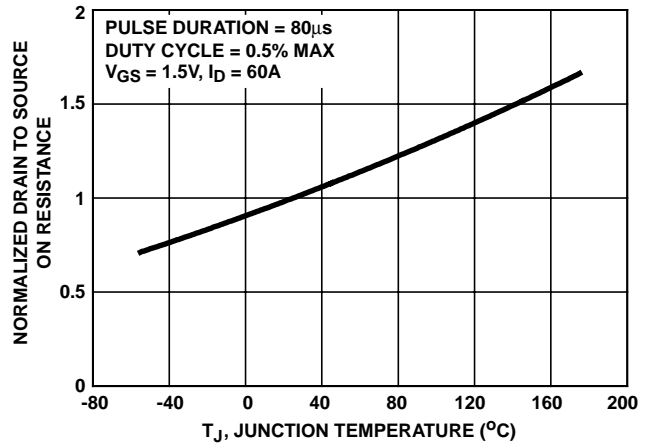

FIGURE 9. NORMALIZED DRAIN TO SOURCE ON RESISTANCE vs JUNCTION TEMPERATURE

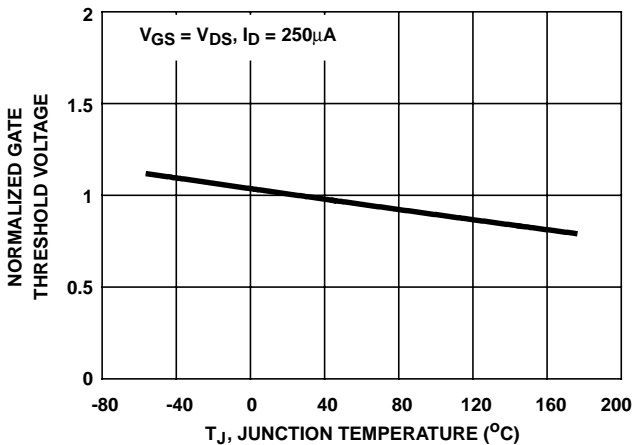

FIGURE 10. NORMALIZED GATE THRESHOLD VOLTAGE vs JUNCTION TEMPERATURE

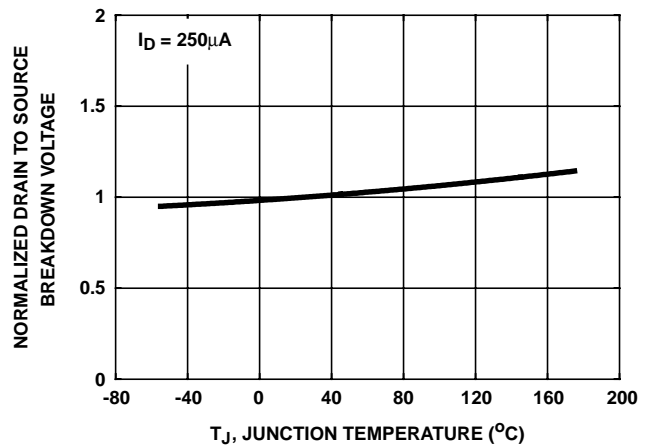

FIGURE 11. NORMALIZED DRAIN TO SOURCE BREAKDOWN VOLTAGE vs JUNCTION TEMPERATURE

**Typical Performance Curves** Unless Otherwise Specified (Continued)

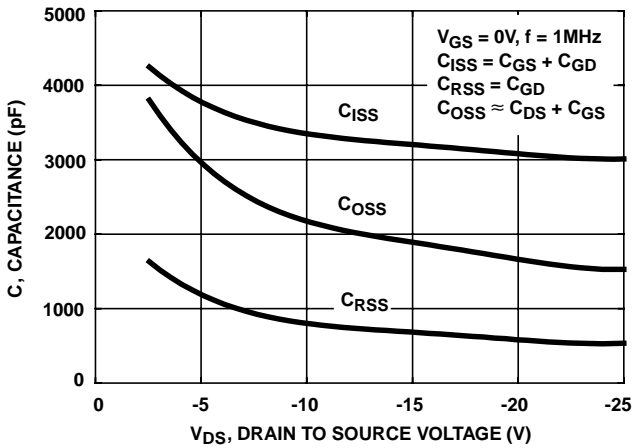
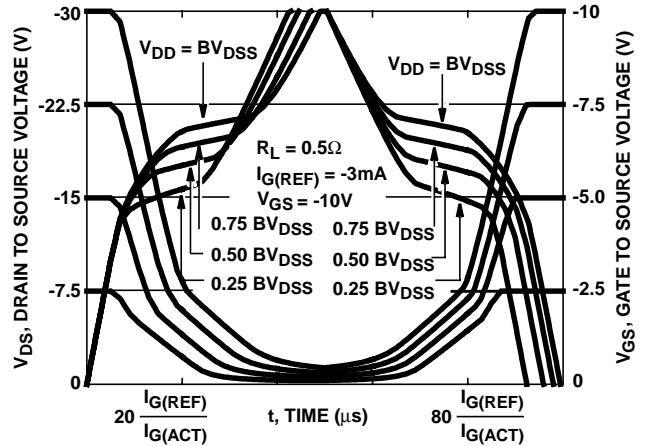

FIGURE 12. CAPACITANCE vs DRAIN TO SOURCE VOLTAGE



NOTE: Refer to Intersil Application Notes AN7254 and AN7260.

FIGURE 13. NORMALIZED SWITCHING WAVEFORMS FOR CONSTANT GATE CURRENT

**Test Circuits and Waveforms**

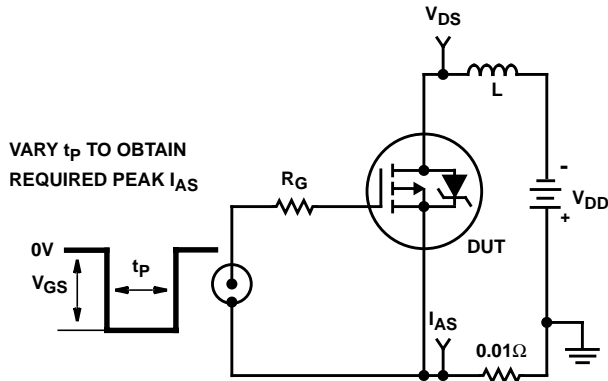

FIGURE 14. UNCLAMPED ENERGY TEST CIRCUIT

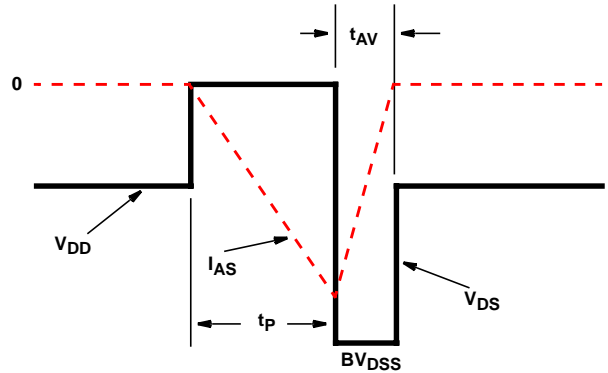

FIGURE 15. UNCLAMPED ENERGY WAVEFORM

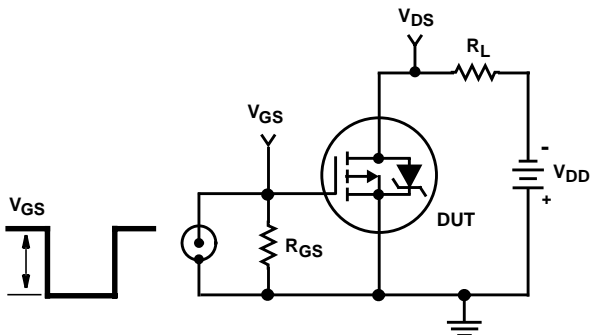

FIGURE 16. SWITCHING TIME TEST CIRCUIT

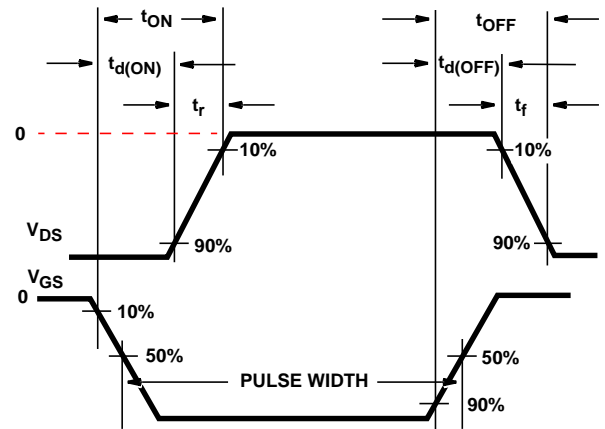

FIGURE 17. RESISTIVE SWITCHING WAVEFORMS

Test Circuits and Waveforms (Continued)

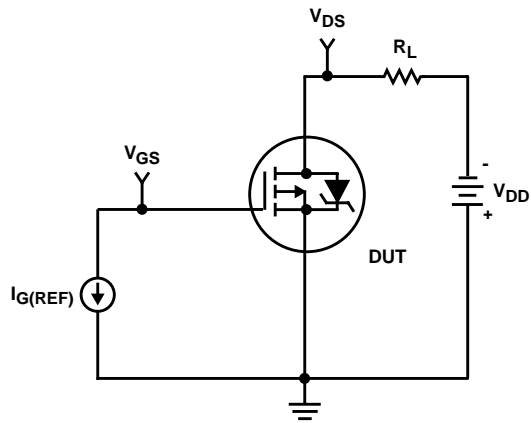

FIGURE 18. GATE CHARGE TEST CIRCUIT

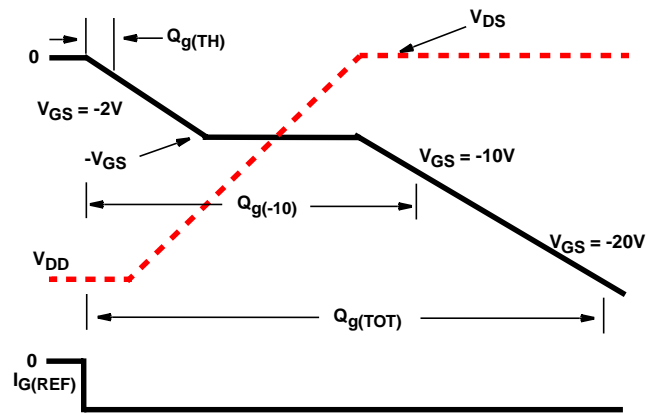

FIGURE 19. GATE CHARGE WAVEFORMS

**PSPICE Electrical Model**

.SUBCKT RFP60P03 2 1 3

REV 6/21/94

CA 12 8 5.01e-9  
 CB 15 14 3.9e-9  
 CIN 6 8 3.09e-9

DBODY 5 7 DBDMOD  
 DBREAK 7 11 DBKMOD  
 DPLCAP 10 6 DPLCAPMOD

EBREAK 5 11 17 18 -36.59  
 EDS 14 8 5 8 1  
 EGS 13 8 6 8 1  
 ESG 5 10 8 6 1  
 EVTO 20 6 8 18 1

IT 8 17 1

LDRAIN 2 5 1e-9  
 LGATE 1 9 4.92e-9  
 LSOURCE 3 7 2.36e-9

MOS1 16 6 8 8 MOSMOD M=0.99  
 MOS2 16 21 8 8 MOSMOD M=0.01

RBREAK 17 18 RBKMOD 1  
 RDRAIN 5 16 RDSMOD 1e-4  
 RGATE 9 20 3.25  
 RIN 6 8 1e9  
 RSOURCE 8 7 RDSMOD 11.28e-3  
 RVTO 18 19 RVTOMOD 1

S1A 6 12 13 8 S1AMOD  
 S1B 13 12 13 8 S1BMOD  
 S2A 6 15 14 13 S2AMOD  
 S2B 13 15 14 13 S2BMOD

VBAT 8 19 DC 1  
 VTO 21 6 -0.92

.MODEL DBDMOD D (IS=4.21e-13 RS=1e-2 TRS1=-2.69e-4 TRS2=-1.33e-6 CJO=5.05e-9 TT=5.33e-8)  
 .MODEL DBKMOD D (RS=3.80e-2 TRS1=-4.76e-4 TRS2=-4.17e-12)  
 .MODEL DPLCAPMOD D (CJO=4.05e-9 IS=1e-30 N=10)  
 .MODEL MOSMOD PMOS (VTO=-3.98 KP=16.27 IS=1e-30 N=10 TOX=1 L=1u W=1u)  
 .MODEL RBKMOD RES (TC1=8.05e-4 TC2=1.48e-6)  
 .MODEL RDSMOD RES (TC1=2.80e-3 TC2=2.62e-6)  
 .MODEL RVTOMOD RES (TC1=-3.34e-3 TC2=1.46e-6)  
 .MODEL S1AMOD VSWITCH (RON=1e-5 ROFF=0.1 VON=7.5 VOFF=4.5)  
 .MODEL S1BMOD VSWITCH (RON=1e-5 ROFF=0.1 VON=4.5 VOFF=7.5)  
 .MODEL S2AMOD VSWITCH (RON=1e-5 ROFF=0.1 VON=1.43 VOFF=-3.57)  
 .MODEL S2BMOD VSWITCH (RON=1e-5 ROFF=0.1 VON=-3.57 VOFF=1.43)

.ENDS

NOTE: For further discussion of the PSPICE model consult **A New PSPICE Sub-Circuit for the Power MOSFET Featuring Global Temperature Options**; authors, William J. Hepp and C. Frank Wheatley.

All Intersil semiconductor products are manufactured, assembled and tested under **ISO9000** quality systems certification.

*Intersil semiconductor products are sold by description only. Intersil Corporation reserves the right to make changes in circuit design and/or specifications at any time without notice. Accordingly, the reader is cautioned to verify that data sheets are current before placing orders. Information furnished by Intersil is believed to be accurate and reliable. However, no responsibility is assumed by Intersil or its subsidiaries for its use; nor for any infringements of patents or other rights of third parties which may result from its use. No license is granted by implication or otherwise under any patent or patent rights of Intersil or its subsidiaries.*

For information regarding Intersil Corporation and its products, see web site <http://www.intersil.com>

