

Surface Mount N-Channel Enhancement Mode MOSFET

(Pb) Lead(Pb)-Free

Features:

*Super high dense cell design for low $R_{DS(ON)}$

$R_{DS(ON)} < 7 \text{ m}\Omega @ V_{GS} = 10\text{V}$

$R_{DS(ON)} < 9 \text{ m}\Omega @ V_{GS} = 4.5\text{V}$

*Rugged and Reliable

*SO-8 Package

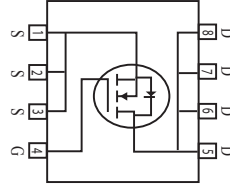

DRAIN CURRENT
14 AMPERES
DRAIN SOURCE VOLTAGE
25 VOLTAGE

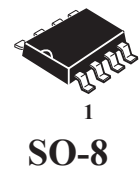

Maximum Ratings (TA=25 °C Unless Otherwise Specified)

Rating	Symbol	Value	Unit
Drain-Source Voltage Rating	V_{Spike}^4	30	V
Drain-Source Voltage	V_{DS}	25	V
Gate-Source Voltage	V_{GS}	± 16	V
Continuous Drain Current ($T_J = 125^\circ\text{C}$) ⁽¹⁾	I_D	14	A
Pulsed Drain Current ⁽²⁾	I_{DM}	56	A
Drain-Source Diode Forward Current ⁽¹⁾	I_S	14	A
Power Dissipation ⁽¹⁾	P_D	2.5	W
Maximax Junction-to-Ambient ⁽¹⁾	$R_{\theta JA}$	50	$^\circ\text{C/W}$
Operating Junction and Storage Temperature Range	T_J, T_{stg}	-55 to 150	$^\circ\text{C}$

Device Marking

WT7822AM=STM7822A

Electrical Characteristics (T_A=25 °C Unless otherwise noted)

Characteristic	Symbol	Min	Typ	Max	Unit
----------------	--------	-----	-----	-----	------

Static (2)

Drain-Source Breakdown Voltage V _{GS} =0V, I _D =250μA	V _{(BR)DSS}	25	-	-	V
Gate-Source Threshold Voltage V _{DS} =V _{GS} , I _D =250μA	V _{GS(th)}	0.7	1.2	2.0	V
Gate-Source Leakage Current V _{DS} =0V, V _{GS} =±16V	I _{GSS}	-	-	±100	nA
Zero Gate Voltage Drain Current V _{DS} =20V, V _{GS} =0V	I _{DSS}	-	-	1	uA
Drain-Source On-Resistance V _{GS} =10V, I _D =14A V _{GS} =4.5V, I _D =10A	r _{DS(on)}	- -	6 8	7 9	mΩ
On-State Drain Current V _{DS} =10V, V _{GS} =10V	I _{D(on)}	10	-	-	A
Forward Transconductance V _{DS} =10V, I _D =14A	g _{fs}	-	28	-	S

Dynamic(3)

Input Capacitance V _{DS} =16V, V _{GS} =0V, f=1MHZ	C _{iss}	-	3640	-	PF
Output Capacitance V _{DS} =16V, V _{GS} =0V, f=1MHZ	C _{oss}	-	550	-	
Reverse Transfer Capacitance V _{DS} =16V, V _{GS} =0V, f=1MHZ	C _{rss}	-	420	-	

Switching (3)

Turn-On Delay Time V _{GS} =5V, V _{DD} =16V, I _D =14A, R _{GEN} =6Ω	t _{d(on)}	-	12.3	-	nS
Rise Time V _{GS} =5V, V _{DD} =16V, I _D =14A, R _{GEN} =6Ω	t _r	-	10.2	-	nS
Turn-Off Time V _{GS} =5V, V _{DD} =16V, I _D =14A, R _{GEN} =6Ω	t _{d(off)}	-	23.8	-	nS
Fall Time V _{GS} =5V, V _{DD} =16V, I _D =14A, R _{GEN} =6Ω	t _f	-	12.1	-	nS
Total Gate Charge V _{GS} =10V, V _{DS} =16V, I _D =14A V _{GS} =5V, V _{DS} =16V, I _D =14A	Q _g	- -	73.9 36.2	- -	nc
Gate-Source Charge V _{GS} =5V, V _{DS} =16V, I _D =14A	Q _{gs}	-	11.2	-	nc
Gate-Drain Charge V _{GS} =5V, V _{DS} =16V, I _D =14A	Q _{gd}	-	9.9	-	nc
Drain-Source Diode Forward Voltage V _{GS} =0V, I _S =14A	V _{SD}	-	0.84	1.2	V

- Note: 1. Surface Mounted on FR4 Board t ≤ 10sec.
 2. Pulse Test : PW ≤ 300us, Duty Cycle ≤ 2%.
 3. Guaranteed by Design, not Subject to Production Testing.
 4. Guaranteed when external R_g=6Ω and t_f < t_f max.

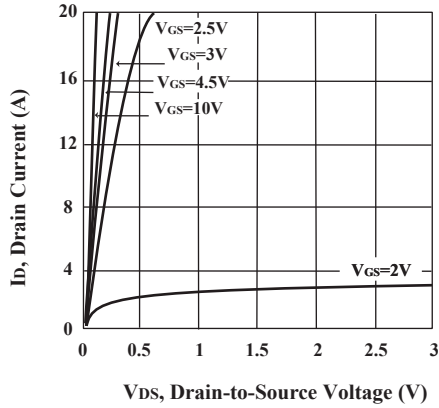

Fig.1 Output Characteristics

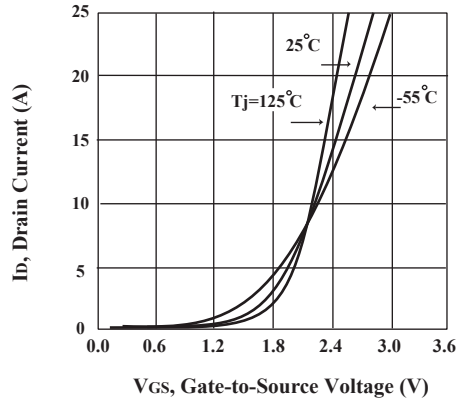

Fig.2 Transfer Characteristics

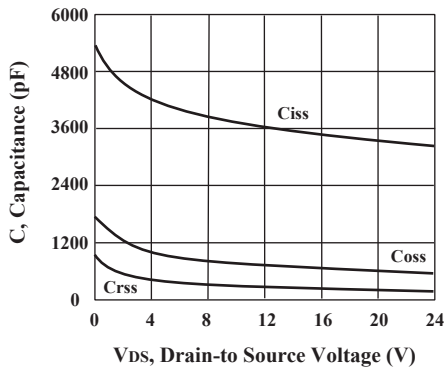

Fig.3 Capacitance

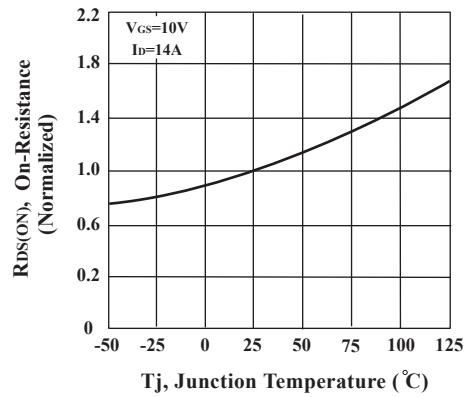

Fig.4 On-Resistance Variation with Temperature

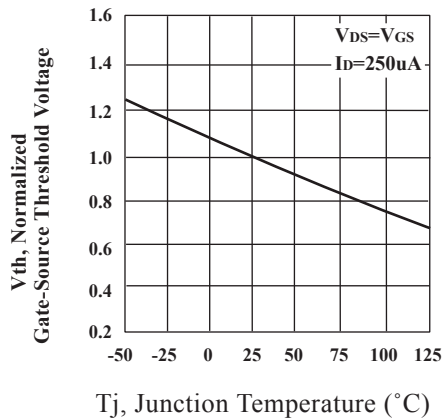

Fig.5 Gate Threshold Variation with Temperature

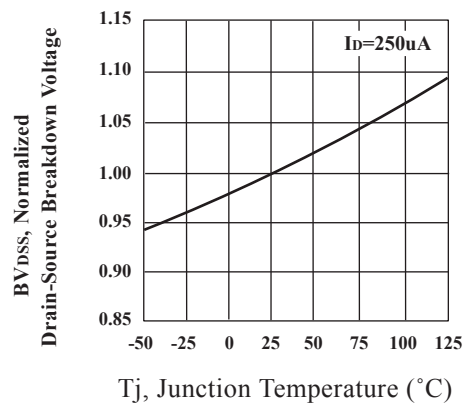

Fig.6 Breakdown Voltage Variation with Temperature

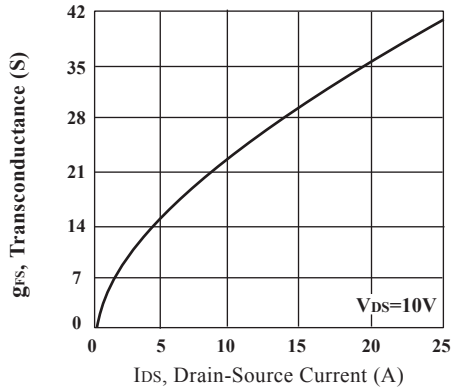

Fig.7 Transconductance Variation with Drain Current

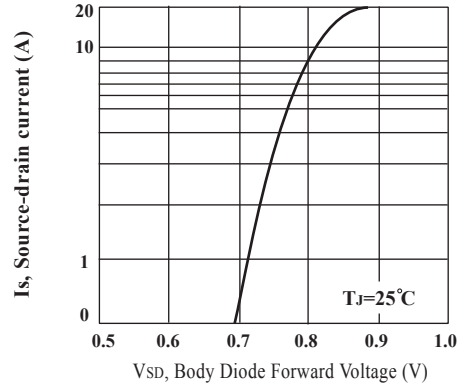

Fig.8 Body Diode Forward Voltage Variation with Source Current

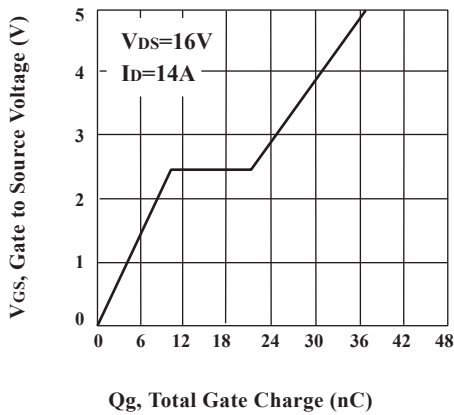

Fig.9 Gate Charge

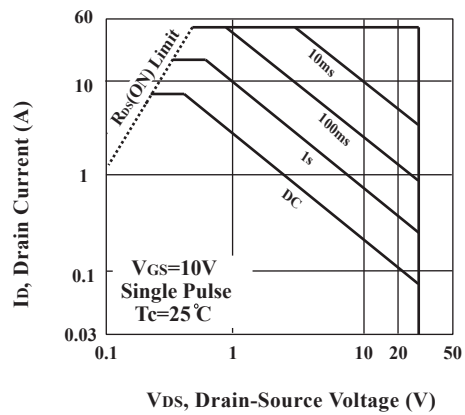

Fig.10 Maximum Safe Operating Area

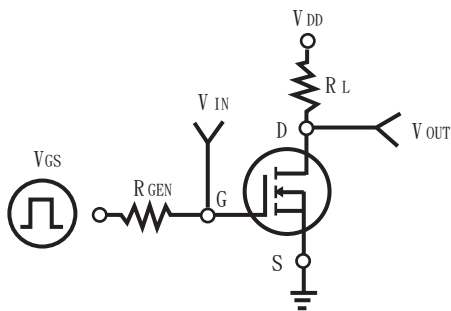

FIG.11 Switching Test Circuit

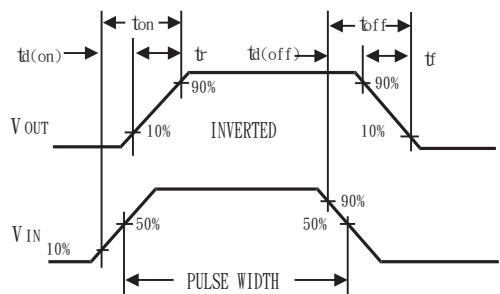

FIG.12 Switching Waveforms

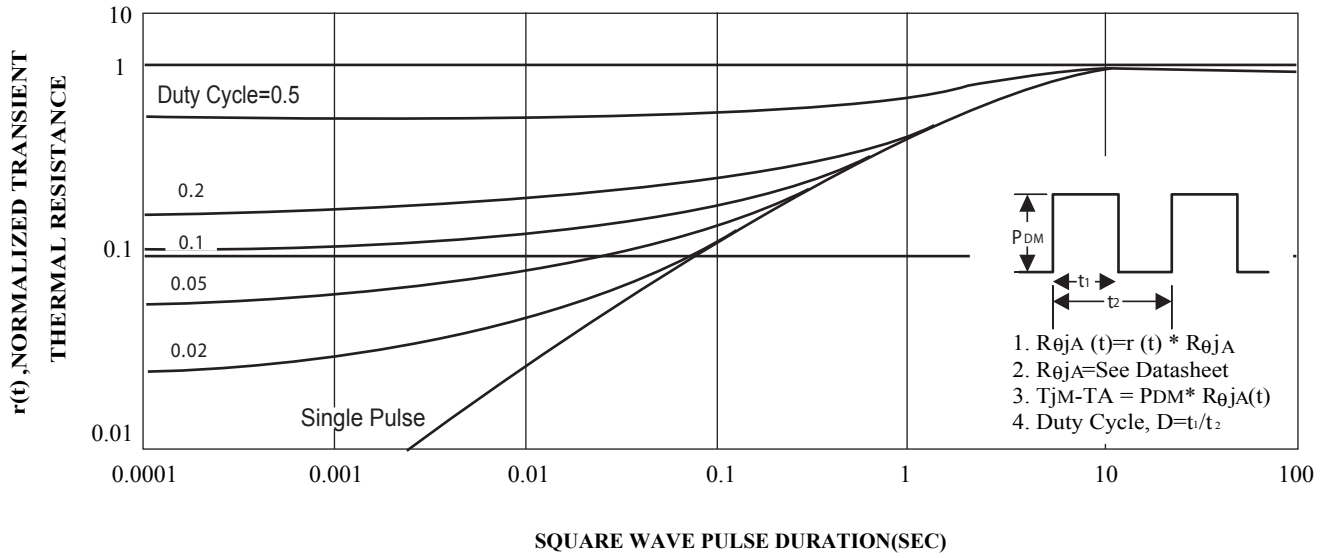
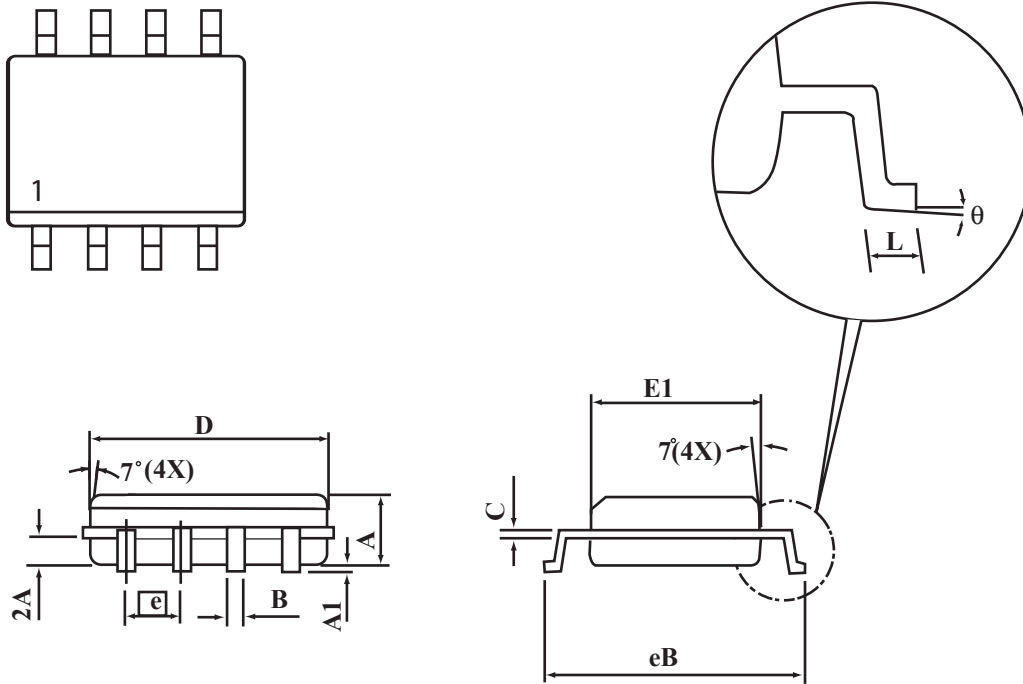

FIG.13 NORMALIZED THERMAL TRANSIENT IMPEDANCE CUREVE

SO-8 Package Outline Dimensions

Unit:mm



SYMBOLS	MILLIMETERS	
	MIN	MAX
A	1.35	1.75
A1	0.10	0.20
B	0.35	0.45
C	0.18	0.23
D	4.69	4.98
E1	3.56	4.06
eB	5.70	6.30
e	1.27 BSC	
L	0.60	0.80
θ	0°	8°