

ELECTRICAL SPECIFICATIONS:

- 1.0 TURNS RATIO: (P3-P2) : (J4-J5) : 1 : 1 ±2%
 (P5-P4) : (J6-J3) : 1 : 1 ±2%
 (P9-P8) : (J8-J7) : 1 : 1 ±2%
 (P10-P11) : (J2-J1) : 1 : 1 ±2%
- 2.0 INDUCTANCE: (P3-P2) ; (P5-P4) : 350 uH MIN. @ 0.1V, 100KHz, 8 mA DC BIAS
 (P10-P11) ; (P9-P8) : 350 uH MIN. @ 0.1V, 100KHz, 8 mA DC BIAS
- 3.0 LEAKAGE INDUCTANCE: P3-P2 (WITH J4 AND J5 SHORT) : 0.3uH MAX. @ 1MHz
 P5-P4 (WITH J6 AND J3 SHORT) : 0.3uH MAX. @ 1MHz
 P9-P8 (WITH J8 AND J7 SHORT) : 0.3uH MAX. @ 1MHz
 P10-P11 (WITH J1 AND J2 SHORT) : 0.3uH MAX. @ 1MHz
- 4.0 INTERWINDING CAPACITANCE: (P3-P2) : (J4-J5) : 35pf MAX @ 1MHz
 (P5-P4) : (J6-J3) : 35pf MAX @ 1MHz
 (P9-P8) : (J5-J4) : 35pf MAX @ 1MHz
 (P10-P11) : (J2-J1) : 35pf MAX @ 1MHz
- 5.0 DC RESISTANCE: (J6-J3) ; (J2-J1) ; (J7-J8) : (J4-J5) : 1.2 ohms Max.



Bel Stewart Connector
 11118 Susquehanna Trail, South
 Glen Rock, Pa 17327-9199
 717.234.7512



<http://www.stewartconnector.com>

THIS DRAWING AND THE SUBJECT MATTER SHOWN THEREON ARE CONFIDENTIAL AND PROPERTY OF BEL STEWART CONNECTOR AND SHALL NOT BE REPRODUCED, COPIED, OR USED IN ANY MANNER WITHOUT PRIOR WRITTEN CONTENT OF BEL STEWART CONNECTOR. THE SUBJECT MATTER MAY BE PATENTED OR A PATENT MAY BE PENDING.

SHEET
1 OF 4

DRAWING NO.
SI-51012-F

REV.
14

- 6.0 RETURN LOSS: 1MHz TO 30MHz : -19dB MIN.
30MHz TO 60MHz : -13dB MIN.
60MHz TO 80MHz : -12dB MIN.
80MHz TO 100MHz : -10dB MIN.
- 7.0 DIELECTRIC WITHSTAND: (J1,J2) TO (P10,P11) ; (J5,J4) TO (P3-P2) : 1500 VAC
(J3,J6) TO (P5,P4) ; (J8,J7) TO (P9, P8) : 1500 VAC
- 8.0 INSERTION LOSS: RS=RL=100 ohms : -1.1 dB TYP
100KHz TO 125MHz
- 9.0 RISE TIME: RS=100 OHMS AND RL = 100 OHMS : 3.0 nS MAX
OUTPUT VOLTAGE = 1 V peak : 3.0 nS MAX
PULSE WIDTH= 112nS
- 10.0 CROSS TALK: 1-100 MHz : $-[33-20 \text{ LOG } (\frac{F}{50 \text{ MHz}})] \text{ MIN.}$
- 11.0 COMMON TO COMMON MODE ATTENUATION: 1MHz TO 100MHz : -35dB TYP

Bel Stewart Connector
11118 Susquehanna Trail, South
Glen Rock, Pa 17327-9199
717.234.7512

MagJack®

<http://www.stewartconnector.com>

THIS DRAWING AND THE SUBJECT MATTER SHOWN THEREON ARE CONFIDENTIAL AND PROPERTY OF BEL STEWART CONNECTOR AND SHALL NOT BE REPRODUCED, COPIED, OR USED IN ANY MANNER WITHOUT PRIOR WRITTEN CONTENT OF BEL STEWART CONNECTOR. THE SUBJECT MATTER MAY BE PATENTED OR A PATENT MAY BE PENDING.

SHEET
2 OF 4

DRAWING NO.
SI-51012-F

REV.
14

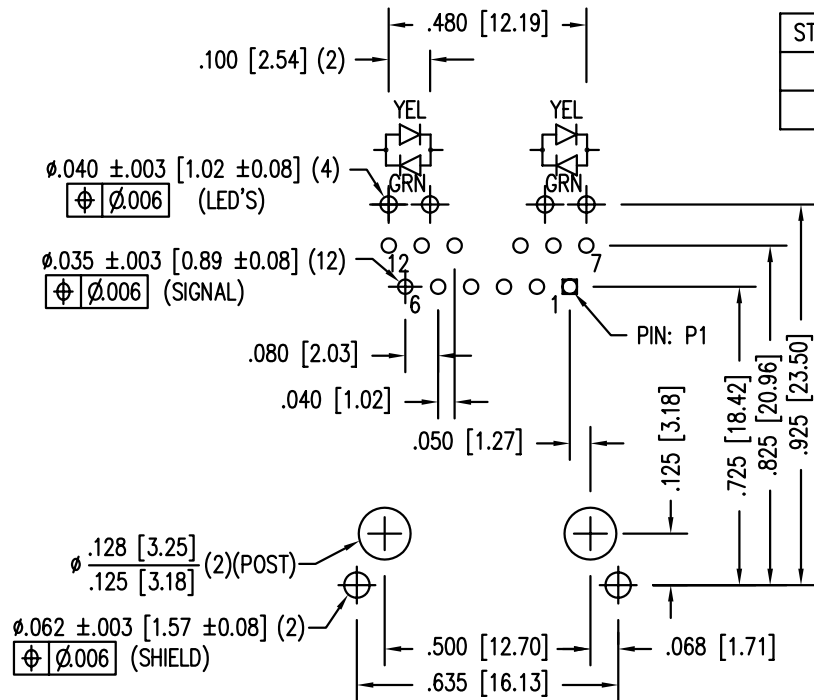
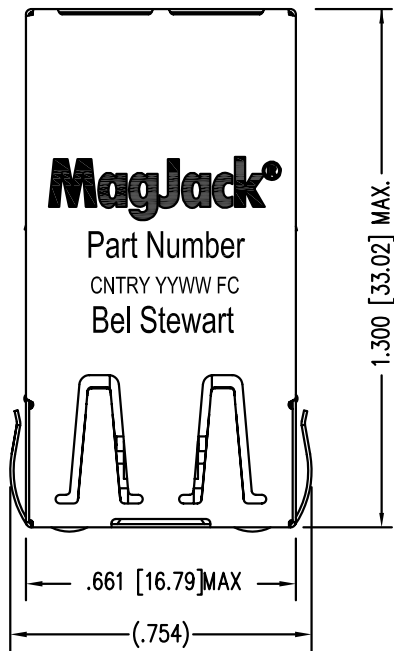

STANDARD LED	WAVELENGTH	FORWARD V (MAX)	* (TYP)
YELLOW	590 nm	2.5 V	2.1 V
GREEN	565 nm	2.5 V	2.2 V

* WITH A FORWARD CURRENT OF 20 mA (TYP)

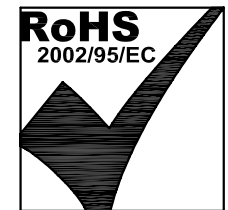

P.C.B. RECOMMENDED HOLE LAYOUT
SEEN FROM COMPONENT SIDE

ALL CENTERLINE DIMENSIONS ARE BASIC.

NOTES:

- CONNECTOR MATERIALS:
HOUSING: THERMOPLASTIC UL94 V-0
CONTACT/SHIELD: COPPER ALLOY
SHIELD PLATING: NICKEL OR TIN
CONTACT PLATING: SELECTIVE GOLD,
50 MICRO-INCHES MIN. IN CONTACT AREA.
- PIN NOT ELECTRICALLY CONNECTED MAYBE OMITTED.
SEE ELECTRICAL DRAWING FOR OMITTED PINS.
- TOLERANCES COMPLY WITH F.C.C. DIMENSION REQUIREMENTS.
- ALL TOLERANCES NOT OTHERWISE SPECIFIED TO BE ±.005 [0.13]
- REFLOW AND WAVE SOLDER COMPATIBLE -260°C FOR 10 SECONDS MAX.

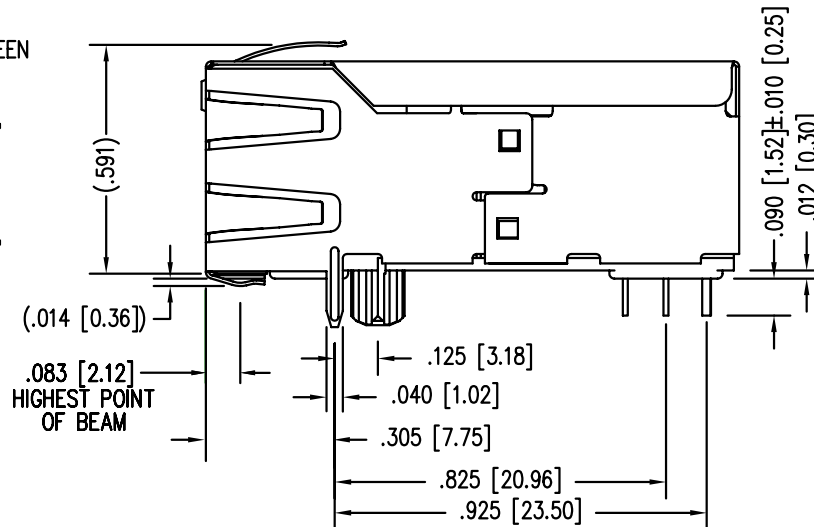
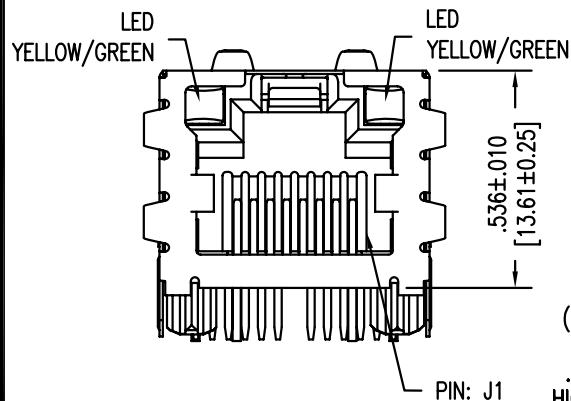

Bel Stewart Connector
11118 Susquehanna Trail, South
Glen Rock, Pa 17327-9199
717.234.7512

MagJack

<http://www.stewartconnector.com>

THIS DRAWING AND THE SUBJECT MATTER SHOWN THEREON ARE CONFIDENTIAL AND PROPERTY OF BEL STEWART CONNECTOR AND SHALL NOT BE REPRODUCED, COPIED, OR USED IN ANY MANNER WITHOUT PRIOR WRITTEN CONTENT OF BEL STEWART CONNECTOR. THE SUBJECT MATTER MAY BE PATENTED OR A PATENT MAY BE PENDING.

SHEET 3 OF 4

DRAWING NO. SI-51012-F

REV. 01

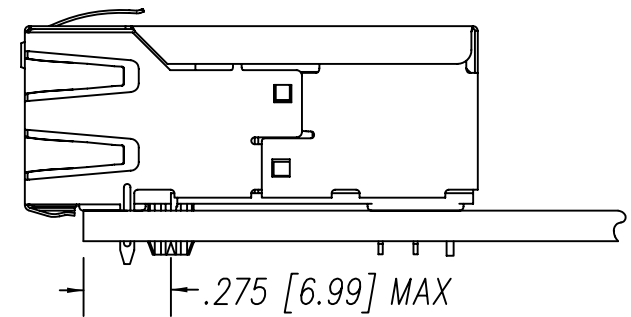
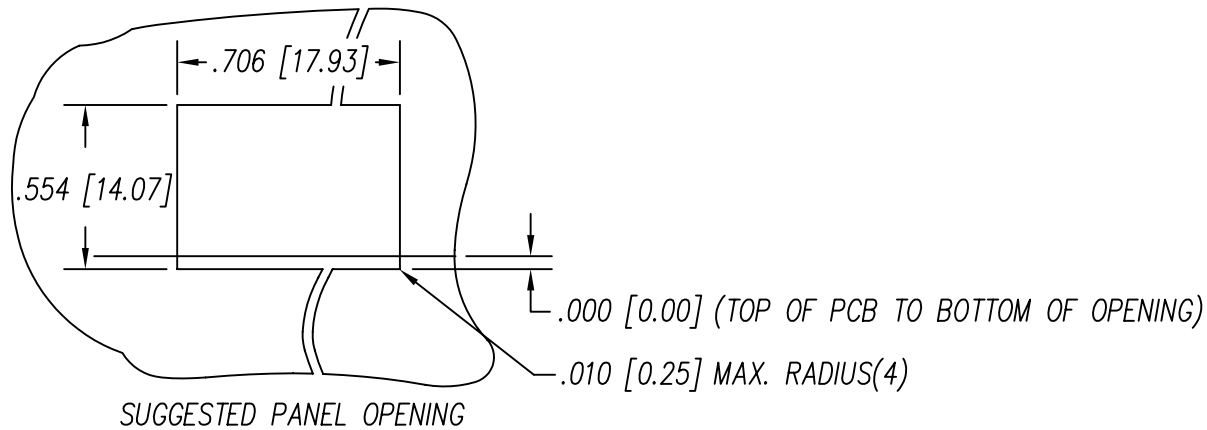

1. THE SUGGESTED PANEL OPENING IS INTENDED TO GIVE THE USER THE ABILITY TO HAVE REASONABLE JACK / PANEL CLEARANCES YET MAINTAIN RELIABLE GROUNDING CAPABILITY.
2. ALL TOLERANCES NOT OTHERWISE SPECIFIED TO BE ± 0.005 [0.13]

Bel Stewart Connector
 11118 Susquehanna Trail, South
 Glen Rock, Pa 17327-9199
 717.234.7512

MagJack®

<http://www.stewartconnector.com>

THIS DRAWING AND THE SUBJECT MATTER SHOWN THEREON ARE CONFIDENTIAL AND PROPERTY OF BEL STEWART CONNECTOR AND SHALL NOT BE REPRODUCED, COPIED, OR USED IN ANY MANNER WITHOUT PRIOR WRITTEN CONTENT OF BEL STEWART CONNECTOR. THE SUBJECT MATTER MAY BE PATENTED OR A PATENT MAY BE PENDING.

SHEET
4 OF 4

DRAWING NO.
SI-51012-F

REV.
01