

# SHINDENGEN

## Schottky Rectifiers (SBD)

Dual

# SF30SC4

## 40V 30A

### FEATURES

- Tj150
- P<sub>RRSM</sub> avalanche guaranteed
- Fully Isolated Molding
- High capacity with Small Package
- Dielectric strength 2kV guaranteed

### APPLICATION

- Switching power supply
- DC/DC converter
- Home Appliances, Office Equipment
- Telecommunication

### OUTLINE DIMENSIONS

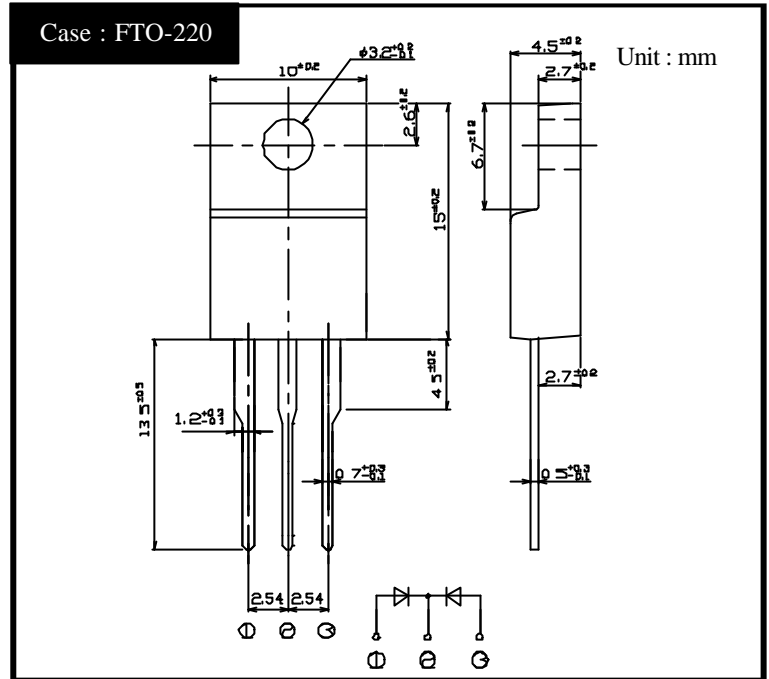

### RATINGS

Absolute Maximum Ratings (If not specified Tc=25 )

Item	Symbol	Conditions	Ratings	Unit
Storage Temperature	T <sub>stg</sub>		-55 ~ 150	
Operating Junction Temperature	T <sub>j</sub>		150	
Maximum Reverse Voltage	V <sub>RM</sub>		40	V
Repetitive Peak Surge Reverse Voltage	V <sub>RRSM</sub>	Pulse width 0.5ms, duty 1/40	45	V
Average Rectified Forward Current	I <sub>O</sub>	50Hz sine wave, R-load, Rating for each diode I <sub>O</sub> /2, Tc=102	30	A
Peak Surge Forward Current	I <sub>FSM</sub>	50Hz sine wave, Non-repetitive 1 cycle peak value, Tj=25	300	A
Repetitive Peak Surge Reverse Power	P <sub>RRSM</sub>	Pulse width 10 μs, Rating of per diode, Tj=25	1000	W
Dielectric Strength	V <sub>dis</sub>	Terminals to case, AC 1 minute	2	kV
Mounting Torque	TOR	(Recommended torque :0.3N·m)	0.5	N·m

Electrical Characteristics (If not specified Tc=25 )

Item	Symbol	Conditions	Ratings	Unit
Forward Voltage	V <sub>F</sub>	I <sub>F</sub> =15A, Pulse measurement, Rating of per diode	Max.0.55	V
Reverse Current	I <sub>R</sub>	V <sub>R</sub> =V <sub>RM</sub> , Pulse measurement, Rating of per diode	Max.10	mA
Junction Capacitance	C <sub>j</sub>	f=1MHz, V <sub>R</sub> =10V, Rating of per diode	Typ.590	pF
Thermal Resistance	θ <sub>jc</sub>	junction to case	Max.2.0	/W

# SF30SC4

## Forward Voltage

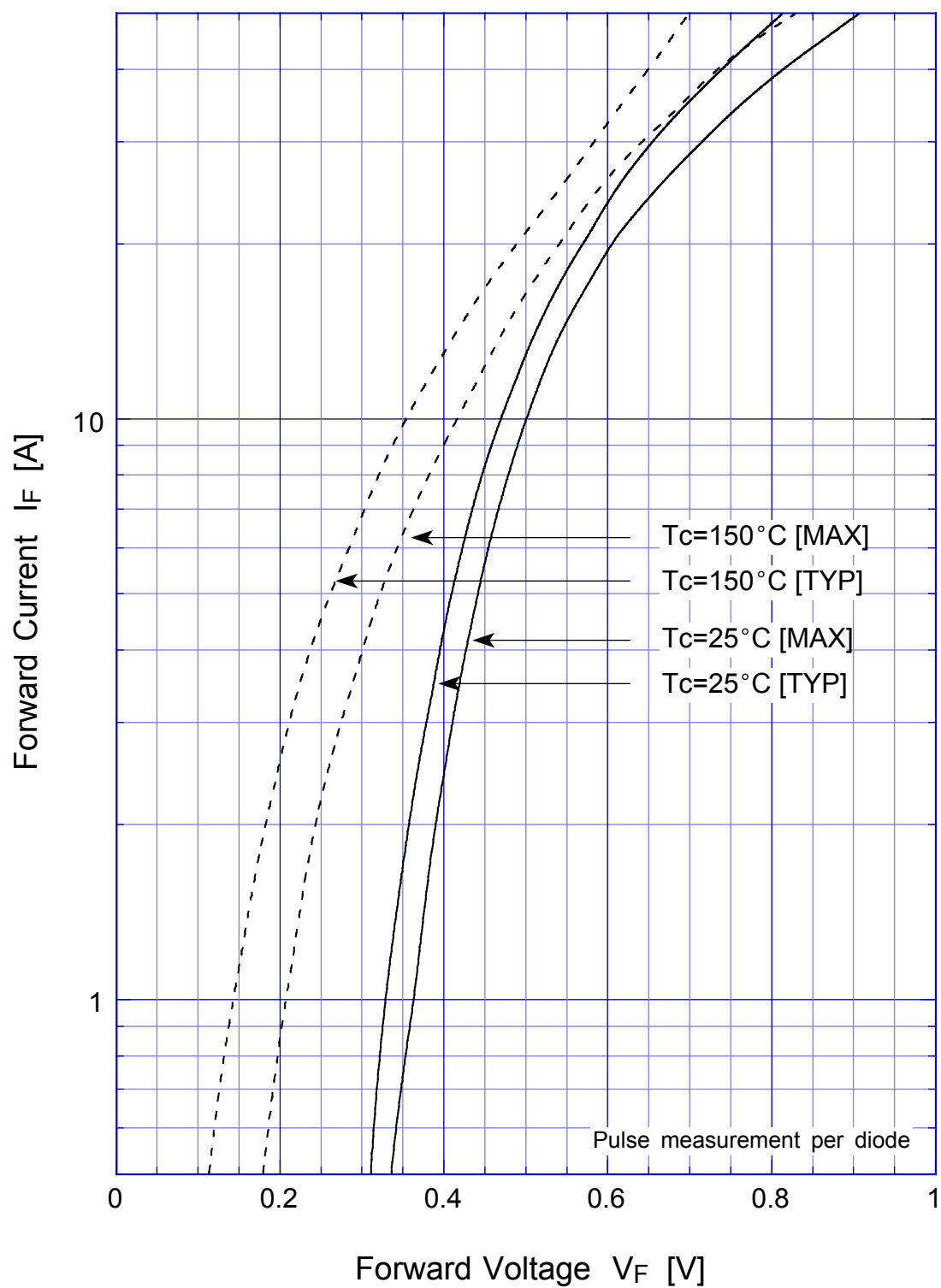

# SF30SC4 Junction Capacitance

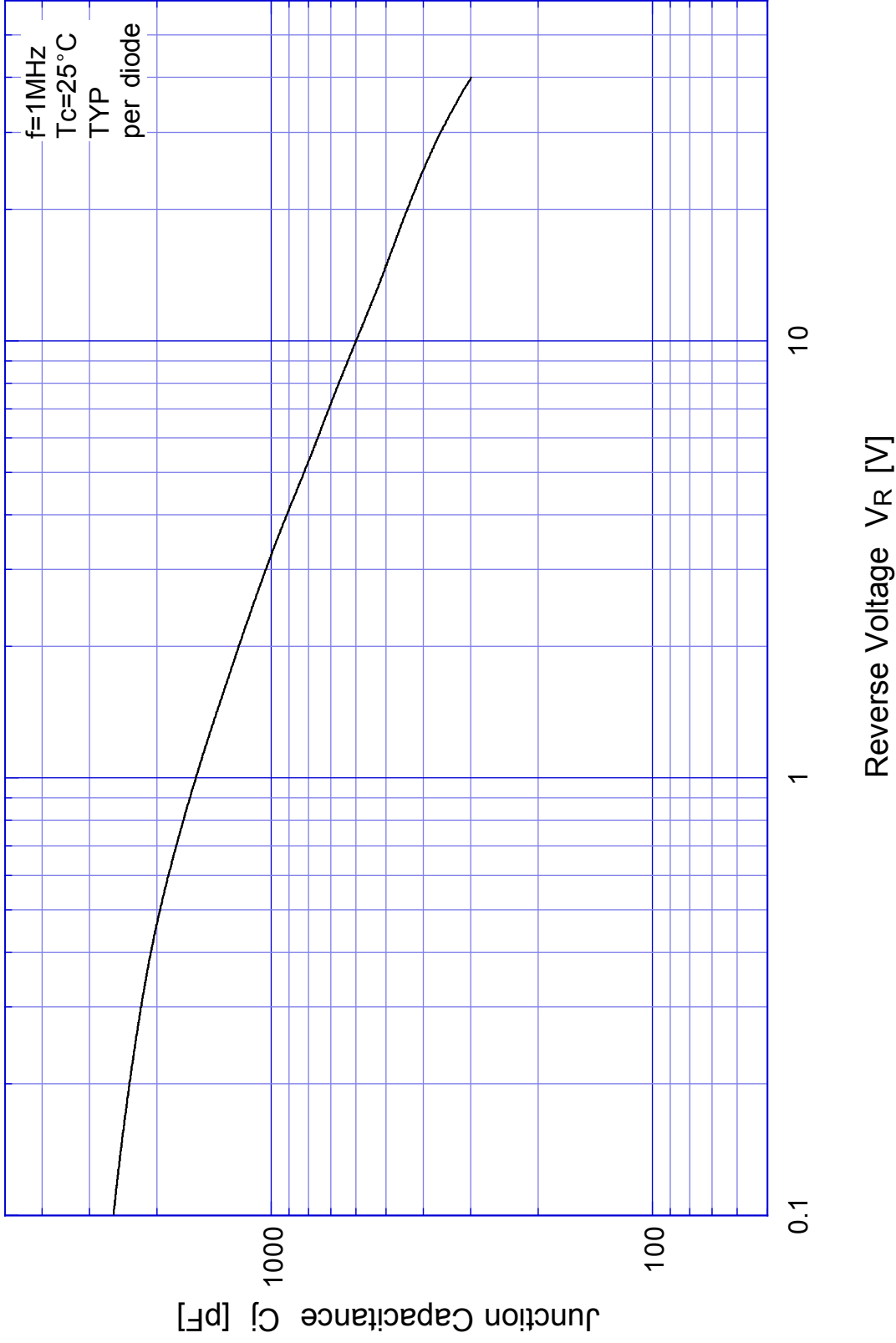

# SF30SC4

## Reverse Current

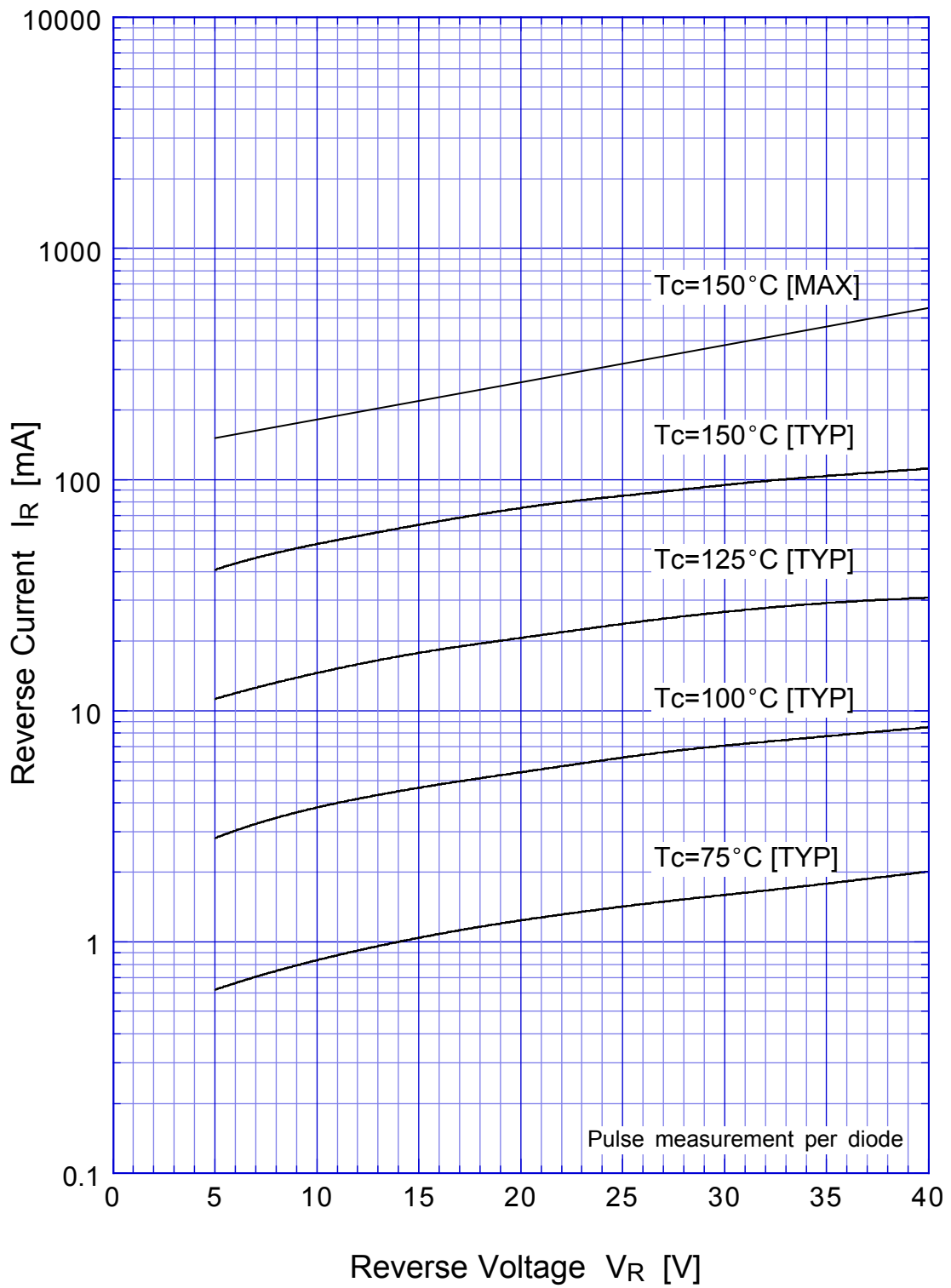

# SF30SC4 Reverse Power Dissipation

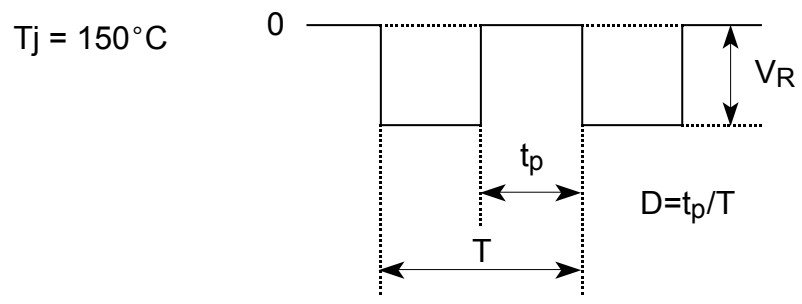
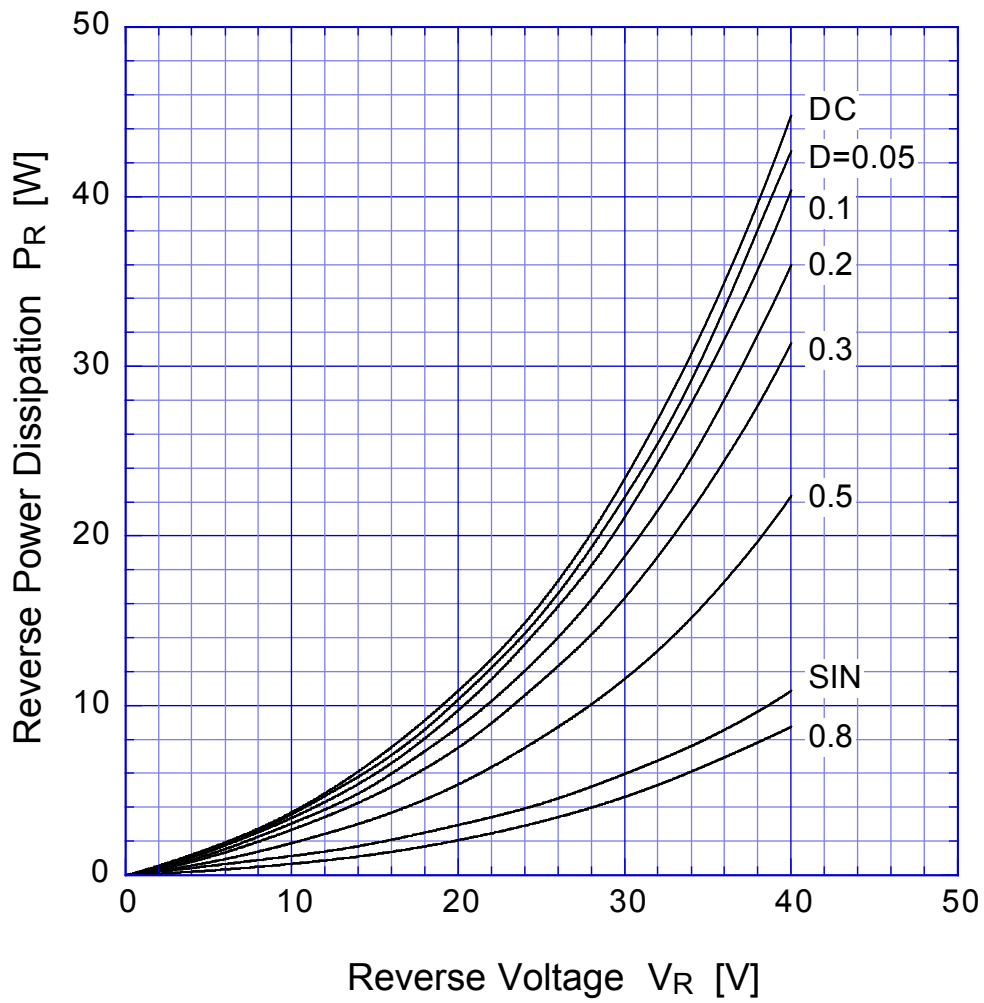

# SF30SC4 Forward Power Dissipation

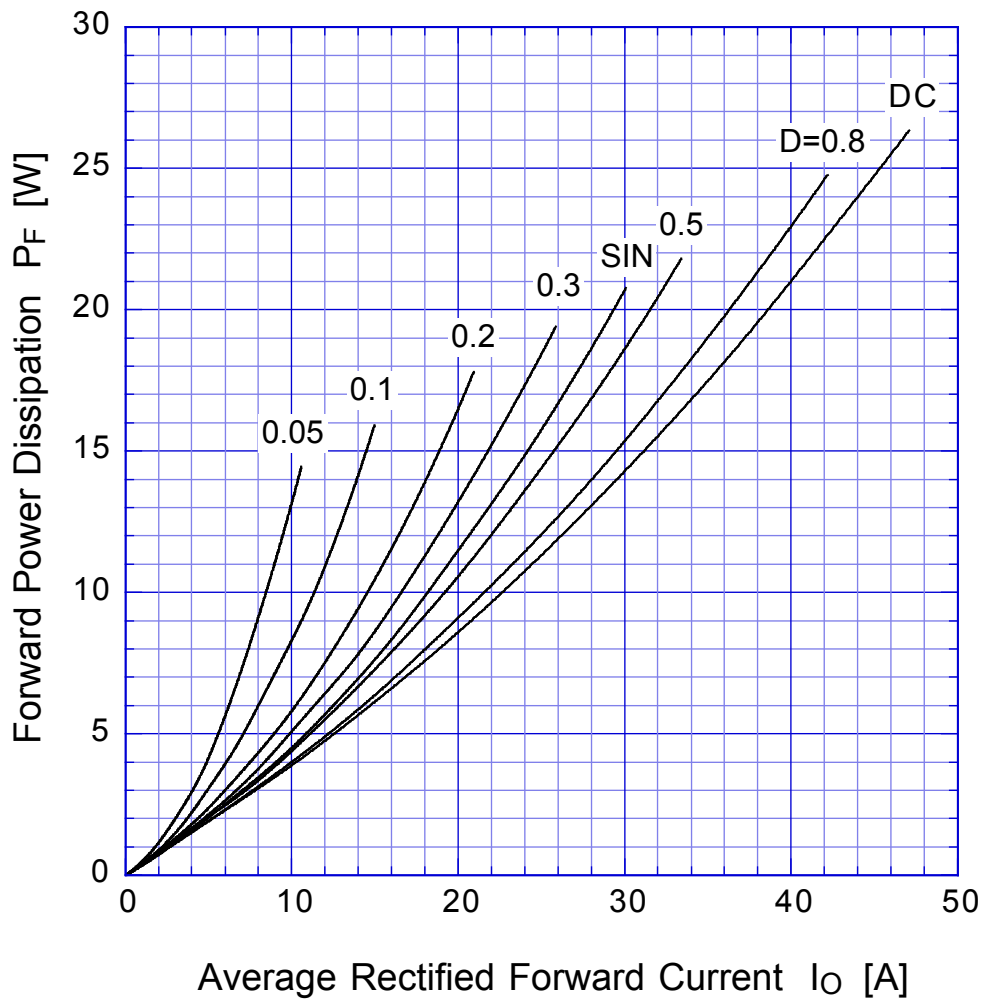

$T_j = 150^\circ\text{C}$

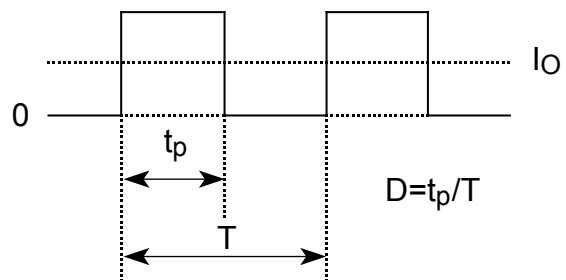

# SF30SC4

# Derating Curve

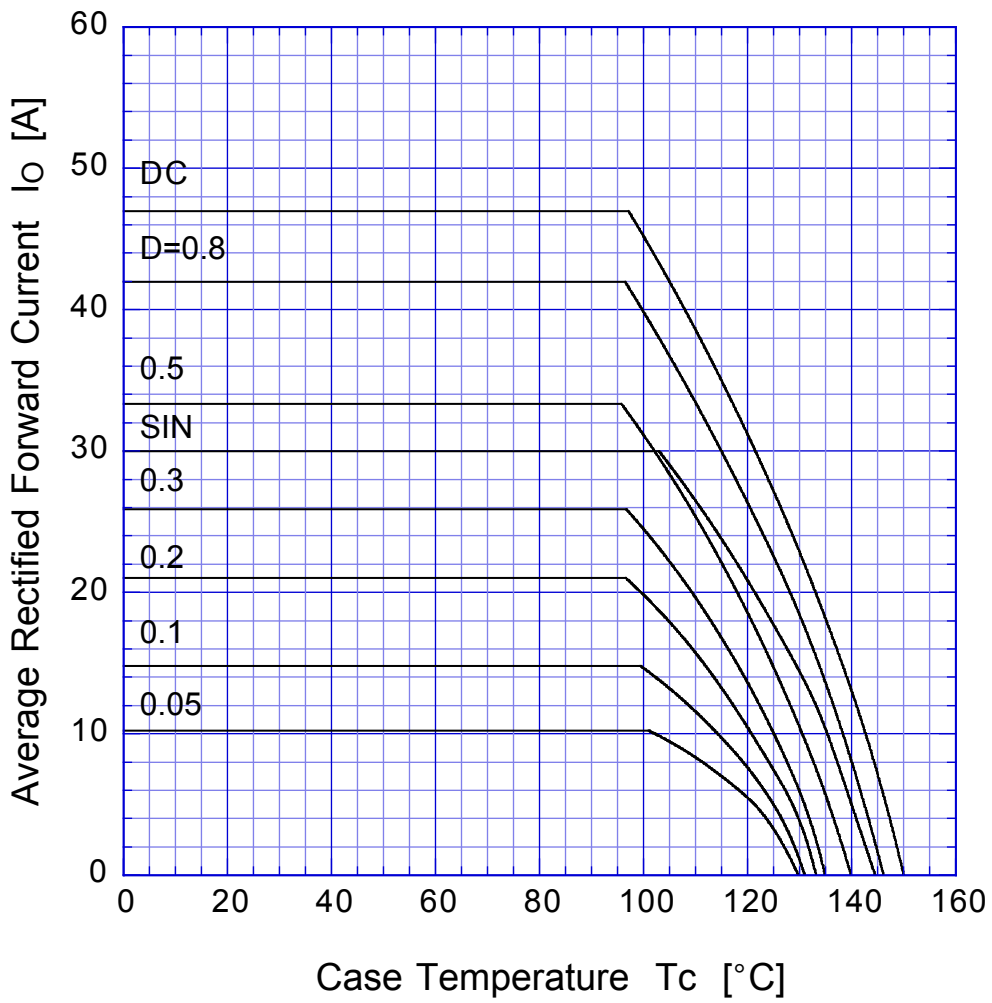

$V_R = 20V$



# SF30SC4 Peak Surge Forward Capability

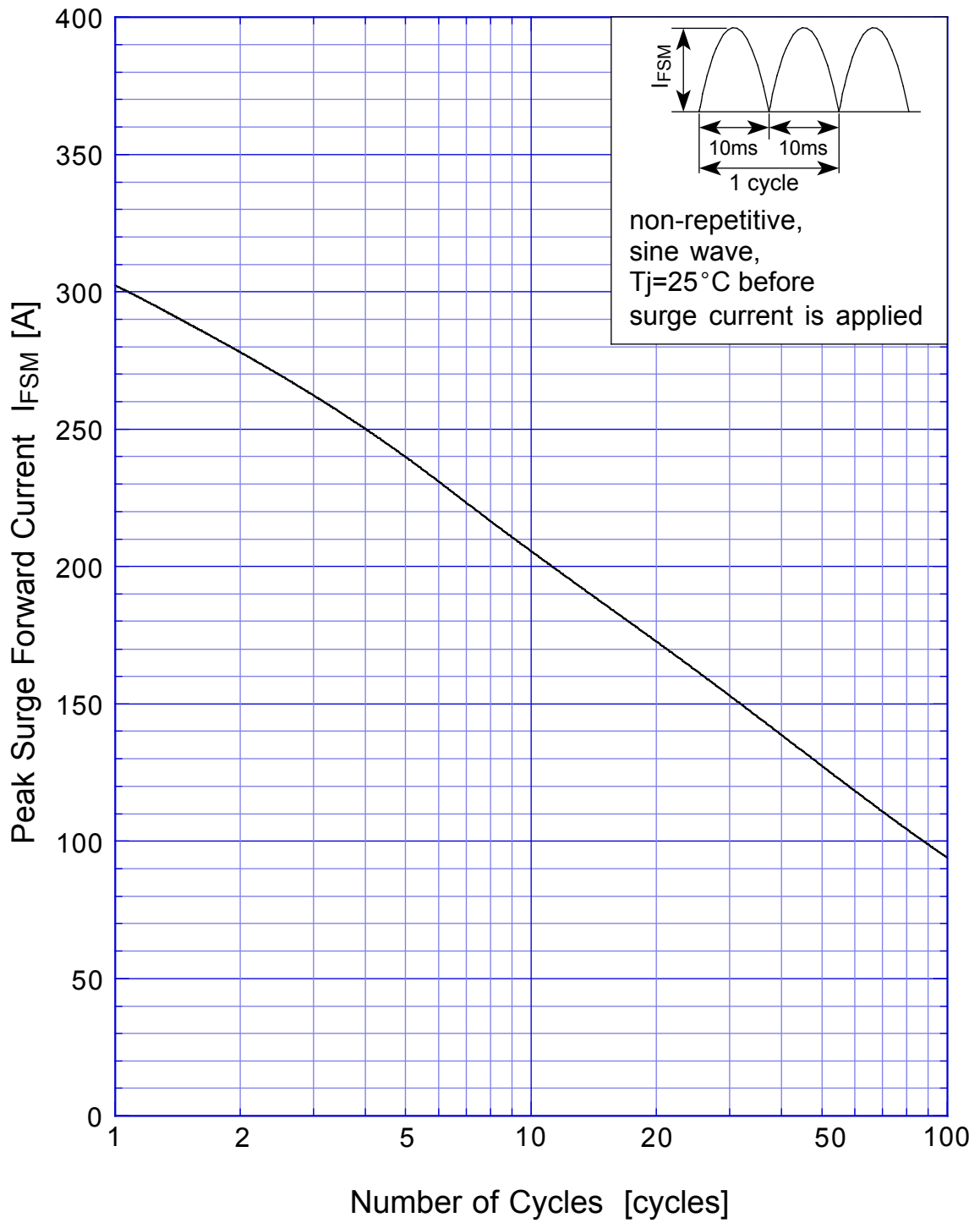



# SBD Repetitive Surge Reverse Power Derating Curve

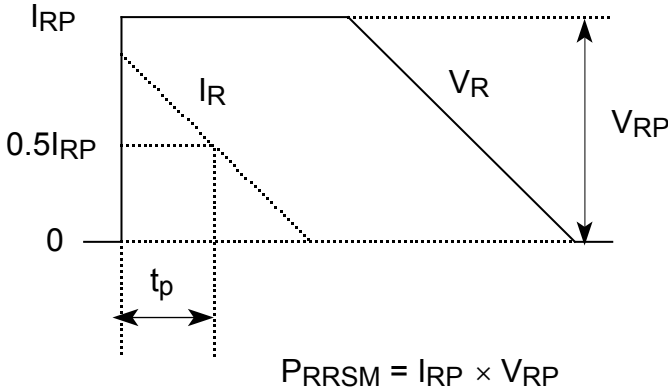
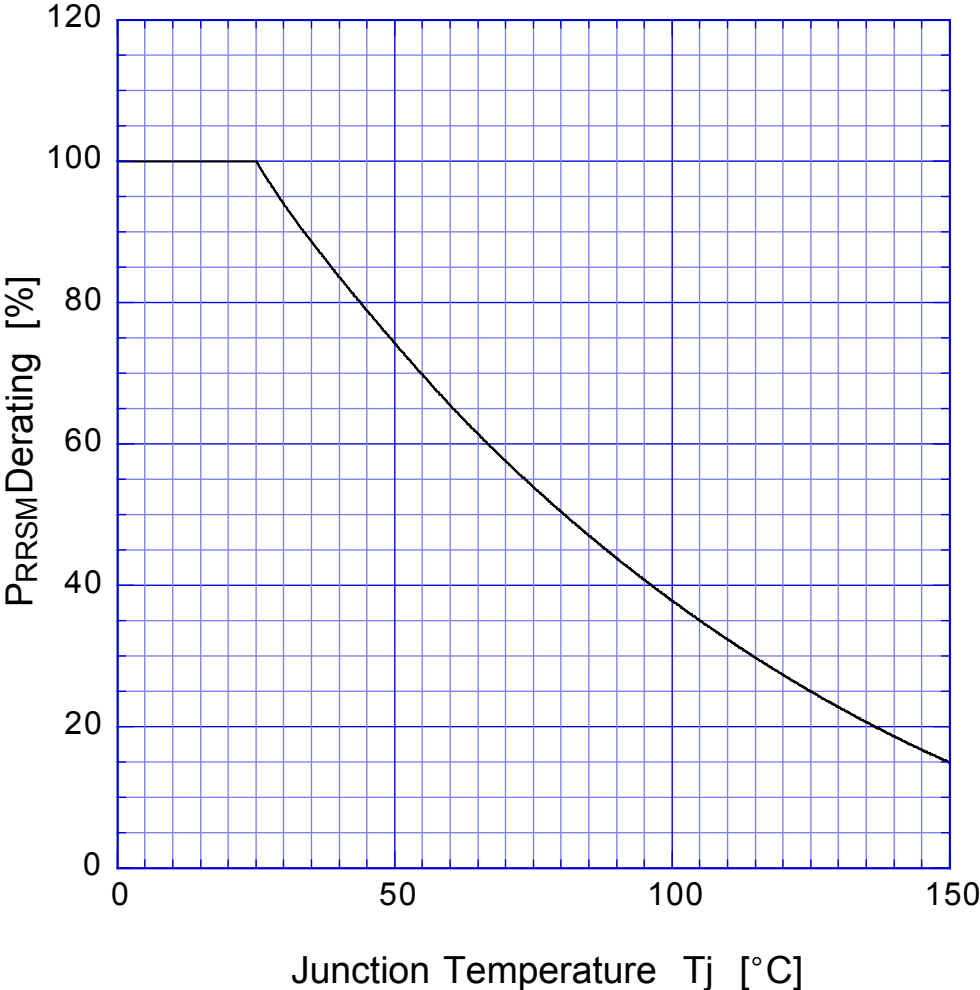

# SBD

## Repetitive Surge Reverse Power Capability

