

NEC[®]**NPN MEDIUM POWER
UHF-VHF TRANSISTOR****NE22100
NE22120****FEATURES**

- ULTRA-LINEAR BROAD-BAND AMPLIFIER
- LOW DISTORTION AT HIGH POWER

DESCRIPTION AND APPLICATIONS

The NE221 is an NPN silicon, bipolar transistor series, designed especially for wide-band, low distortion amplifiers at UHF. The series has excellent power capabilities for oscillators (up to 1 GHz) and, CATV and MATV linear amplifiers. The NE22120 features NEC's high-reliability platinum/silicide, titanium, platinum, and gold metallized chips in the molded stripline 20 package. This combination yields excellent economy and performance with the utmost in reliability and ruggedness.

ABSOLUTE MAXIMUM RATINGS (T_A = 25°C)

SYMBOLS	PARAMETERS	UNITS	RATINGS
V _{CB0}	Collector to Base Voltage	V	35
V _{CE0}	Collector to Emitter Voltage	V	18*
V _{EB0}	Emitter to Base Voltage	V	3
I _c	Collector Current	mA	250
T _J	Junction Temperature	°C	200
T _{STG}	Storage Temperature	°C	-65 to +200

*Typical V_{CE0} = 35 V for R ≤ 300 Ω**PERFORMANCE SPECIFICATIONS** (T_A = 25°C)

PART NUMBER EIAJ ¹ REGISTERED NUMBER PACKAGE OUTLINE		NE22120 2SC2065 20			
SYMBOLS	PARAMETERS AND CONDITIONS	UNITS	MIN	TYP	MAX
f _r	Gain Bandwidth Product at V _{CE} = 10 V, I _c = 80 mA	GHz	2.8	3.2	
S _{21E} ²	Insertion Power Gain at V _{CE} = 10 V, I _c = 80 mA, f = 0.5 GHz f = 1 GHz	dB dB		11 5.5	
MAG	Maximum Available Gain ² at V _{CE} = 10 V, I _c = 80 mA, f = 0.5 GHz f = 1 GHz	dB dB	13.5	14.5 9	
IM ₂₊	Second Order Intermodulation Product at V _{CE} = 10 V, I _c = 80 mA, V _o = 110 dBμV/75 Ω, f ₁ = 90 MHz, f ₂ = 90 MHz, f = f ₁ + f ₂	dB		-59	
IM ₂₋	Second Order Intermodulation Product at V _{CE} = 10 V, I _c = 80 mA, V _o = 110 dBμV/75 Ω, f ₁ = 190 MHz, f ₂ = 90 MHz, f = f ₁ - f ₂	dB		-63	
IM ₃	Third Order Intermodulation Product at V _{CE} = 10 V, I _c = 80 mA, V _o = 110 dBμV/75 Ω, f ₁ = 190 MHz, f ₂ = 200 MHz, f = 2f ₁ - f ₂	dB	-75	-78	

Notes:

1. Electronic Industrial Association of Japan.

$$2. \text{MAG} = |S_{21E}|^2 \cdot \frac{1}{1 - |S_{11E}|^2} \cdot \frac{1}{1 - |S_{22E}|^2}$$

OUTLINE DIMENSIONS (Units in mm)

NE22100 (CHIP)
(Chip Thickness: 160 μm ± 20 μm)

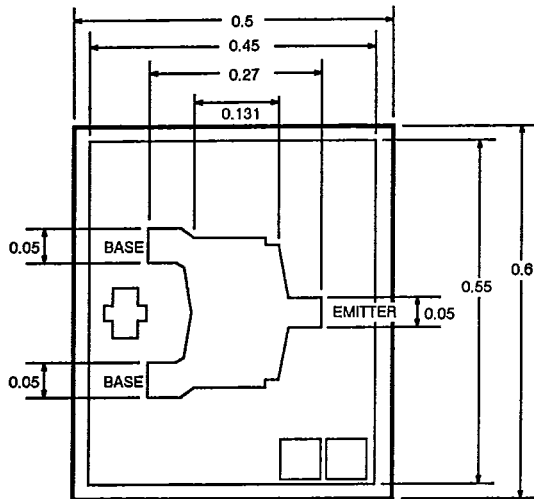

OUTLINE 20

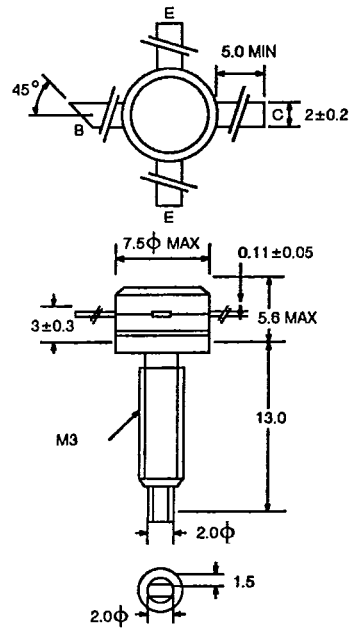

ELECTRICAL CHARACTERISTICS (TA = 25°C)

PART NUMBER EIAJ ¹ REGISTERED NUMBER PACKAGE OUTLINE			NE22120 2SC2065 20		
SYMBOLS	PARAMETERS AND CONDITIONS	UNITS	MIN	TYP	MAX
Icbo	Collector Cutoff Current at Vcb = 20 V, Ie = 0	μA			10
Iebo	Emitter Cutoff Current at Veb = 2 V, Ic = 0	μA			10
hFE	Forward Current Gain at Vce = 10 V, Ic = 80 mA (pulsed)		20	100	200
Ccb	Collector to Base Capacitance ² at Vcb = 10 V, Ie = 0, f = 1 MHz	pF		2	3
Rφjc	Thermal Resistance (Junction-to-Case)	°C/W			25
Pt	Total Power Dissipation (Tc = 25°)	W			7

Notes:

1. Electronic Industrial Association of Japan.
2. Ccb measurement employs a three terminal capacitance bridge incorporating a guard circuit. The emitter shall be connected to the guard terminal.

TYPICAL THERMAL AND CAPACITANCE CHARACTERISTICS

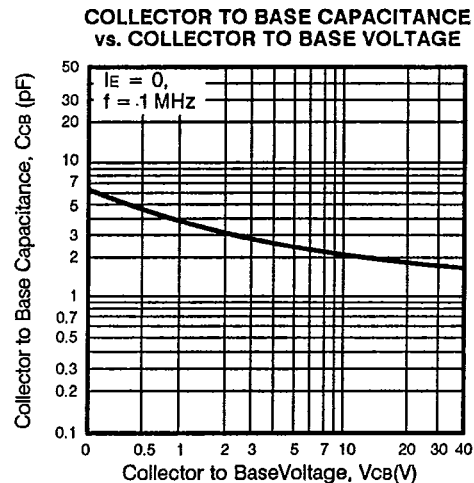
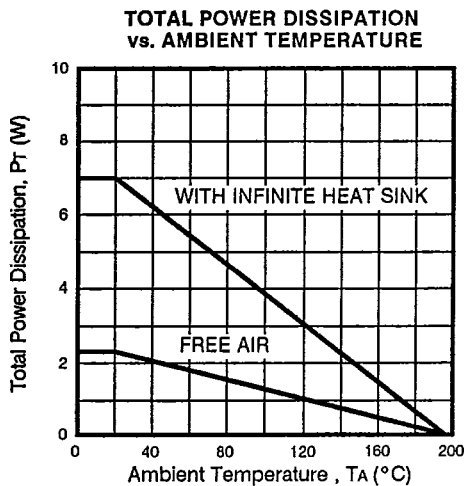

TYPICAL GAIN CHARACTERISTICS

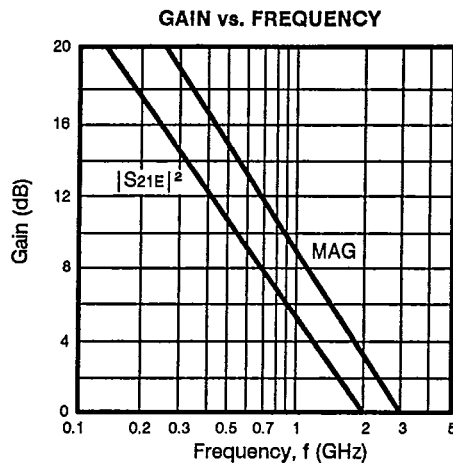

TYPICAL PERFORMANCE CHARACTERISTICS (TA=25°C)

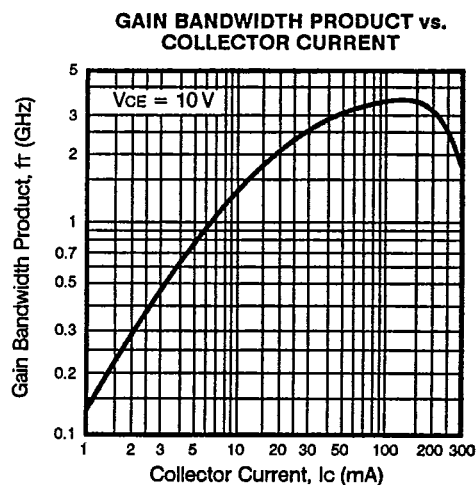
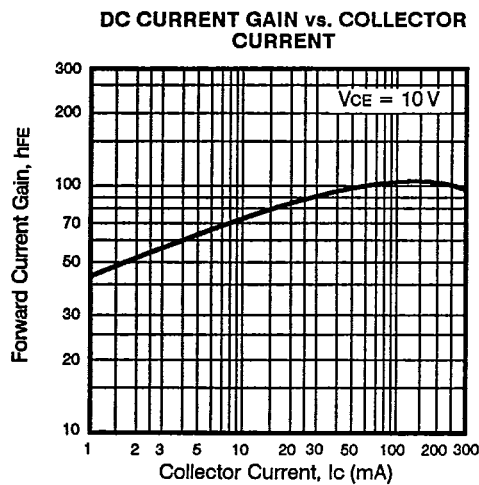

TYPICAL INTERMODULATION DISTORTION CHARACTERISTICS

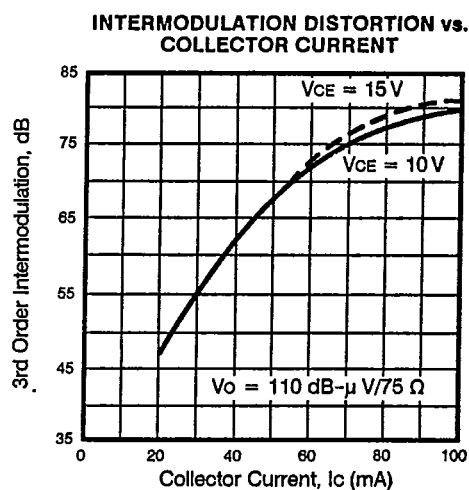
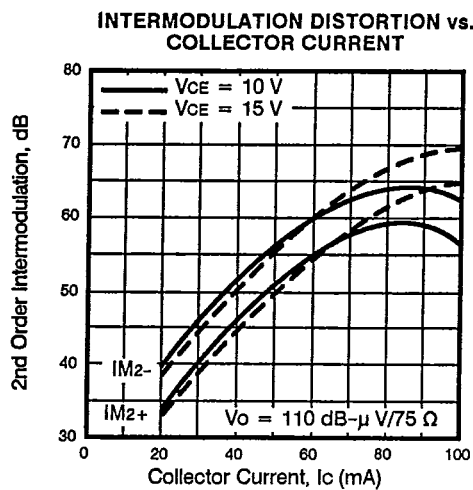

TYPICAL COMMON EMITTER SCATTERING PARAMETERS

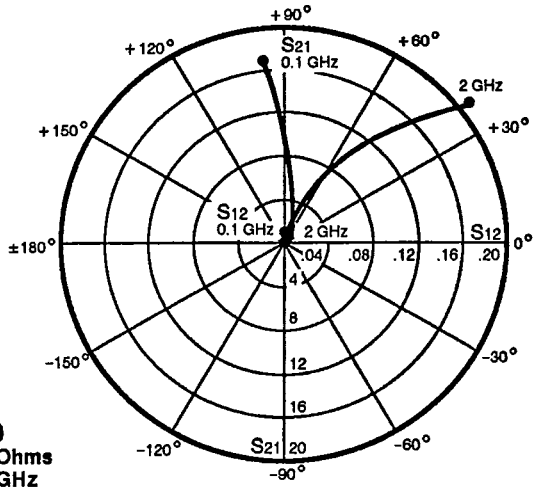
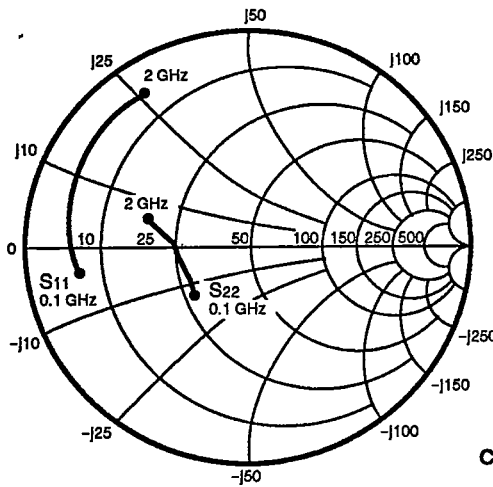

NE22120
Coordinates in Ohms
Frequency in GHz
(VCE = 10 V, IC = 100 mA)

S-MAGN AND ANGLES:

VCE = 10 V, IC = 50 mA

FREQUENCY (MHz)	S11		S21		S12		S22	
100	.77	-169	14.58	96	.01	44	.29	-112
500	.83	168	2.93	66	.05	57	.25	-158
1000	.83	152	1.46	40	.10	56	.34	-167
1500	.83	137	.97	19	.14	46	.43	-176
2000	.84	124	.74	5	.20	40	.52	172

VCE = 10 V, IC = 100 mA

100	.78	-172	16.22	94	.01	55	.34	-137
500	.82	167	3.21	67	.06	62	.33	-175
1000	.83	152	1.60	42	.10	56	.38	177
1500	.83	137	1.08	22	.15	46	.43	172
2000	.83	124	.83	7	.21	39	.49	163

VCE = 15 V, IC = 50 mA

100	.76	-167	15.39	97	.01	55	.27	-107
500	.81	168	3.10	66	.05	57	.23	-154
1000	.83	153	1.54	41	.10	54	.31	-164
1500	.83	138	1.03	19	.14	46	.41	-173
2000	.83	125	.78	4	.19	40	.50	175

VCE = 15 V, IC = 100 mA

100	.76	-170	16.99	95	.01	54	.31	-133
500	.81	168	3.35	67	.06	60	.29	-172
1000	.82	152	1.68	43	.10	56	.34	180
1500	.82	138	1.13	22	.15	45	.40	175
2000	.82	125	.87	7	.20	38	.47	167

