

# REFERENCE DESIGN IRDCiP2003A-C

International Rectifier • 233 Kansas Street, El Segundo, CA 90245 USA

## IRDCiP2003A-C: 1MHz, 160A, Synchronous Buck Converter Using iP2003A



### Overview

This reference design is capable of delivering up to a current of 160A with the enclosed heatsink attached at an ambient temperature of 60°C with 400LFM or an ambient temperature of 45°C with 200LFM of airflow. Performance graphs and waveforms are provided in figures 1–9. The figures and table in pages 5 – 8 are provided as a reference design to enable engineers to very quickly and easily design a 4-phase converter. Refer to the data sheet for the controller listed in the bill of materials in order to optimize this design to your specific requirements. A variety of other controllers may also be used, but the design will require layout and control circuit modifications.

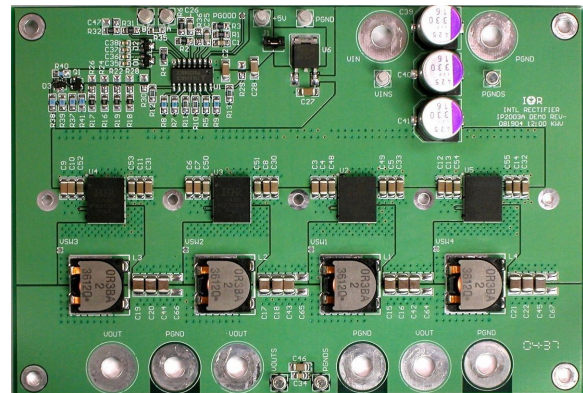

### Demoboard Quick Start Guide

#### Initial Settings:

The output is set to 1.3V, but can be adjusted from 0.8V to 3.3V by changing the voltage divider values of R3 and R32 according to the following formula:

$$R3 = R32 = (24.9k \times 0.8) / (VOUT - 0.8)$$

The switching frequency per phase is set to 1MHz with the frequency set resistor R4. This creates an effective output frequency of 4MHz. The graph in figure 11 shows the relationship between R4 and the switching frequency per phase. The frequency may be adjusted by changing R4 as indicated; however, extreme changes from the 1MHz set point may require redesigning the control loop and adjusting the values of input and output capacitors. Refer to the SOA graph in the iP2003A datasheet for maximum operating current at different conditions.

#### Procedure for Connecting and Powering Up Demoboard:

1. Apply input voltage across (+12V) across VIN and PGND.
2. Apply load across VOUT pads and PGND pads.
3. Adjust load to desired level. See recommendations below.

### IRDCiP2003A-C Recommended Operating Conditions

(refer to the iP2003A datasheet for maximum operating conditions)

Input voltage:	5V - 12V <sup>1</sup>
Output voltage:	0.8 - 3.3V
Switching Freq:	1MHz per phase, 4MHz effective output frequency.
Output current:	This reference design is capable of delivering up to 160A with the enclosed heatsink attached, at an ambient temperature of 60°C with 400LFM of airflow, or an ambient temperature of 45°C with 200LFM of airflow.

<sup>1</sup>Note: If Vin = 5V, then connect Vin to test point TP3 and Terminal T1 and remove jumper J1. Refer to schematic for details. Additionally, the threshold of the POR circuit should be adjusted to allow the supply to sequence properly.

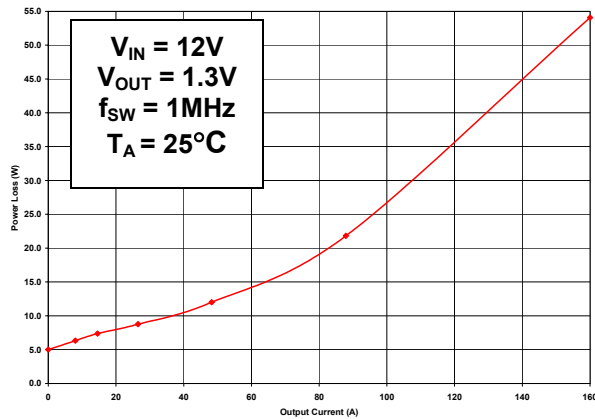

Fig. 1: Power Loss vs. Current

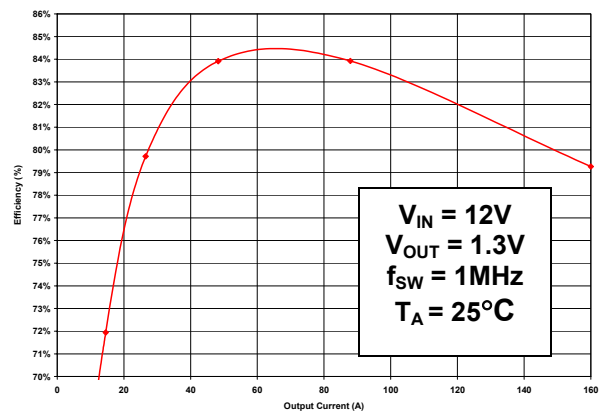

Fig. 2: Efficiency vs. Current

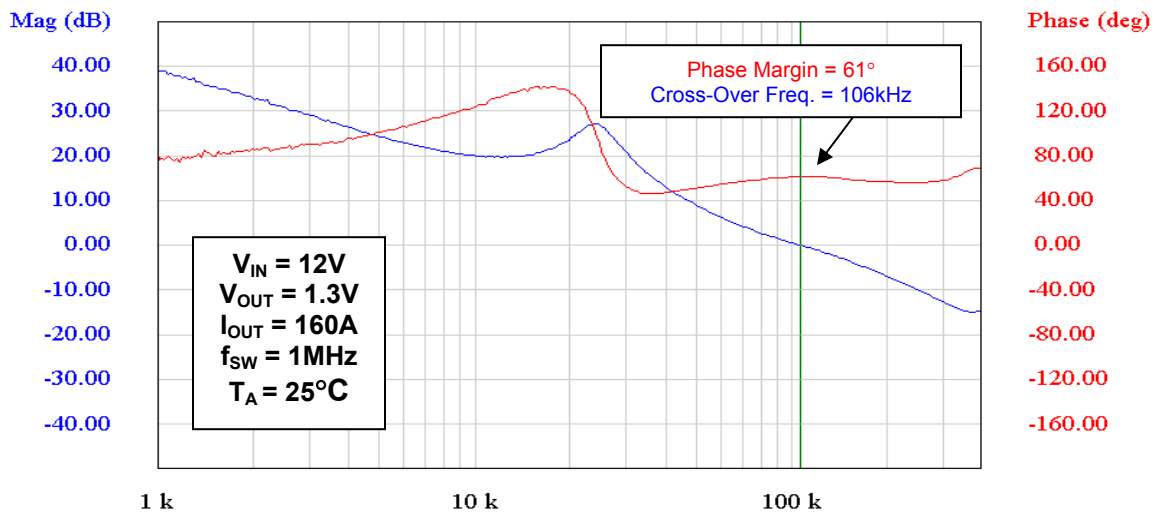

Fig. 3: Bode Plot

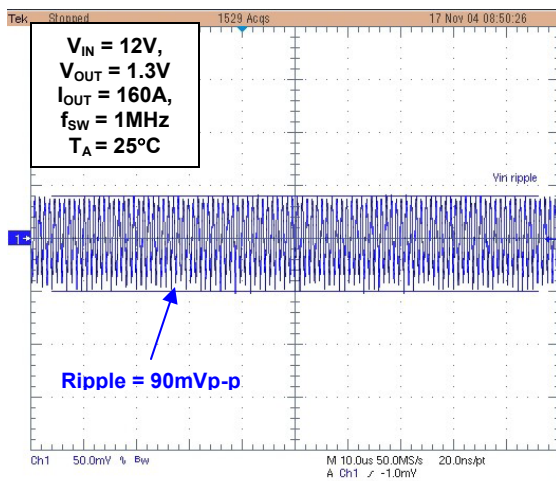

Fig. 4: Input Voltage Ripple Waveform

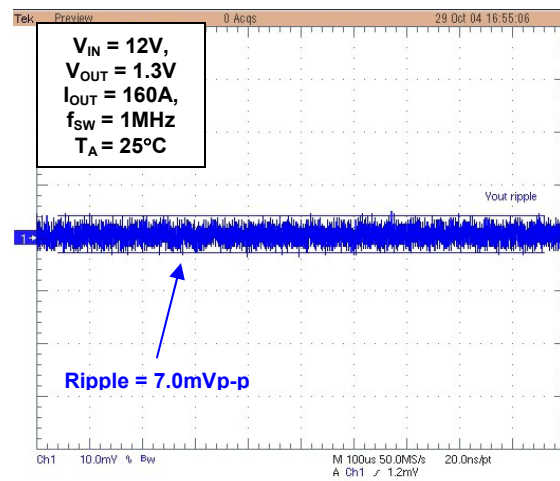

Fig. 5: Output Voltage Ripple Waveform

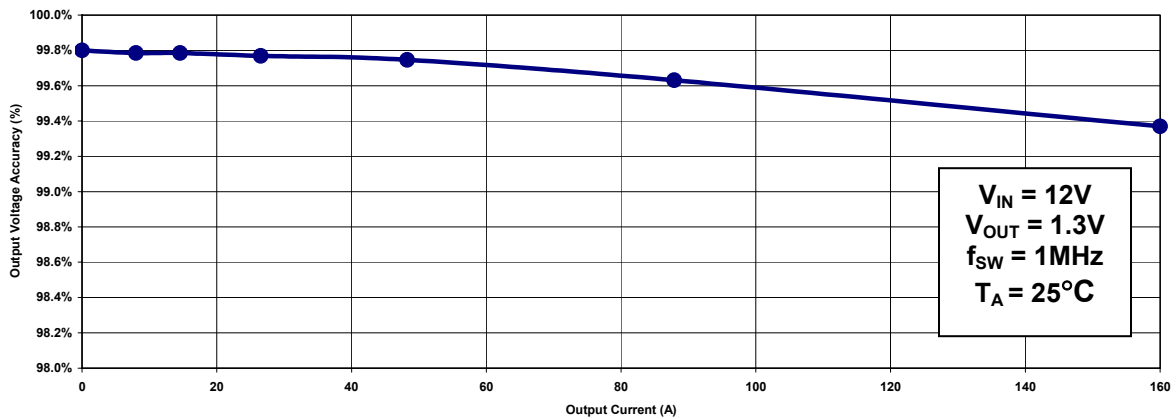

Fig. 6: Output Voltage Accuracy vs. Current

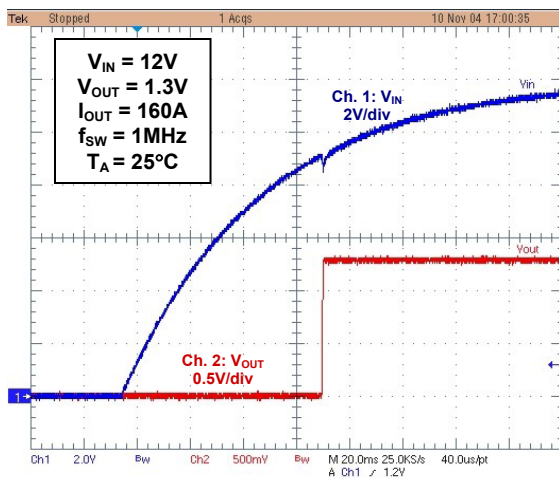

Fig. 7: Power Up Waveform

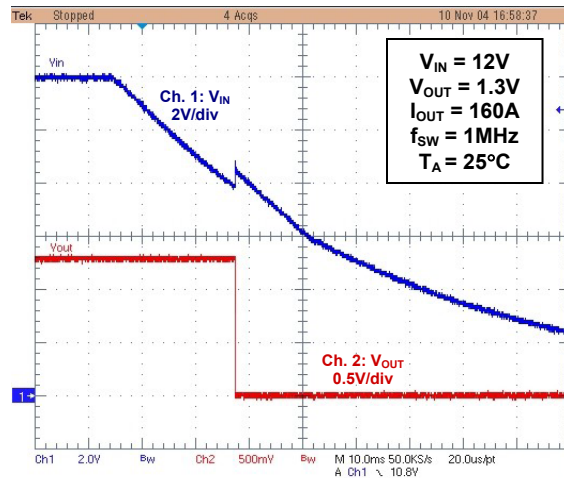

Fig. 8: Power Down Waveform

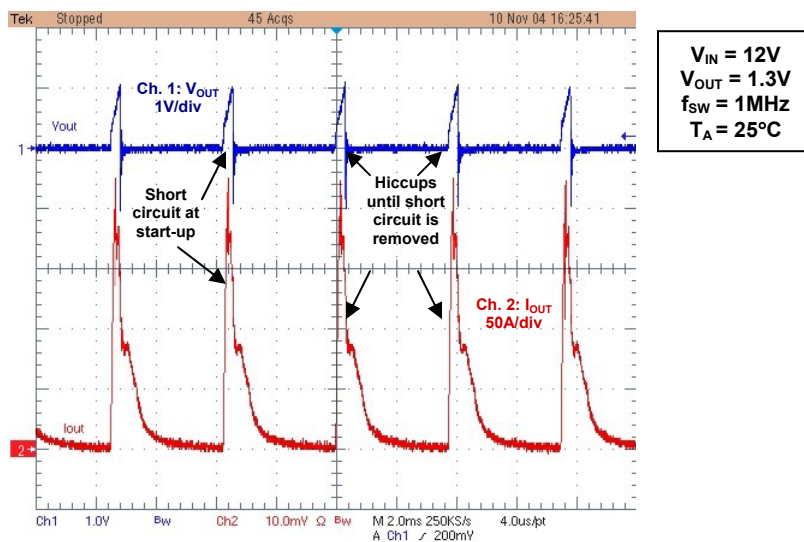
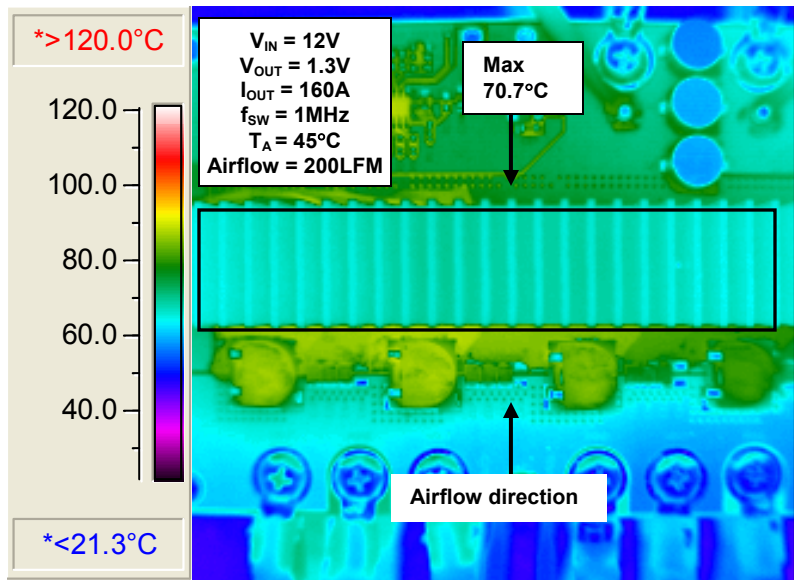
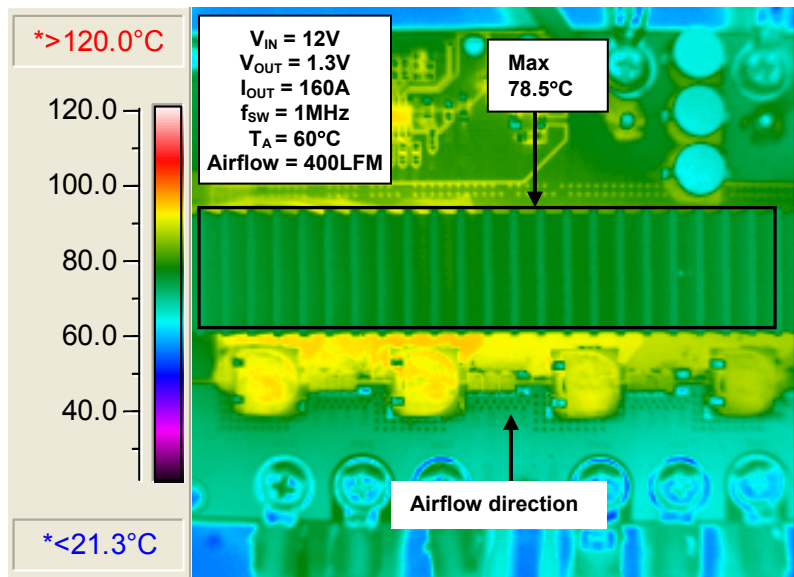

Fig. 9: Short Circuit Condition Waveform



**Board Temperature @ 1mm from edge of module:**

$T_{PCB} (U2): 83.4^\circ C$   
 $T_{PCB} (U3): 82.7^\circ C$   
 $T_{PCB} (U4): 82.3^\circ C$   
 $T_{PCB} (U5): 79.2^\circ C$



**Board Temperature @ 1mm from edge of module:**

$T_{PCB} (U2): 88.9^\circ C$   
 $T_{PCB} (U3): 87.5^\circ C$   
 $T_{PCB} (U4): 87.3^\circ C$   
 $T_{PCB} (U5): 85.1^\circ C$

**Fig. 10: Thermal Images With Board and Heatsink Temperatures**

**Adjusting the Over-Current Limit**

R5, R7, R8, and R9 are the resistors used to adjust the over-current trip point. The trip point is a function of the controller and corresponds to the per phase output current indicated on the x-axis of Fig. 11. For example, selecting 3.65k resistors will set the trip point of each phase to 66A. (Note: Fig. 11 is based on iP2003A, T<sub>J</sub> = 125°C. The trip point will be higher than expected if the reference board is cool and is being used for short circuit testing.)

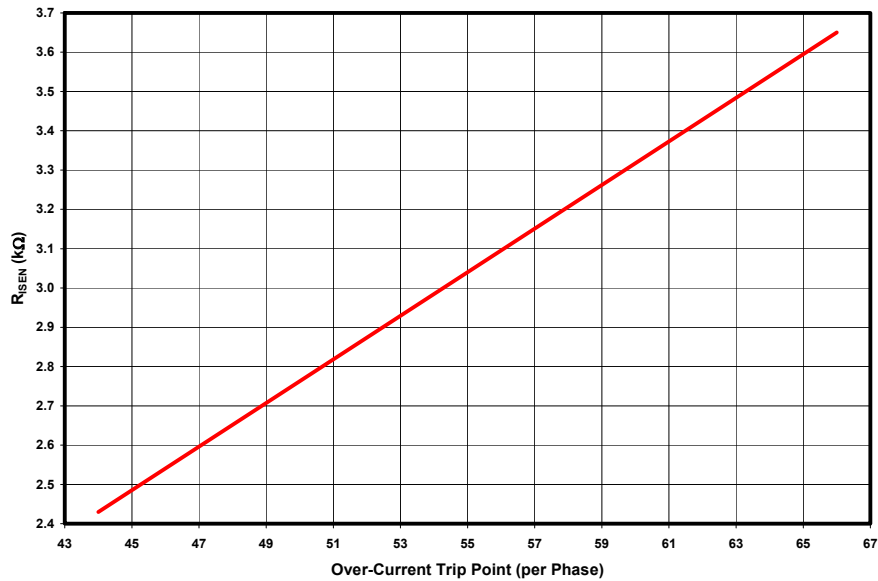

**Fig. 11: R<sub>ISEN</sub> vs. Current (per Phase)**

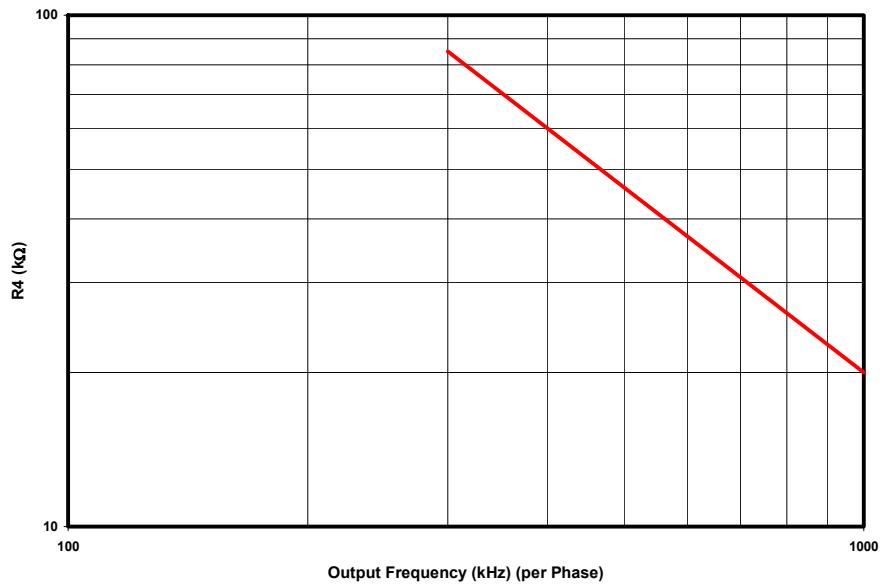

**Fig. 12: R4 vs. Frequency (per Phase)**

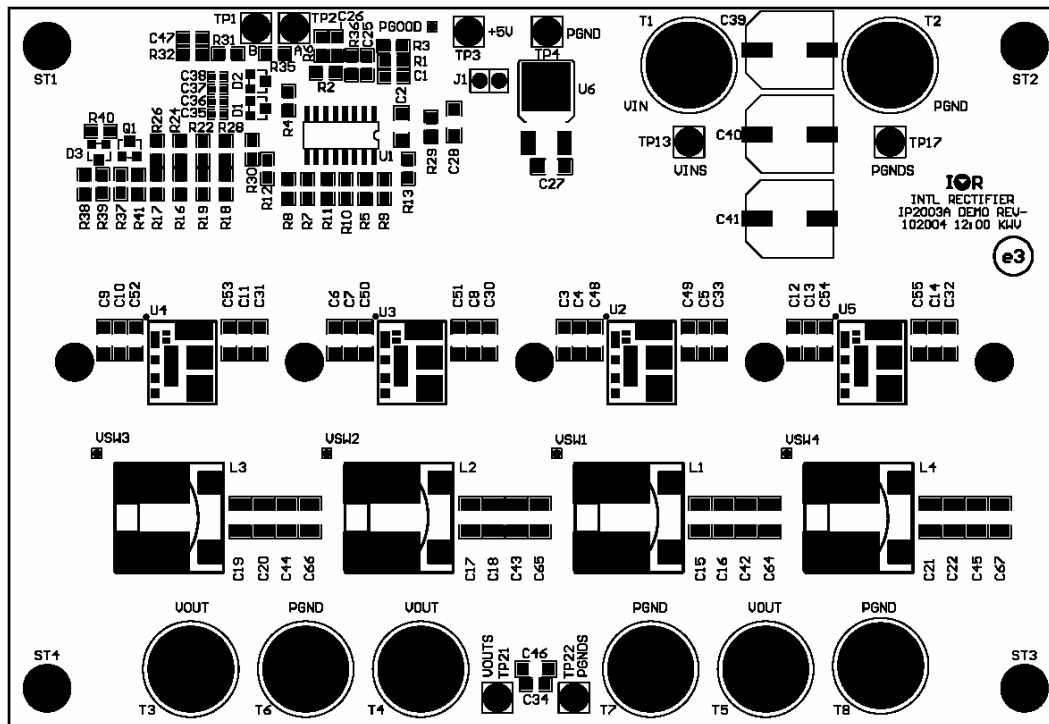
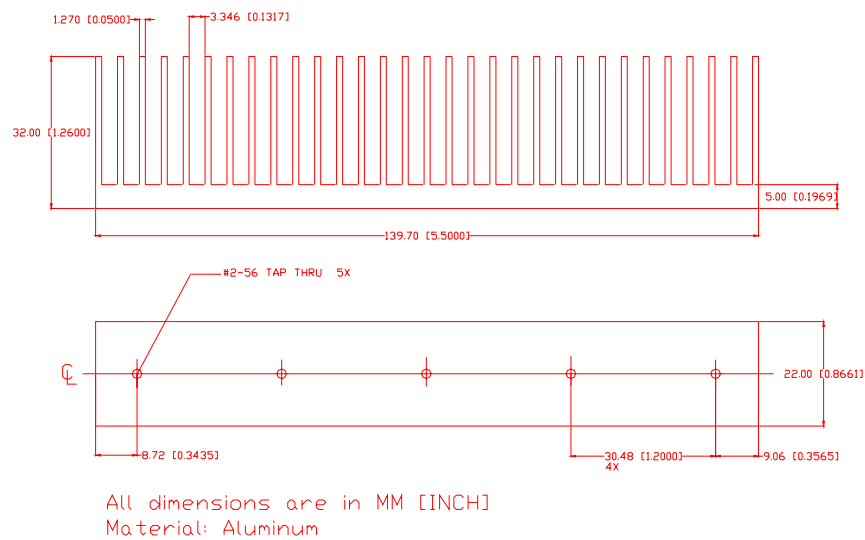

Fig. 13: Component Placement Top Layer



## Heatsink Notes:

- 1) Always use the supplied Berquist Gap Pad™ A3000 thermal interface material with heatsink.
- 2) Torque 5 x #2-56 machine screws to 15 +/-1 in-oz.
- 3) The heatsink is optimized for 400 LFM with unconfined airflow. Performance will improve with more airflow or confined airflow.
- 4) Airflow direction should be parallel to fins for maximum performance.

Fig. 14: Heatsink Specification

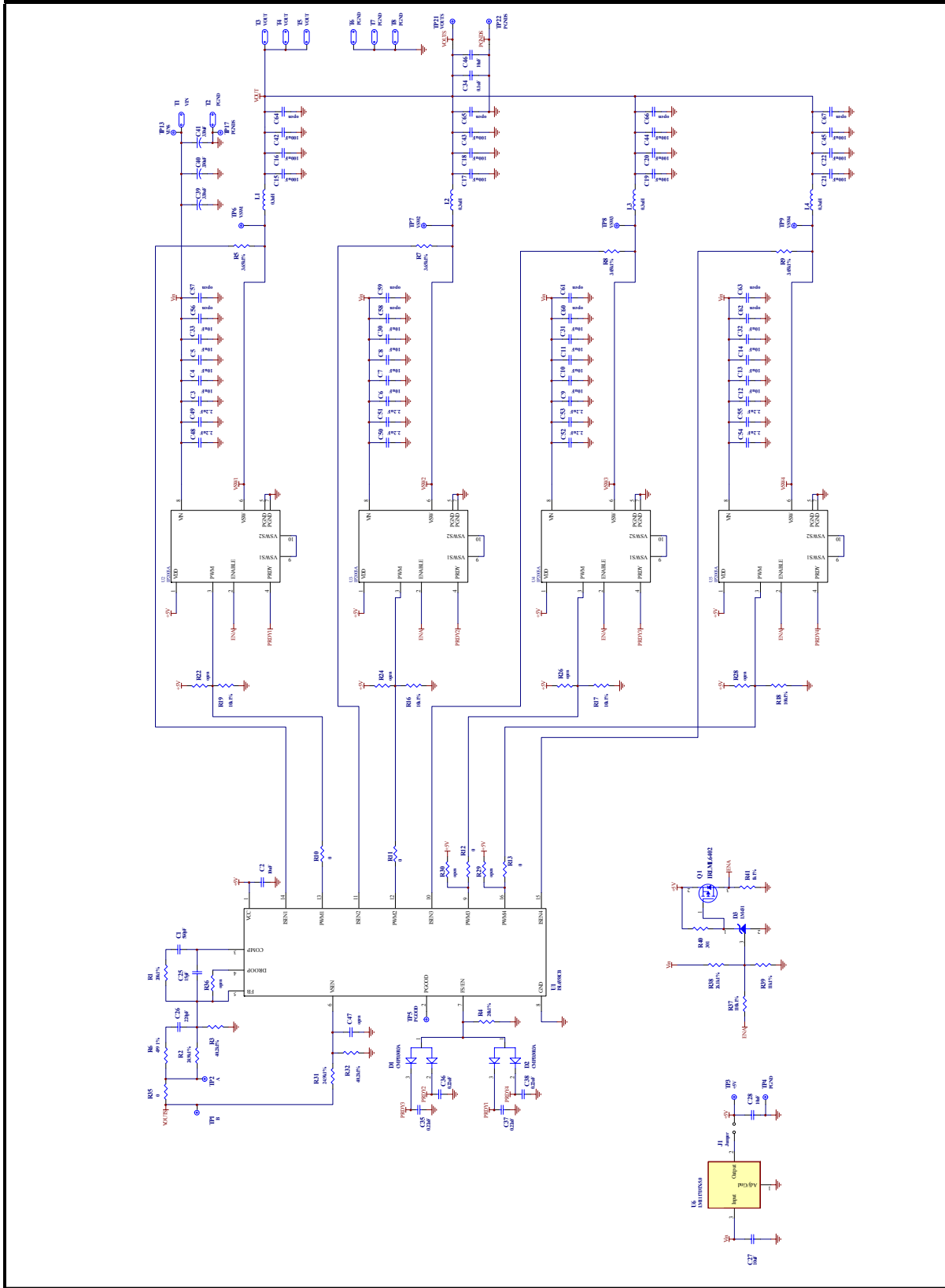

**Fig. 15: Reference Design Schematic**

# IRDCiP2003A-C

Quantity	Designator	Description	Size	Manufacturer	Part Number
1	C1	capacitor, NPO, 560pF, 50V, 5%	0805	ROHM	MCH215A561JP
20	C10, C11, C12, C13, C14, C2, C27, C28, C3, C30, C31, C32, C33, C4, C46, C5, C6, C7, C8, C9	capacitor, X5R, 10.0uF, 16V, 10%	1206	Murata	GRM31CR61C106KC31B
12	C15, C16, C17, C18, C19, C20, C21, C22, C42, C43, C44, C45	capacitor, X5R, 100uF, 6.3V, 20%	1210	TDK	C3225X5R0J107M
1	C25	capacitor, NPO, 15.0pF, 50V, 5%	0805	ROHM	MCH215A150JK
1	C26	capacitor, NPO, 220pF, 50V, 5%	0805	Phycomp	0805C6221J9BB0
1	C34	capacitor, X7R, 0.100uF, 50V, 10%	0805	ROHM	MCH215C104KP
4	C35, C36, C37, C38	capacitor, X5R, 0.22uF, 6.3V, 10%	0803	TDK	C1608X5R0J224K
3	C39, C40, C41	capacitor, polymer, 330uF, 16V, 20%	SMD	Sanyo	165VP330M
8	C48, C49, C50, C51, C52, C53, C54, C55	capacitor, X7R, 2.20uF, 16V, 10%	1206	MuRata	GRM31MR71C225KC11L
2	D1, D2	diode, general purpose, 200V, 600mA	SOT23	Central semiconductor	CMPD3003A
1	D3	regulator, zener shunt, 100mA, 2.5 - 36V, 0 to +70°C	SOT23	National Semiconductor	LM431CCM3
4	GP1, GP2, GP3, GP4	heatsink hardware, gap pad, 0.508mm, A3000	13mm x 13mm	Bergquist Company	BG414538
1	Heatsink	hardware, heatsink, 31 fins, 1.26 inch	5.5in x 0.8661in	IRF DWG#	21-0058
4	HN1, HN2, HN3, HN4	hardware, hexnut, 4-40	-	Building Fasteners	HNZ440
5	HS1, HS2, HS3, HS4, HS5	heatsink hardware, machine screw, 2-56, 3/8 inch	-	McMaster Carr	92196A079
5	HW1, HW2, HW3, HW4, HW5	heatsink hardware, flat washer, #2, 3/32 inch ID, 3/16 inch OD	-	McMaster Carr	98370A003
1	J1	hardware, test point, 233 mils, 40 mils	2 pin	Samtec	TSW-102-08-LS
1	J1-1	hardware, shunt, 100 mils	-	Samtec	SNT-100-BKT
4	L1, L2, L3, L4	inductor, ferrite, 0.30uH, 36A, 20%	SMT	Panasonic	ETQP2HOR3BFA
1	PCB	iP2003A, demo board, lead free	3.75in x 5.50in	-	-
1	Q1	P-FET, -3.7A, 65m, VDS -20V, VGS 0.95V	SOT23	IRF	IRLML6402
2	R1, R4	resistor, thick film, 20.0K, 1/8W, 1%	0805	KOA	RK73H2A2002F
5	R10, R11, R12, R13, R35	resistor, thick film, 0, 1/8W, <50m	0805	ROHM	MCR10EZHU000
4	R16, R17, R18, R19	resistor, thick film, 10.0K, 1/8W, 1%	0805	KOA	RK73H2A1002F
2	R2, R31	resistor, thick film, 24.9K, 1/8W, 1%	0805	KOA	RK73H2A2492F
2	R3, R32	resistor, thick film, 40.2K, 1/8W, 1%	0805	KOA	RK73H2A4022F
1	R37	resistor, thick film, 110K, 1/8W, 1%	0805	KOA	RK73H2A1103F
1	R38	resistor, thick film, 26.1K, 1/8W, 1%	0805	KOA	RK73H2A2612F
1	R39	resistor, thick film, 11.0K, 1/8W, 1%	0805	KOA	RK73H2A1102F
1	R40	resistor, thick film, 301, 1/8W, 1%	0805	KOA	RK73H1J3010F
1	R41	resistor, thick film, 1.00K, 1/8W, 1%	0805	KOA	RK73H2A1001F
4	R5, R7, R8, R9	resistor, thick film, 3.65K, 1/8W, 1%	0805	KOA	RK73H2A3651F
1	R6	resistor, thick film, 499, 1/8W, 1%	0805	KOA	RK73H2A4990F
8	SC1, SC2, SC3, SC4, SC5, SC6, SC7, SC8	hardware, hexnut, 10-24	-	McMaster Carr	92671A011
4	ST1, ST2, ST3, ST4	hardware, stand off, 4-40, 2	aluminium	Keystone	8412
8	T1-1, T2-1, T3-1, T4-1, T5-1, T6-1, T7-1, T8-1, TP1, TP13, TP17, TP2, TP21, TP22, TP3, TP4	hardware, machine screw, 10-24, 3/4	-	McMaster Carr	94070A245
8	TP1, TP13, TP17, TP2, TP21, TP22, TP3, TP4	hardware, test point, 90 mils, 112 x 150 mils	SMT	Keystone	5016
1	U1	IC analog, PWM controller, 4.5 - 5.5V, 0.8 - 5V, 0 - 70°C	16 Ld SOIC	Intersil	ISL6558CB
4	U2, U3, U4, U5	power block, DC-DC, 3.0 - 12.6V, 0.9 - 3.3V	11 x 9 x 2.6mm	IRF	IP2003A
1	U6	IC analog, LDO linear regulator, 5.0V, 800mA, 0 - 125°C	TO-252	National Semiconductor	LM1117DTX-5.0

**Table 1: Reference Design Bill of Materials**

Refer to the following application notes for detailed guidelines and suggestions when implementing iPOWIR Technology products:

### AN-1028: Recommended Design, Integration and Rework Guidelines for International Rectifier's iPowIR Technology BGA and LGA and Packages

This paper discusses optimization of the layout design for mounting iPowIR BGA and LGA packages on printed circuit boards, accounting for thermal and electrical performance and assembly considerations. Topics discussed includes PCB layout placement, and via interconnect suggestions, as well as soldering, pick and place, reflow, inspection, cleaning and reworking recommendations.

### AN-1030: Applying iPOWIR Products in Your Thermal Environment

This paper explains how to use the Power Loss and SOA curves in the data sheet to validate if the operating conditions and thermal environment are within the Safe Operating Area of the iPOWIR product.

### AN-1047: Graphical solution for two branch heatsinking Safe Operating Area

Detailed explanation of the dual axis SOA graph and how it is derived.

*Use of this design for any application should be fully verified by the customer. International Rectifier cannot guarantee suitability for your applications, and is not liable for any result of usage for such applications including, without limitation, personal or property damage or violation of third party intellectual property rights.*

**IR WORLD HEADQUARTERS:** 233 Kansas St., El Segundo, California 90245, USA Tel: (310) 252-7105  
 TAC Fax: (310) 252-7903