

XC9119D10A Series



1MHz, PWM Controlled,
Step-Up DC/DC Converter, Ceramic Capacitor Compatible

- ◆ Operating Voltage Range : 2.5V ~ 6.0V
- ◆ Output Voltage Externally Set-Up
: $V_{ref} = 1.0V \pm 2.0\%$
(Can be set freely up to 19.5V)
- ◆ Oscillation Frequency
: 1.0MHz (Accuracy $\pm 20\%$)
- ◆ High Efficiency : 86%
($V_{DD}=3.6V, V_{OUT}=15V, I_{OUT}=10mA$)
- ◆ Ultra Small Packages
: SOT-25, USP-6C

GENERAL DESCRIPTION

The XC9119D01A series is 1MHz, PWM controlled step-up DC/DC converter, designed to allow the use of ceramic capacitors. With a built-in 2.0Ω switching transistor, the XC9119D01A series can easily provide a step-up operation by using only a coil, a diode, a capacitor, and a resistor, connected externally.

Since output voltage up to 19.5V (Maximum Lx operating voltage: 20V) can be derived with reference voltage supply of 1.0V ($\pm 2.0\%$) and external components, the series can easily supply high voltage for various general-purpose power supplies, LCD panels and organic EL displays.

With a high switching frequency of 1.0MHz, a low profile and small board area solution can be achieved using a chip coil and an ultra small ceramic output capacitor.

With the current limit function (400mA (TYP.): $V_{DD}=3.6V$), a peak current, which flows through built-in driver transistors can be limited. Soft-start time can be adjusted by external resistors and capacitors. The stand-by function enables the output to be turned off (CE 'L'), that is, the supply current will be less than 1.0 μ A.

TYPICAL APPLICATION CIRCUIT

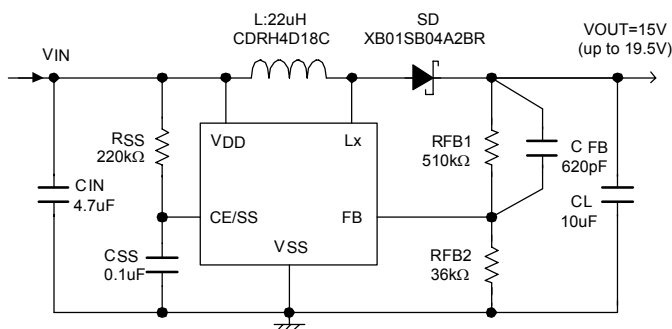

APPLICATIONS

- Organic electroluminescence display (OELD)
- Power supplies for LCD panels
- Various general-purpose power supplies

FEATURES

- Operating Voltage Range:** 2.5V ~ 6.0V
- Output Voltage Range** : Up to 19.5V externally set-up
: Reference voltage 1.0V $\pm 2.0\%$
- Oscillation Frequency** : 1.0MHz $\pm 20\%$
- ON Resistance** : 2.0Ω ($V_{DD}: 3.6V, V_{DS}: 0.4V$)
- Efficiency** : 86%
($V_{OUT}=15V, V_{DD}=3.6V, I_{OUT}=10mA$)
- Control** : PWM control
- Stand-by function** : $I_{STB}=1.0\mu A$ (MAX.)
- Load Capacitor** : Low ESR cap. such as a ceramic capacitor compatible
- Lx Limit Current** : 400mA ($V_{DD}: 3.6V$)

TYPICAL PERFORMANCE CHARACTERISTICS

○ Efficiency vs. Output Current

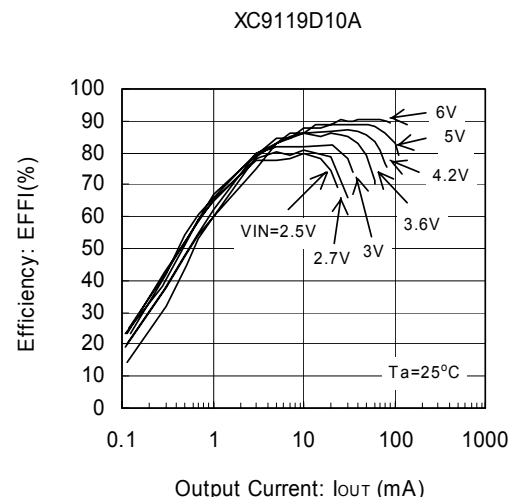

■ PIN CONFIGURATION

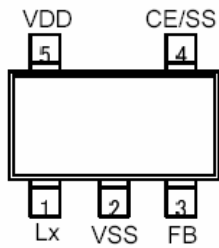

SOT-25
(TOP VIEW)

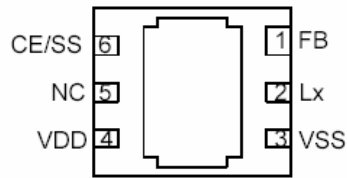

USP-6C
(BOTTOM VIEW)

*The dissipation pad for the USP-6C package should be solder-plated in recommended mount pattern and metal masking so as to enhance mounting strength and heat resistance. If the pad needs to be connected to other pins, it should be connected to the VSS pin.

■ PIN ASSIGNMENT

PIN NUMBER		PIN NAME	FUNCTION
SOT-25	USP-6C		
1	2	Lx	Switch
2	3	Vss	Ground
3	1	FB	Voltage Feedback
4	6	CE/SS	Chip Enable/ Soft Start
5	4	VDD	Power Input
-	5	NC	No Connection

■ CE PIN FUNCTION

CE/SS PIN	OPERATIONAL STATE
H	Operation
L	Shut-down

■ PRODUCT CLASSIFICATION

● Ordering Information

XC9119D①②③④⑤

DESIGNATOR	DESCRIPTION	SYMBOL	DESCRIPTION
①②	Output Voltage	10	: FB voltage
③	Oscillation Frequency	A	: 1MHz
④	Package	M	: SOT-25
		E	: USP-6C
⑤	Device Orientation	R	: Embossed tape, standard feed
		L	: Embossed tape, reverse feed

■ PACKAGING INFORMATION

● SOT-25

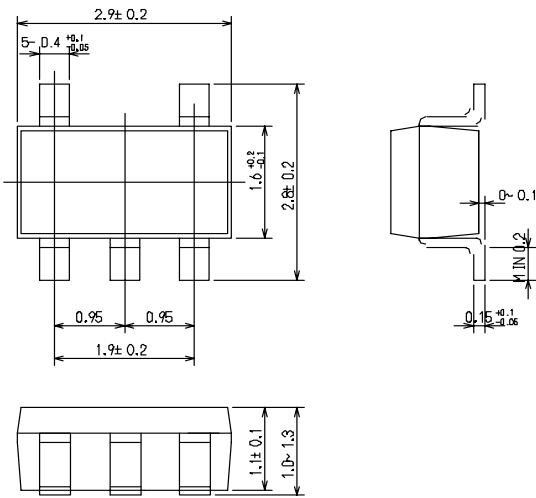

● USP-6C

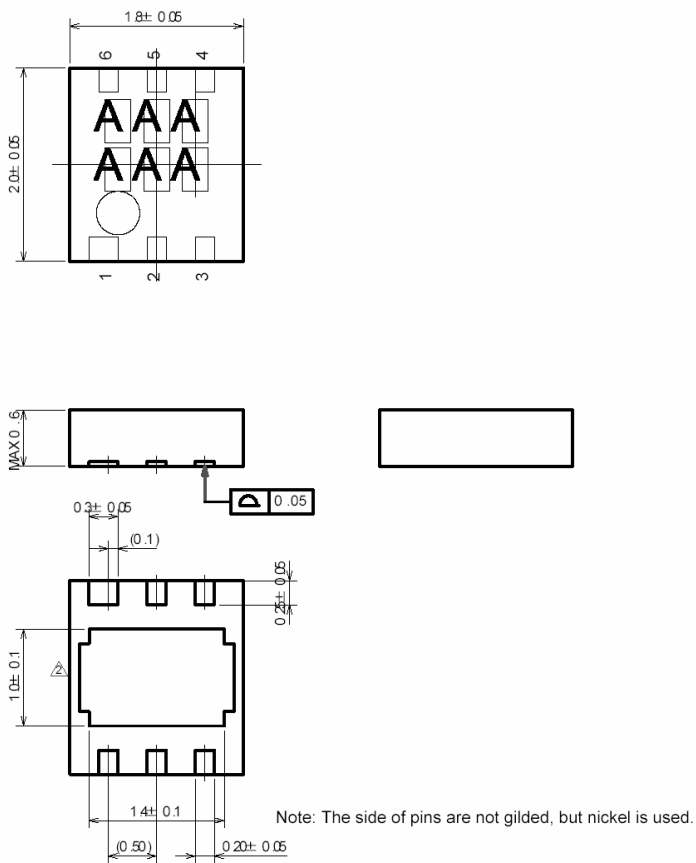

XC9119D10A Series

MARKING RULE

● SOT-25

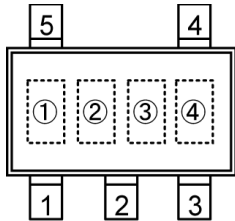

SOT-25
(TOP VIEW)

① Represents product series

MARK	PRODUCT SERIES
L	XC9119xxxxMx

② Represents Lx overvoltage limit

MARK	Lx OVERVOLTAGE LIMIT	PRODUCT SERIES
D	Not Available	XC9119DxxxMx

③ Represents oscillation frequency

MARK	OSCILLATION FREQUENCY	PRODUCT SERIES
A	1MHz	XC9119xxxAMx

④ Represents production lot number

0 to 9 and A to Z, or inverted characters 0 to 9 and A to Z repeated.
(G, I, J, O, Q, W excepted)

● USP-6C

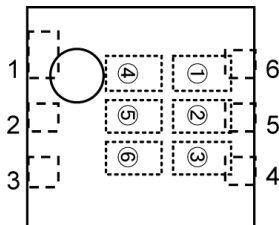

USP-6C
(TOP VIEW)

① Represents product series

MARK	PRODUCT SERIES
V	XC9119xxxxDx

② Represents Lx overvoltage limit

MARK	Lx OVERVOLTAGE LIMIT	PRODUCT SERIES
D	Not Available	XC9119DxxxDx

③④ Represents FB voltage

MARK		FB VOLTAGE (V)	PRODUCT SERIES
③	④		
1	0	1.0	XC9119x10xDx

⑤ Represents oscillation frequency

MARK	OSCILLATION FREQUENCY	PRODUCT SERIES
A	1MHz	XC9119xxxADx

⑥ Represents production lot number

0 to 9 and A to Z repeated (G, I, J, O, Q, W excepted)
* No character inversion used.

■ BLOCK DIAGRAM

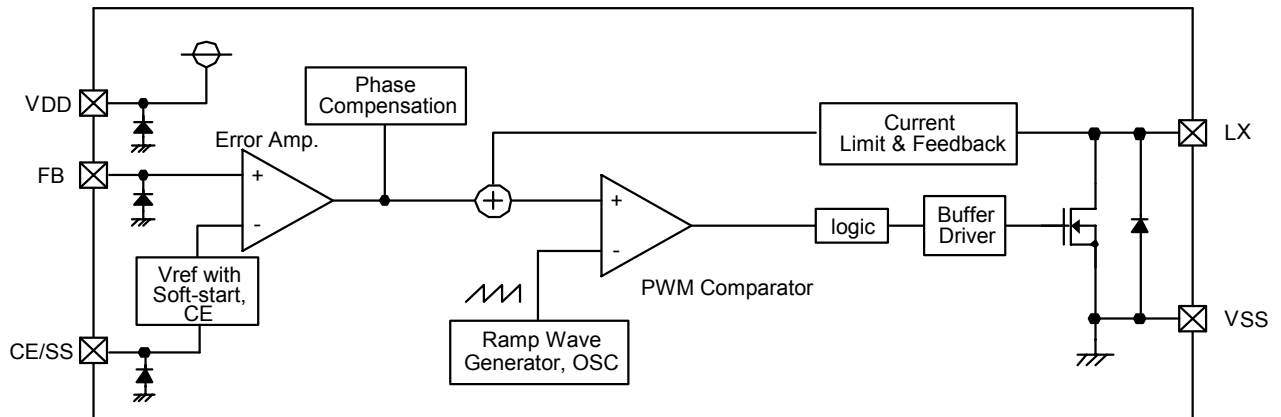

■ ABSOLUTE MAXIMUM RATINGS

Ta = 25°C

PARAMETER	SYMBOL	RATINGS	UNITS
VDD Pin Voltage	VDD	Vss – 0.3 ~ 7.0	V
Lx Pin Voltage	VLx	Vss – 0.3 ~ 22.0	V
FB Pin Voltage	VFB	Vss – 0.3 ~ 7.0	V
CE Pin Voltage	VCE	Vss – 0.3 ~ 7.0	V
Lx Pin Current	ILx	1000	mA
Power Dissipation	SOT-25	Pd	mW
	USP-6C		
Operating Temperature Range	Topr	- 40 ~ + 85	°C
Storage Temperature Range	Tstg	- 55 ~ +125	°C

XC9119D10A Series

ELECTRICAL CHARACTERISTICS

XC9119D10AMR

Ta = 25 °C

PARAMETER	SYMBOL	CONDITIONS	MIN.	TYP.	MAX.	UNIT	CIRCUIT
FB Voltage	VFB	-	0.980	1.000	1.020	V	①
Line Regulation	$\frac{\Delta V_{FB}}{\Delta V_{IN} \cdot V_{FB}}$	$2.5 \leq V_{DD} \leq 6.0V$	-	0.05	0.20	%/V	①
Supply Voltage	VDD	-	2.5	-	6.0	V	①
Operation Start-up Voltage	VST1	IOUT=0mA	-	-	2.5	V	②
Supply Current 1	IDD1		-	450	700	μA	②
Supply Current 2	IDD2	FB=2.0V	-	55	110	μA	②
Stand-by Current	ISTB	VCE=0V	-	-	1.0	μA	③
Oscillation Frequency	FOSC	Same as IDD1	0.8	1.0	1.2	MHz	②
Maximum Duty Ratio	MAXDTY	Same as IDD1	86	92	98	%	②
Efficiency (*1)	EFFI	VIN=VDD=3.6V, VOUT=15V, IOUT=10mA	-	86	-	%	①
Current Limit	ILIM	VDD=3.6V	310	400	750	mA	④
Lx Operating Voltage Range	VLx	VOUT=18V	-	-	20.0	V	①
Lx Switch On Resistance	RSWON	VDD=3.6V, VLx=0.4V, Rpull=10Ω	-	2.0	4.0	Ω	α
Lx Leak Current	ILxL	Same as ISTB	-	-	1	μA	③
CE "High" Voltage	VCEH	Applied voltage to CE when Lx pin voltage holding "H" level	0.65	-	-	V	②
CE "Low" Voltage	VCEL	Applied voltage to CE when Lx pin voltage holding "H" level	-	-	0.20	V	②
Soft-Start Threshold Voltage	VSST	FB=0.95V, Applied voltage to CE when Lx voltage holding "H" level	1.3	1.6	1.9	V	②
CE "High" Current	ICEH	Same as IDD2	-0.1	-	0.1	μA	③
CE "Low" Current	ICEL	Same as ISTB	-0.1	-	0.1	μA	③
FB "High" Current	IFBH	Same as IDD2	-0.1	-	0.1	μA	③
FB "Low" Current	IFBL	Same as ISTB	-0.1	-	0.1	μA	③

Test Condition: Unless otherwise stated, VIN=3.0V, VCE=3.0V, VFB=0V, Vpull=5.0V, Rpull=100Ω.

NOTE:

*1: $EFFI = \frac{\text{(output voltage} \times \text{output current)}}{\text{(input voltage)} \times \text{(input current)}} \times 100$

TYPICAL APPLICATION CIRCUIT

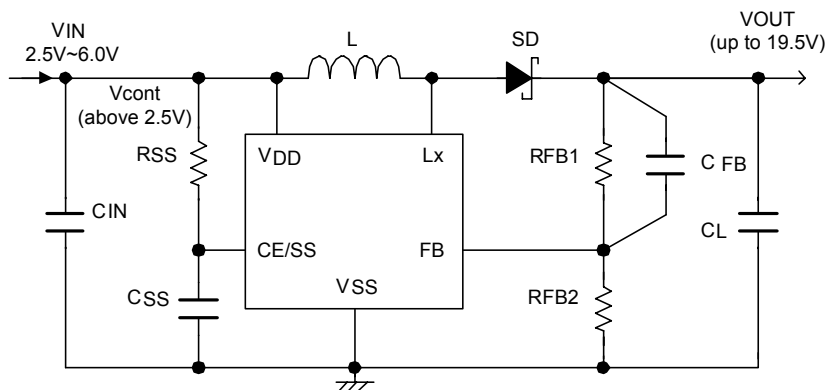

OPERATIONAL EXPLANATION

The XC9119D10A series consists of a reference voltage source, ramp wave circuit, error amplifier, PWM comparator, phase compensation circuit, driver transistor, current limiter circuit and others. The series ICs compare, using the error amplifier, the voltage of the internal reference voltage source with the feedback voltage from the FB pin. Phase compensation is performed on the resulting error amplifier output, to input a signal to the PWM comparator to determine the turn-on time during switching. The PWM comparator compares, in terms of voltage level, the signal from the error amplifier with the ramp wave from the ramp wave circuit, and delivers the resulting output to the buffer drive circuit to cause the Lx pin to output a switching duty cycle. This process is continuously performed to ensure stable output voltage. The current feedback circuit detects the N-channel MOS driver transistor's current for each switching operation, and modulates the error amplifier output signal to provide multiple feedback signals. This enables a stable feedback loop even when a low ESR capacitor, such as a ceramic capacitor, is used, ensuring stable output voltage.

<Reference Voltage Source>

The reference voltage source provides the reference voltage to ensure stable output voltage of the IC.

<Ramp Wave Circuit>

The ramp wave circuit determines switching frequency. The 1MHz (TYP.) of frequency is fixed internally. Clock pulses generated in this circuit are used to produce ramp waveforms needed for PWM operation.

<Error Amplifier>

The error amplifier is designed to monitor output voltage. The amplifier compares the reference voltage with the FB pin voltage. When a voltage lower than the reference voltage is fed back, the output voltage of the error amplifier increases. Gain and frequency characteristics of the error amplifier output are fixed internally as an optimize signal.

<Current Limit >

The current limit circuit of the XC9119D10A series monitors the current flowing through the N-channel MOS driver transistor connected to the Lx pin, and features a combination of the constant-current type current limit mode and the duty cycle limit of the next pulse.

- ①When the driver current is greater than a specific level, the constant-current type current limit function operates to turn off the pulses from the Lx pin at any given timing.
- ②The IC controls the next pulse to be smaller than the first pulse.

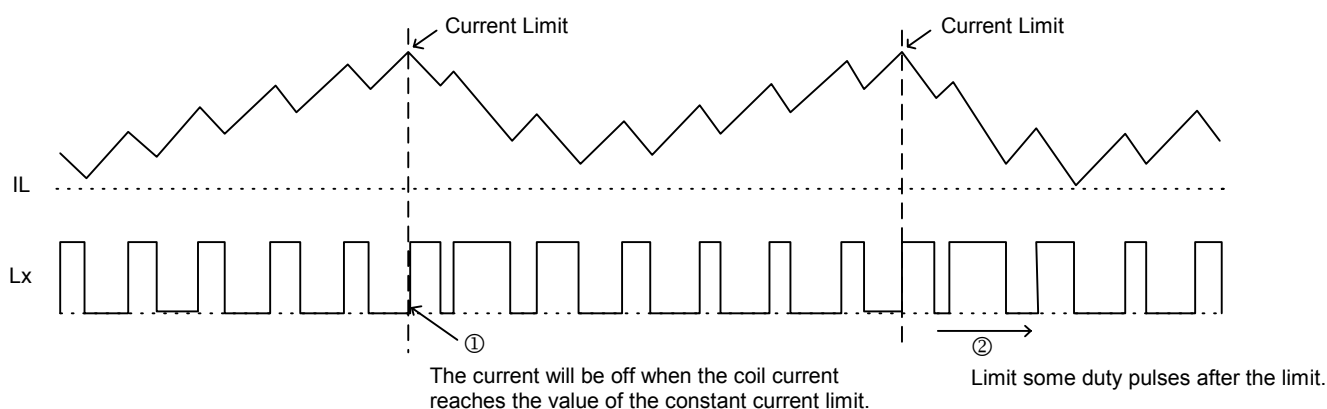

<CE Pin Function>

The operation of the XC9119D10A series will enter into the shut down mode when a low level signal is input to the CE pin. During the shut down mode, the supply current is 0 μ A (TYP.), with high impedance at the Lx pin. The IC starts its operation with a high level signal to the CE pin. The input to the CE pin is a CMOS input and the sink current is 0 μ A (TYP.). The hysteresis between the chip enable and the chip disable is 50mV (TYP.).

<Soft-Start Time>

Soft-start function operates when capacitors and resistors are connected to the CE/SS pin. With the Vref voltage limited by the CE/SS pin start-up voltage and applying the input to the error amps, the operation maintains a balance between the two inputs of the error amps. and controls the Lx pin's ON time so that it doesn't increase more than is necessary. Depending of current limit function, load current, step-up ratio, and external components, the IC takes about 500 μ s to 5mS to attain the setting voltage after applying the CE 'H' voltage even though the RSS is 0 Ω and a soft start capacitor C_{SS} is not connected. (For a numerical constant, please refer to Note on Use.) For longer soft-start time, please connect RSS and C_{SS}. Soft-start function operates while the CE pin voltage is between 0V to around 1.9V. Please be noted that if the CE/SS pin voltage does not start from 0V but is in intermediate potential when the power is turned on etc., soft start function may lose an effect and that will cause a high inrush current and ripple voltage.

OPERATIONAL EXPLANATION

<CE/SS (Pin No. 4): Chip Enable / Soft-Start Pin>

Pin No. 4 can be used as in either chip enable (CE) pin or soft-start (SS) pin. The IC takes about 5mS at most to attain the setting voltage after starting operation (CE 'H') even though the R_{SS} is 0Ω and the C_{SS} is not connected.

Soft-start function is good for setting a longer time than the start-up time when the R_{SS} is 0Ω and the C_{SS} is not connected. Soft-start operates while the CE pin voltage increases from 0V to around 1.9V. The following equation is used with the values of V_{cont} voltage, the R_{SS} and the C_{SS}.

$$T = C_{SS} \times R_{SS} \times \ln \left\{ \frac{V_{cont} - 1.6}{V_{cont}} \right\}$$

- Start-up waveform when the R_{SS} is 0Ω and the C_{SS} is not connected

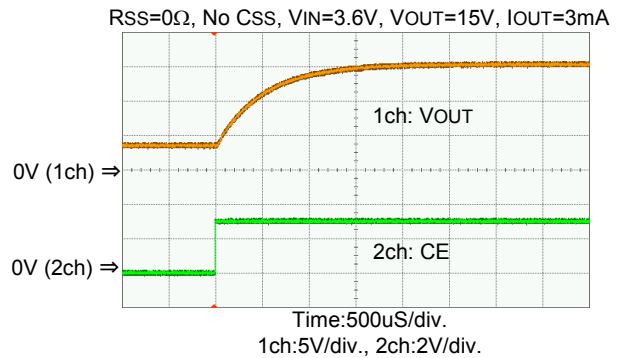

Ex.) When C_{SS}=0.1uF, R_{SS}=220kΩ, V_{cont}=5V,
 $T = -0.1e-6 \times 220e3 \times \ln \left\{ \frac{5-1.6}{5} \right\} = 33.94mS$

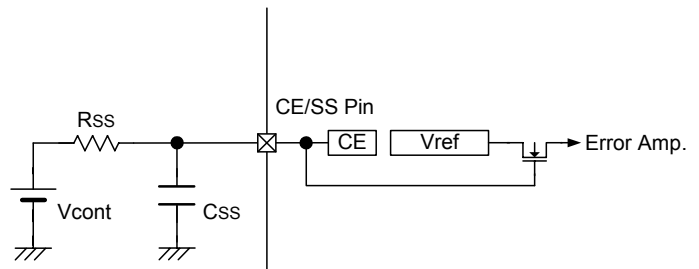

Ex.) Reference Circuit 1: N-ch Open Drain

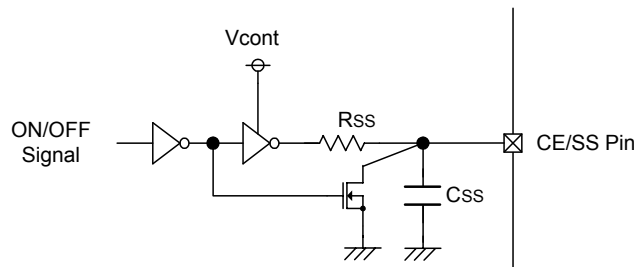

Ex.) Reference Circuit 2: CMOS Logic (Low Supply Current)

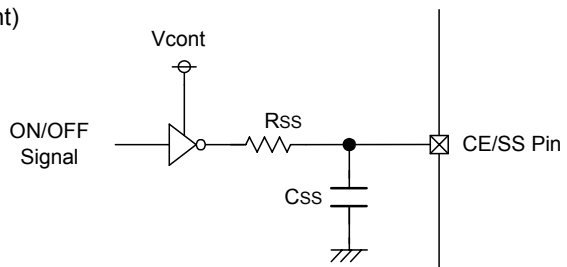

Ex.) Reference Circuit 3: CMOS Logic (Low Supply Current), Quick-Off

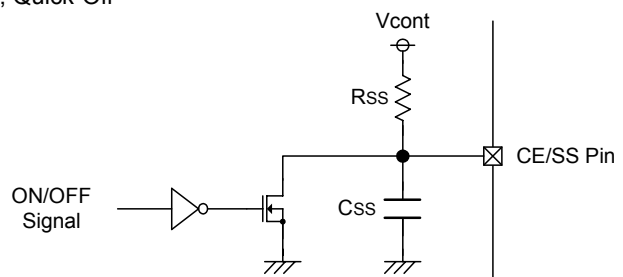

OPERATIONAL EXPLANATION (Continued)

<Lx (Pin No. 1): Switch Pin>

Please connect the anode of a Schottky barrier diode and inductor to the Lx pin.

<FB (Pin No. 3): Voltage Feedback Pin>

The reference voltage is 1.0V (TYP.). Output voltage is approximated by the following equation according to the value for two resistors (RFB1 and RFB2). The sum of the two resistors should be 1MΩ or less.

$$V_{OUT} = R_{FB1} / R_{FB2} + 1$$

Output voltage should be set as to fill $V_{OUT} < (\text{Maximum value of } V_{Lx}) - (V_F \text{ of Schottky diode})$.

Please adjust the CFB value of the speed-up capacitor for phase compensation so that $f_{zfb} = 1 / (2 \pi \times C_{FB} \times R_{FB1})$ will be about 500Hz. According to the usage, adjusting the inductance value, the load capacity value, and so on to the most suitable operation.

Typical example:

VOUT (V)	RFB1 (kΩ)	RFB2 (kΩ)	CFB (pF)
3.3	300	130	1000
5.0	300	75	1000
7.0	180	30	1800
10.0	270	30	1200
15.0	510	36	510
18.0	510	30	510

<VDD (Pin No. 5): Power Supply Pin>

Please connect an input by-pass capacitor (CIN).

Application Information

<Obtaining VDD from other source than VIN>

In case that the input voltage VIN and power source VDD in the step-up circuit are isolated, the circuit starts step-up operations with the input voltage less than 2.5V when voltage from 2.5V to 6.0V is applied to the power source. Please connect more than 1uF of CDD between the VDD pin and the VSS pin as close as possible.

Ex.) When VDD=3.6V, VIN=1.8V, VOUT=5.0V (RFB1=300kΩ, RFB2=75kΩ, CFB=1000pF, CL=10uF), the IC can operate up to IOUT=40mA.

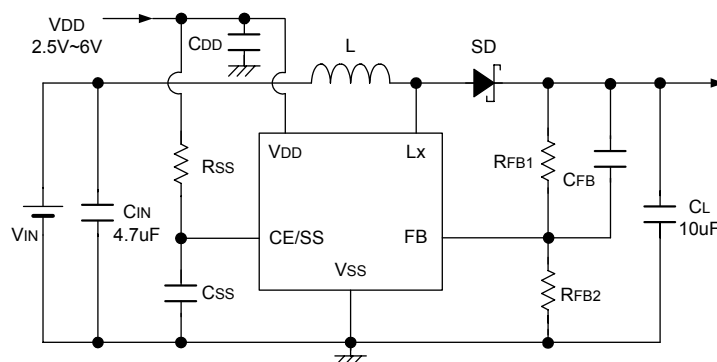

NOTES ON USE

1. Please do not exceed the value of stated absolute maximum ratings.
2. The DC/DC converter performance is greatly influenced by not only the ICs' characteristics, but also by those of the external components. Care must be taken when selecting the external components.
3. Make sure that the PCB GND traces are as thick as possible, as variations in ground potential caused by high ground currents at the time of switching may result in instability of the IC.
4. Please mount each external component as close to the IC as possible and use thick, short connecting traces to reduce the circuit impedance.
5. Please set up the output voltage value so that the Lx pin voltage does not exceed 20V.

TEST CIRCUITS

Circuit ①

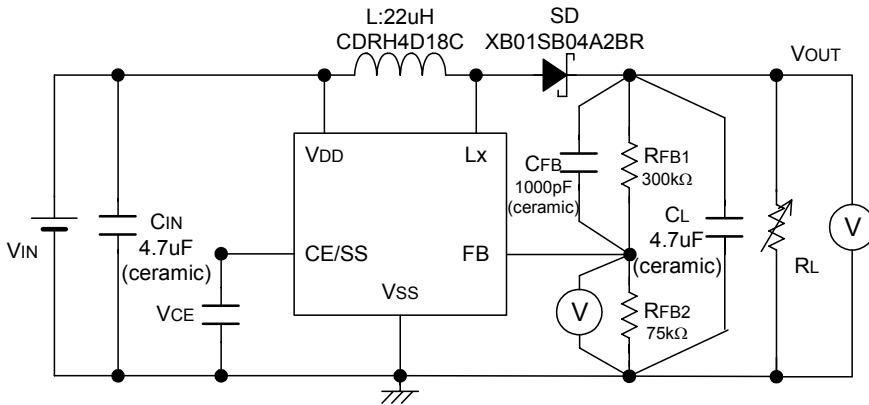

Circuit ②

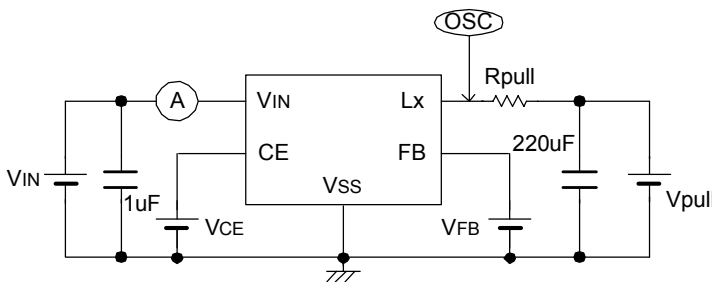

Circuit ③

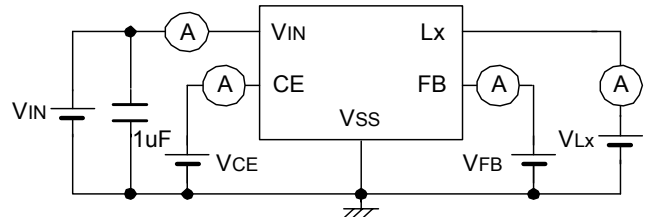

Circuit ④

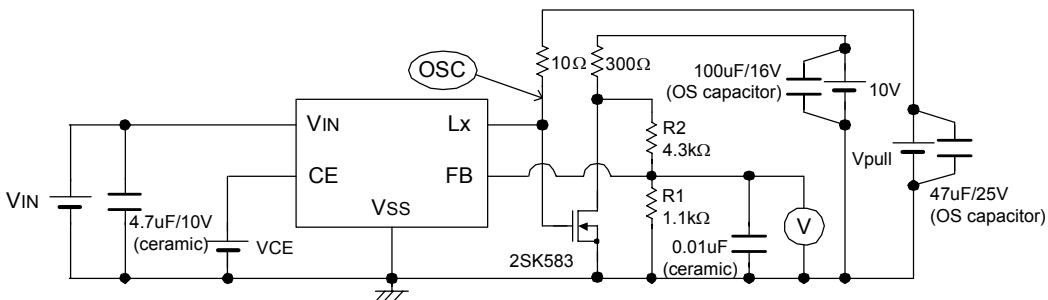

1. The measurement method of Lx On resistance RSWON

Using the circuit ②, Lx On resistance can be measured by adjusting Vpull voltage to set Lx voltage VLx x 0.4V when the driver transistor is ON. The oscilloscope is used for measuring the Lx voltage when the driver transistor is ON.

$$R_{SWON} = 0.4 / \{(V_{pull} - 0.4) / 10\}$$

2. The measurement method of current limit ILIM

Using the circuit ④, current limit ILIM can be calculate by the equation including Vpull voltage when FB voltage is decreased while Vpull voltage is adjusted and Lx voltage VLx when the driver transistor is ON. The oscilloscope is used for measuring the Lx voltage when the driver transistor is ON.

$$I_{LIM} = (V_{pull} - V_{Lx}) / R_{pull}$$

■ TYPICAL PERFORMANCE CHARACTERISTICS

(1) Output Voltage vs. Output Current

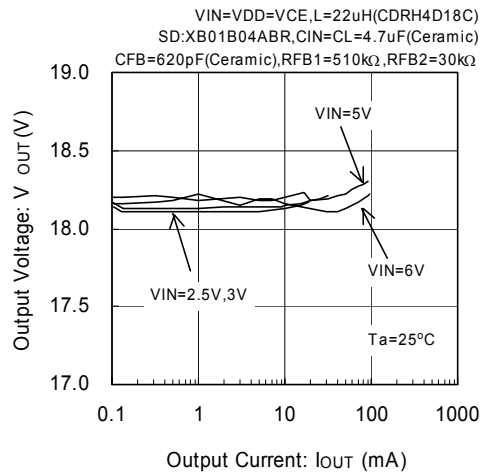
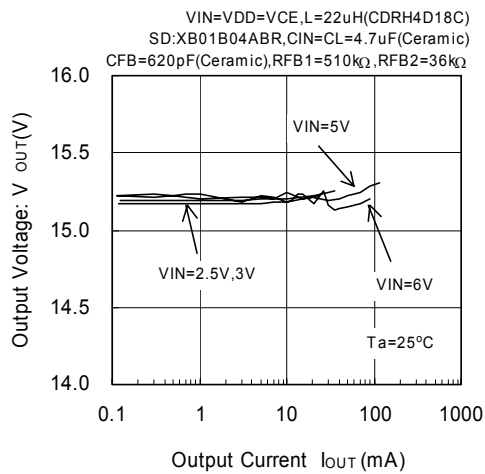
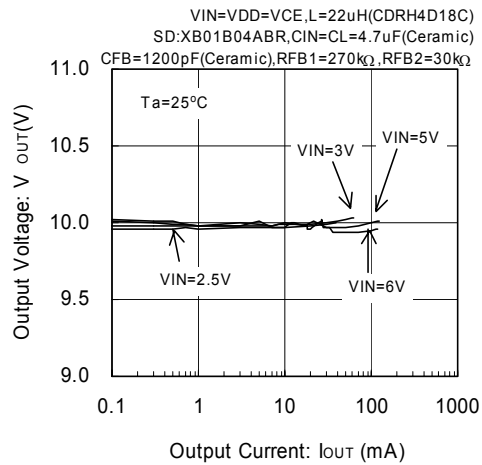
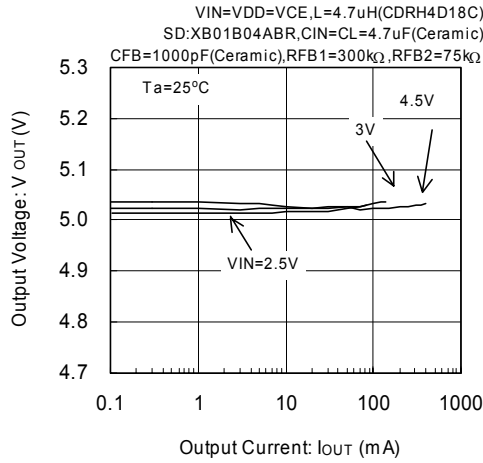

(2) Efficiency vs. Output Current

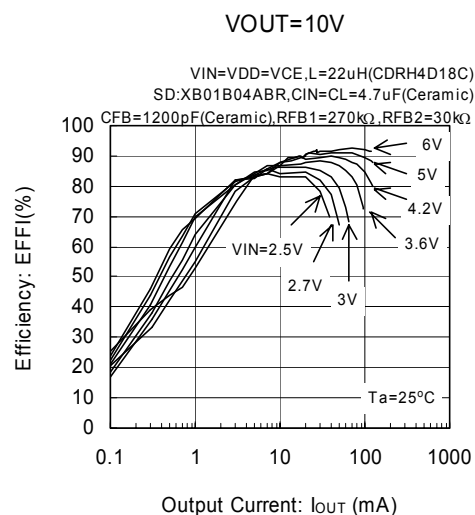
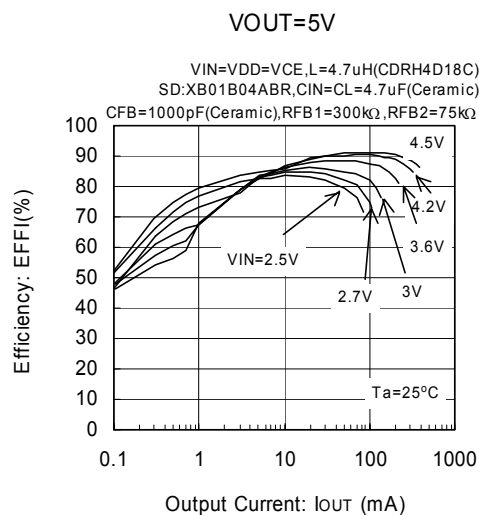

TYPICAL PERFORMANCE CHARACTERISTICS (Continued)

(2) Efficiency vs. Output Current (Continued)

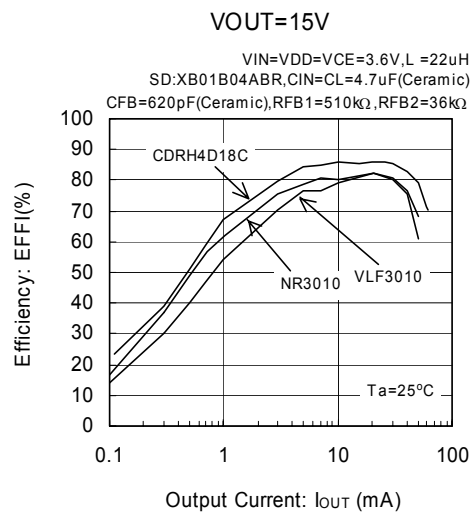
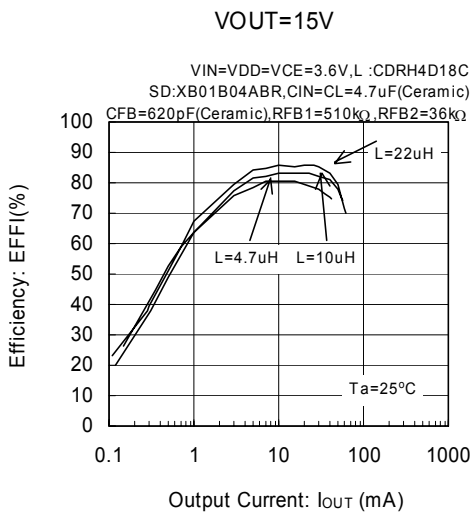
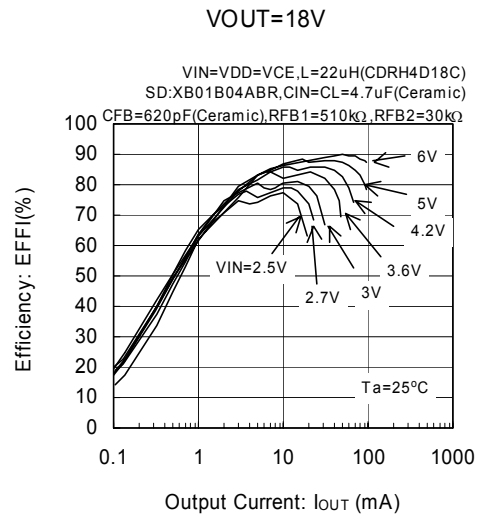
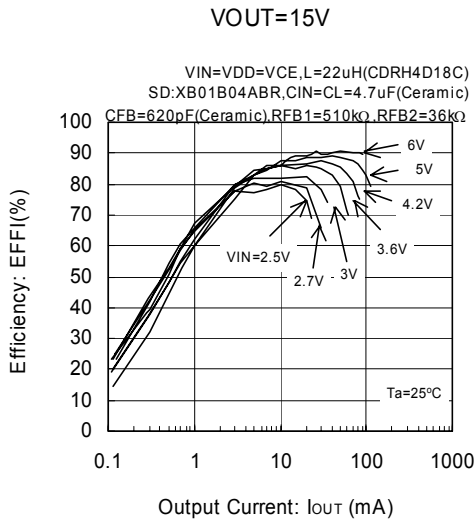

(3) Ripple Voltage vs. Output Current

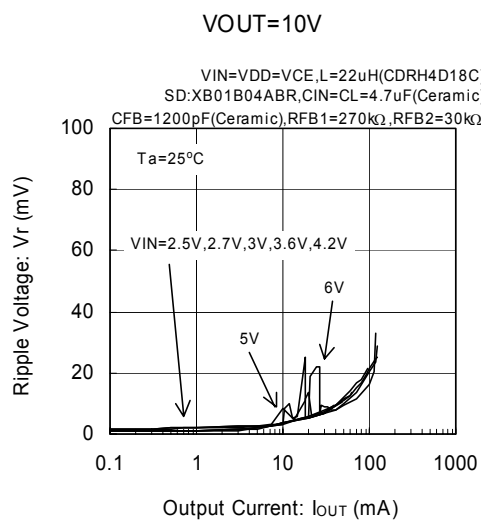
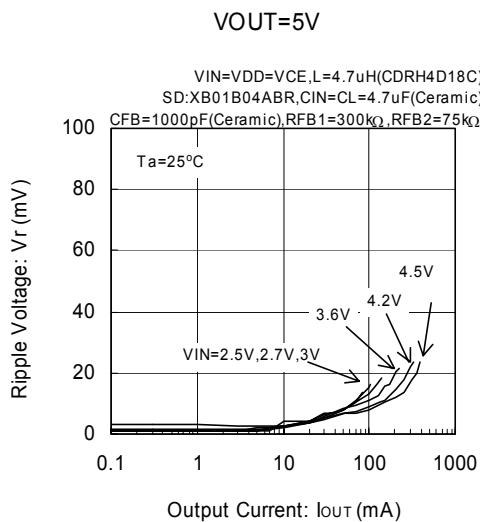

TYPICAL PERFORMANCE CHARACTERISTICS (Continued)

(3) Ripple Voltage vs. Output Current (Continued)

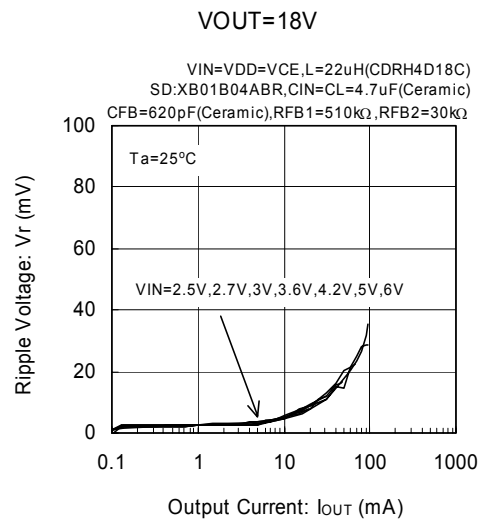
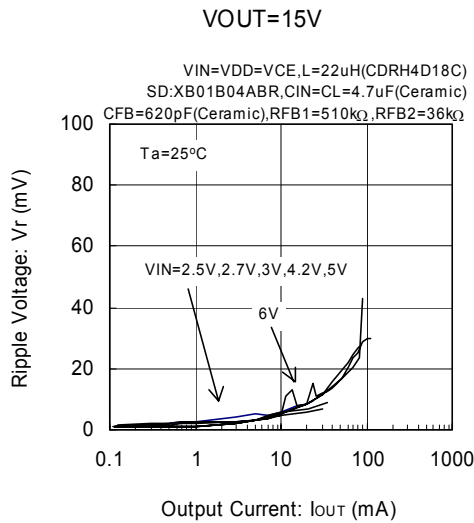

(4) Maximum Output Current vs. Input Voltage

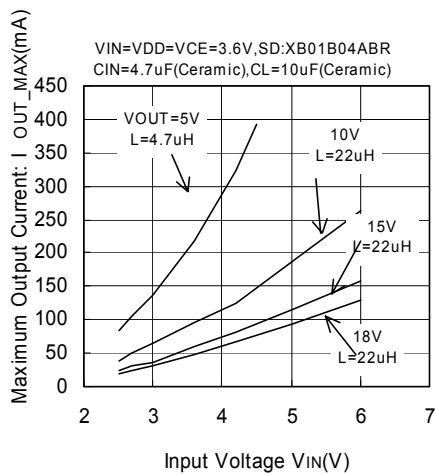

(5) Feedback Voltage vs. Chip Enable Voltage

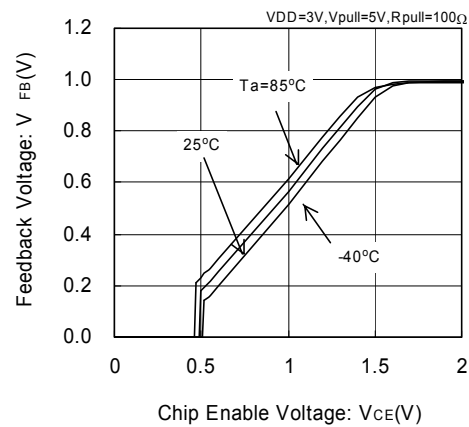

(6) Supply Current 1 vs. Supply Voltage

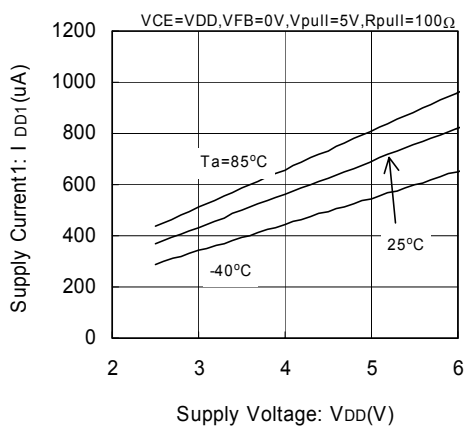

(7) Supply Current 2 vs. Supply Voltage

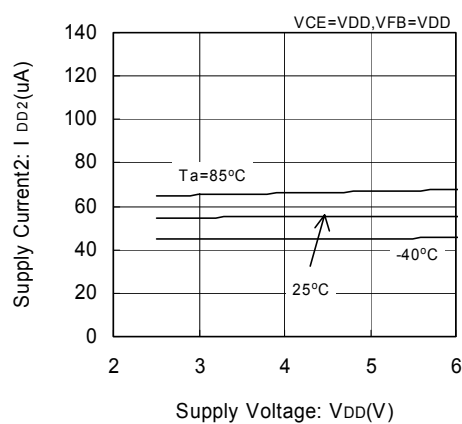

■ TYPICAL PERFORMANCE CHARACTERISTICS (Continued)

(8) Oscillation Frequency vs. Supply Voltage

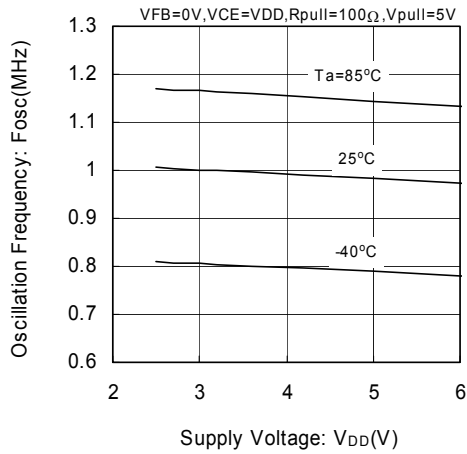

(9) Maximum Duty Cycle vs. Supply Voltage

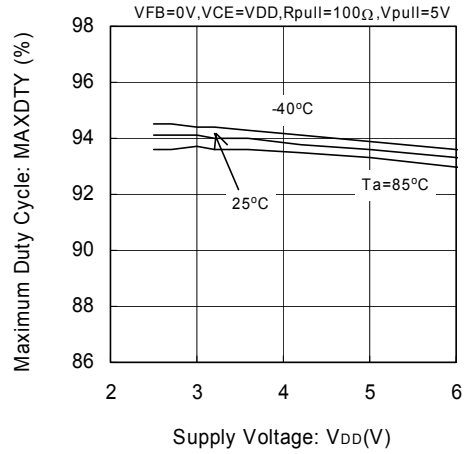

(10) Stand-by Current vs. Supply Voltage

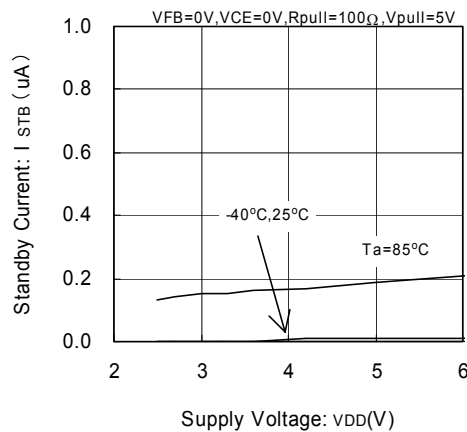

(11) Lx ON Resistance vs. Supply Voltage

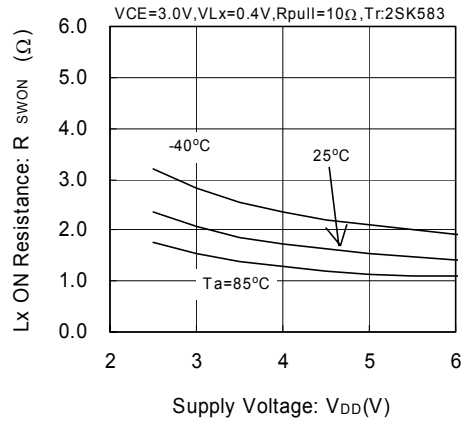

(12) Current Limit vs. Supply Voltage

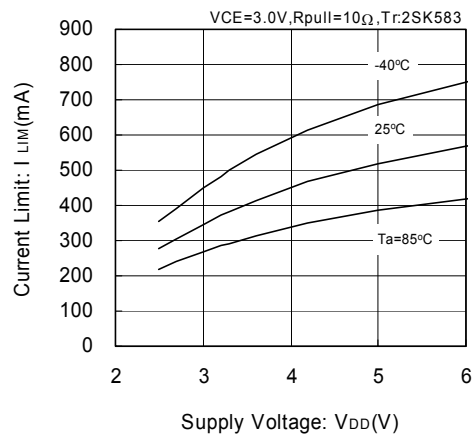

(13) Feedback Voltage vs. Supply Voltage

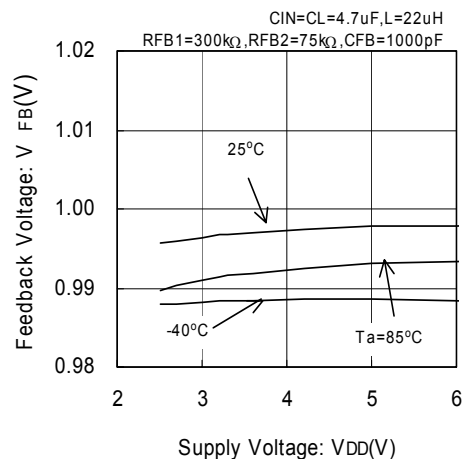

■ TYPICAL PERFORMANCE CHARACTERISTICS (Continued)

(14) CE 'H' Voltage vs. Supply Voltage

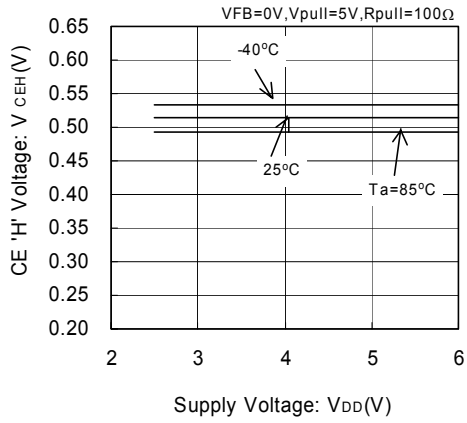

(15) CE 'L' Voltage vs. Supply Voltage

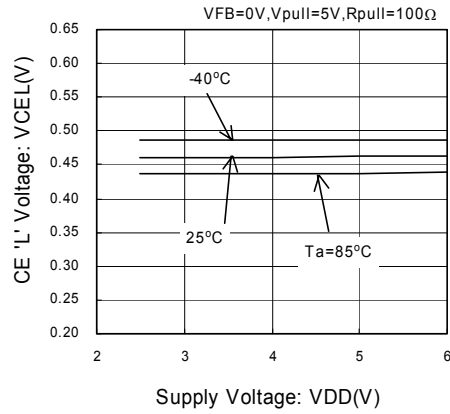

(16) Load Transient Response

VOUT=5V

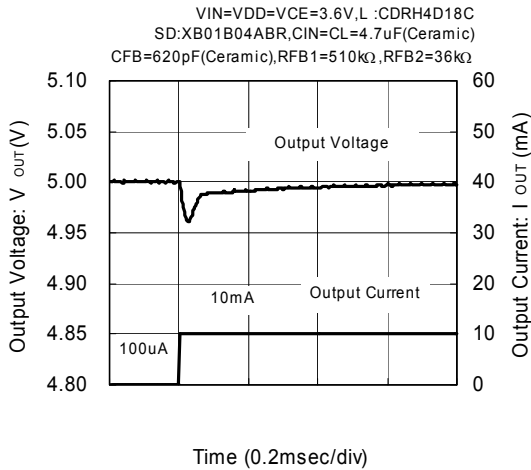

VOUT=5V

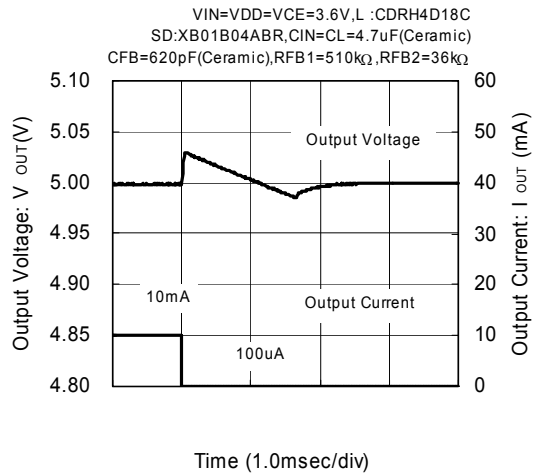

VOUT=15V

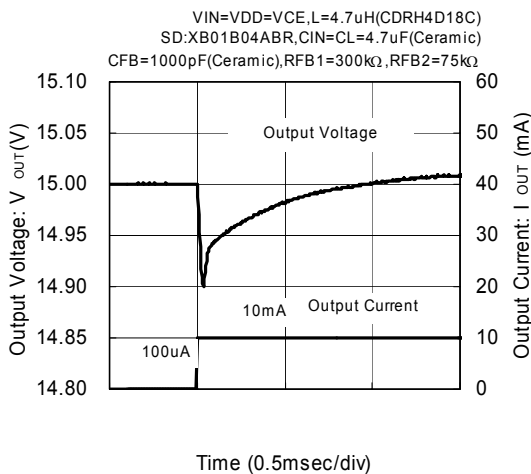

VOUT=15V

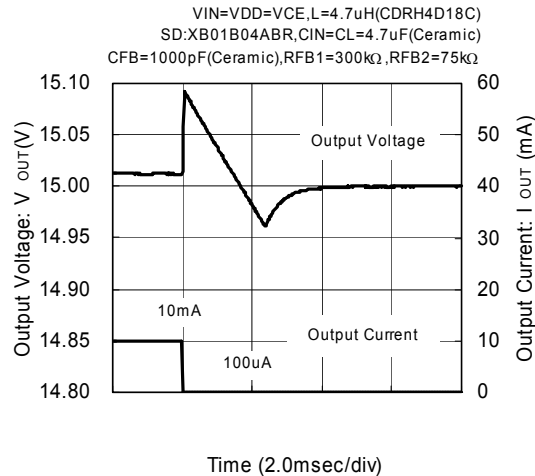

■ TYPICAL PERFORMANCE CHARACTERISTICS (Continued)

(17) Maximum Output Current vs. Input Voltage

