

# LNC701PS

## GaAlAs Semiconductor Laser

### ■ Features

- Low threshold current
- Stable single horizontal mode oscillation
- Long lifetime, high reliability

### ■ Applications

- Optical data processing devices
- Optical disk memory drive
- Optical measuring equipment

### ■ Absolute Maximum Ratings (Ta = 25°C)

Parameter		Symbol	Ratings	Unit
Radiant power		$P_O$	35	mW
Reverse voltage	Laser	$V_R$	2	V
	PIN	$V_R$ (PIN)	30	V
Power dissipation		$P_d$ (PIN)	100	mW
Operating ambient temperature		$T_{opr}$	-10 to +60	°C
Storage temperature		$T_{stg}$	-40 to +80	°C

### ■ Electro-Optical Characteristics (Ta = 25°C)

Parameter		Symbol	Conditions	min	typ	max	Unit
Threshold current		$I_{th}$	CW	10	20	30	mA
Operating current		$I_{OP}$	CW $P_O = 30\text{mW}$	30	55	70	mA
Operating voltage		$V_{OP}$	CW $P_O = 30\text{mW}$		2.0	2.5	V
Oscillation wavelength		$\lambda_L$	CW $P_O = 30\text{mW}$	780	785	790	nm
Radiation angle	Horizontal direction <sup>*1</sup>	$\theta_{//}$	CW $P_O = 30\text{mW}$	8.5	10	11.5	deg.
	Vertical direction <sup>*1</sup>	$\theta_{\perp}$	CW $P_O = 30\text{mW}$	23	25	28	deg.
Differential efficiency		$\eta$	CW $P_O = 3 - 30\text{mW}$	0.8	1.0	1.2	
PIN photo current		$I_P$	CW $P_O = 30\text{mW}$ , $V_R$ (PIN) = 5V		0.3		mA
Reverse current (DC)		$I_R$	$V_R$ (PIN) = 15V			0.1	$\mu\text{A}$
Optical axis accuracy	X direction	$\theta_X$	CW $P_O = 30\text{mW}$	-2.0		+2.0	deg.
	Y direction	$\theta_Y$	CW $P_O = 30\text{mW}$	-3.0		+3.0	deg.

<sup>\*1</sup> The radiation angle is indicated as the full angle at half maximum.

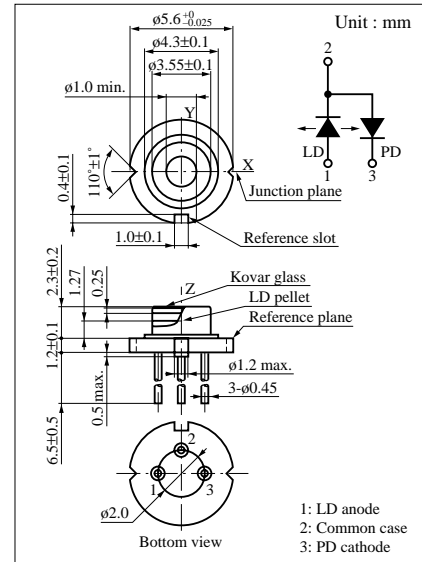

$P_O - I_{OP}$

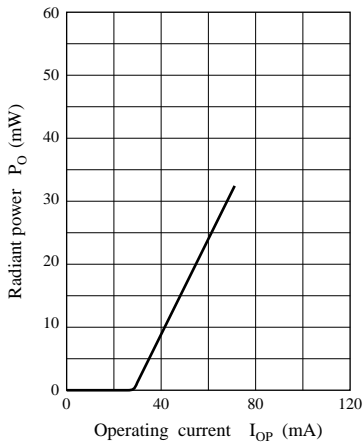

$I - V$

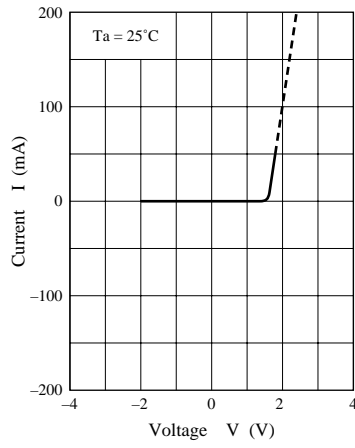

Far field pattern

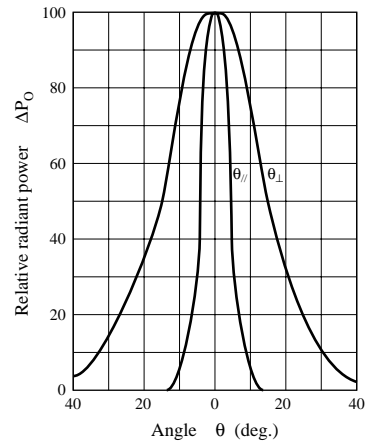

$I_{th} - T_a$

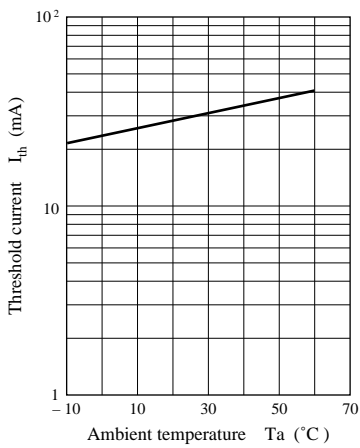

$I_{OP} - T_a$

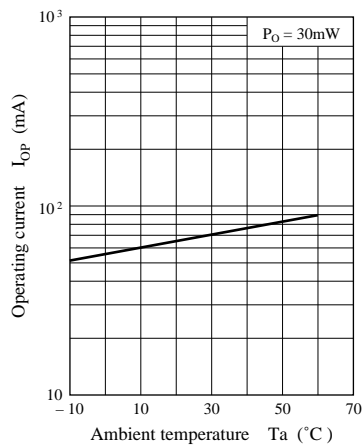

$I_p - T_a$

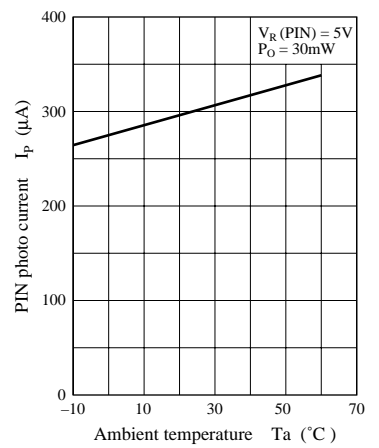

$P_O - T_a$

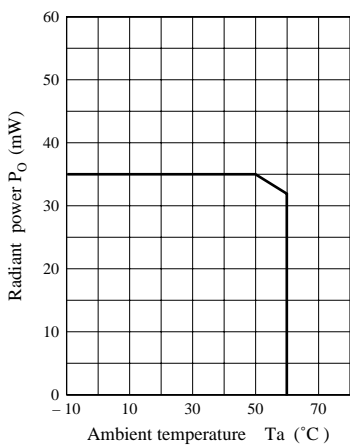

$I_d - T_a$

