

DESCRIPTION The 2SC2786 is designed for use in FM RF amplifier and local oscillator of FM tuner.

- FEATURES**
- High gain bandwidth product ($f_T = 600$ MHz TYP.)
 - Small output capacitance ($C_{ob} = 1.0$ pF TYP.)
 - Low noise figure (NF = 3.0 dB TYP. @100 MHz)

ABSOLUTE MAXIMUM RATINGS

Maximum Temperatures	
Storage Temperature	-55 to +150 °C
Junction Temperature	+150 °C Maximum
Maximum Power Dissipation ($T_a = 25$ °C)	
Total Power Dissipation	250 mW
Maximum Voltages and Currents ($T_a = 25$ °C)	
V_{CBO} Collector to Base Voltage	30 V
V_{CEO} Collector to Emitter Voltage	20 V
V_{EBO} Emitter to Base Voltage	4.0 V
I_C Collector Current	20 mA
I_B Base Current	20 mA

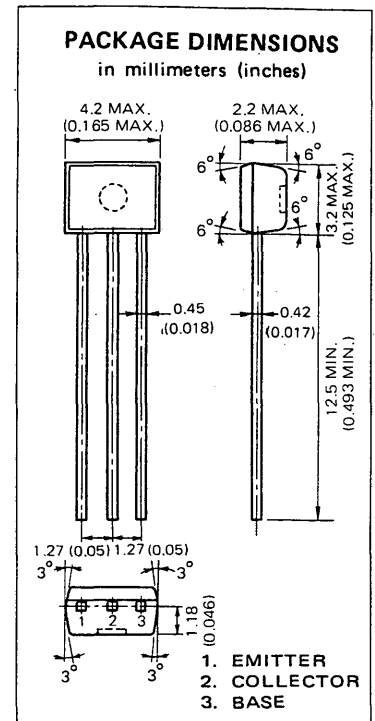

ELECTRICAL CHARACTERISTICS ($T_a = 25$ °C)

SYMBOL	CHARACTERISTIC	MIN.	TYP.	MAX.	UNIT	TEST CONDITIONS
h_{FE}	DC Current Gain	40	90	180	-	$V_{CE}=6.0$ V, $I_C=1.0$ mA
C_{ob}	Output Capacitance		1.0	1.3	pF	$V_{CB}=6.0$ V, $I_E=0$, $f=1.0$ MHz
NF	Noise Figure		3.0	5.0	dB	$V_{CE}=6.0$ V, $I_E=-1.0$ mA, $R_G=50$ Ω $f=100$ MHz, See test circuit
f_T	Gain Bandwidth Product	400	600		MHz	$V_{CE}=6.0$ V, $I_E=-1.0$ mA
G_{pe}	Power Gain	18	22		dB	$V_{CE}=6.0$ V, $I_E=-1.0$ mA, $R_G=50$ Ω $f=100$ MHz, See test circuit
$C_c \cdot r_{b'b}$	Collector to Base Time Constant		12	15	ps	$V_{CE}=6.0$ V, $I_E=-1.0$ mA, $f=31.9$ MHz
I_{CBO}	Collector Cutoff Current			100	nA	$V_{CB}=30$ V, $I_E=0$
I_{EBO}	Emitter Cutoff Current			100	nA	$V_{EB}=4.0$ V, $I_C=0$
V_{BE}	Base to Emitter Voltage		0.72		V	$V_{CE}=6.0$ V, $I_C=1.0$ mA
$V_{CE(sat)}$	Collector Saturation Voltage		0.1	0.3	V	$I_C=10$ mA, $I_B=1.0$ mA

Classification of h_{FE}

Rank	MF	LF	KF
Range	40 - 80	60 - 120	90 - 180

h_{FE} Test Conditions : $V_{CE}=6.0$ V, $I_C=1.0$ mA

TYPICAL CHARACTERISTICS (Ta = 25 °C unless otherwise noted)

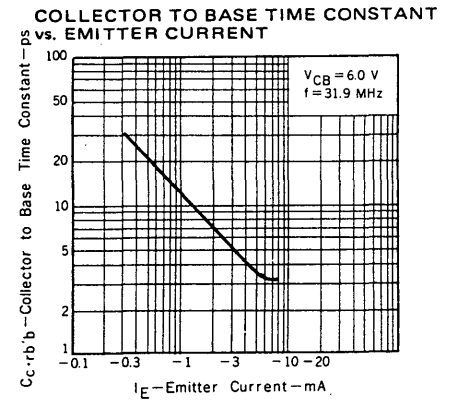
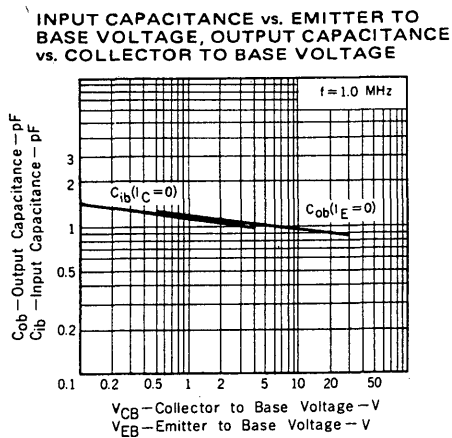
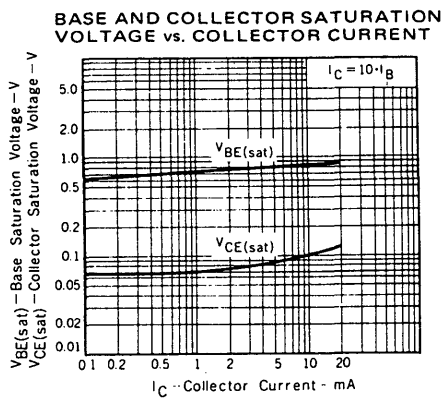
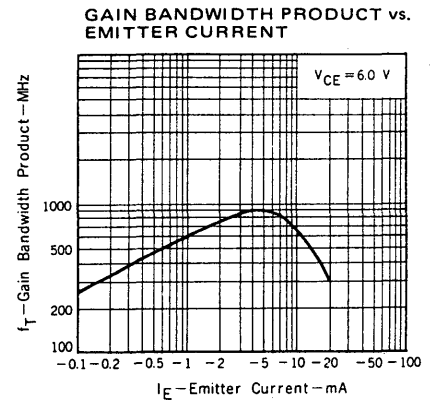
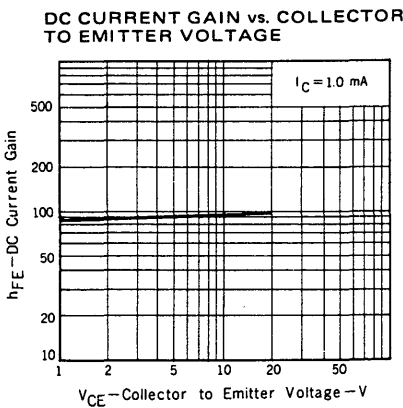
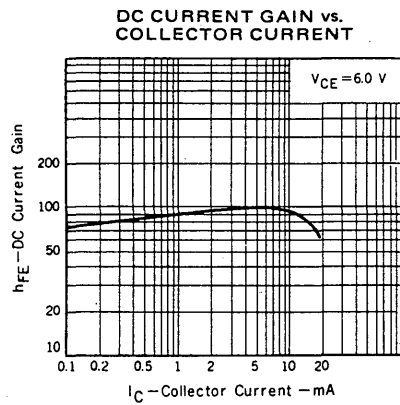
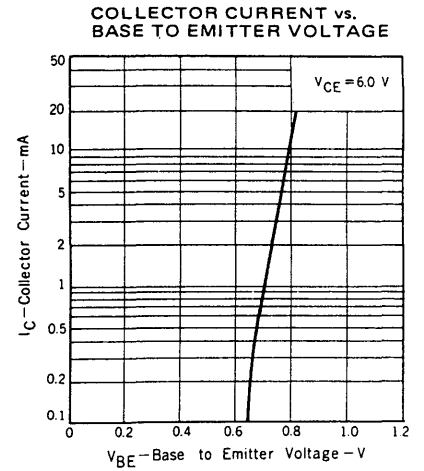
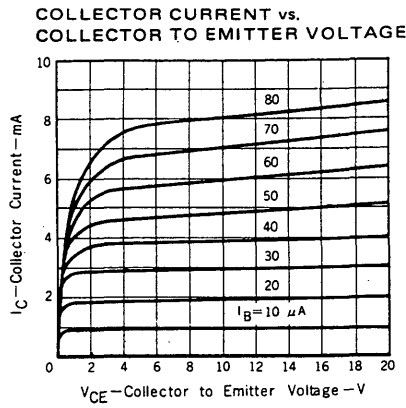
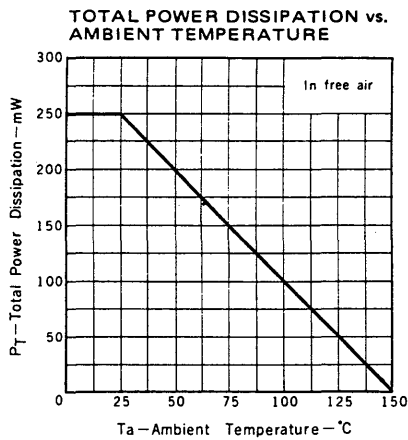

INPUT ADMITTANCE vs. COLLECTOR CURRENT

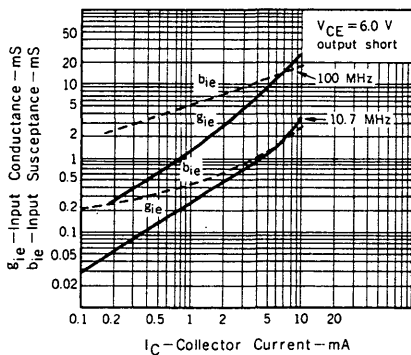

REVERSE TRANSFER ADMITTANCE vs. COLLECTOR CURRENT

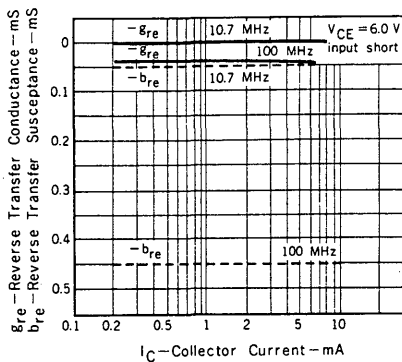

FORWARD TRANSFER ADMITTANCE vs. COLLECTOR CURRENT

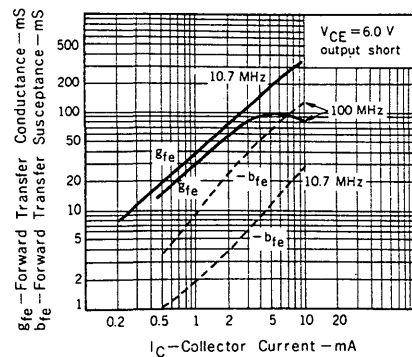

OUTPUT ADMITTANCE vs. COLLECTOR CURRENT

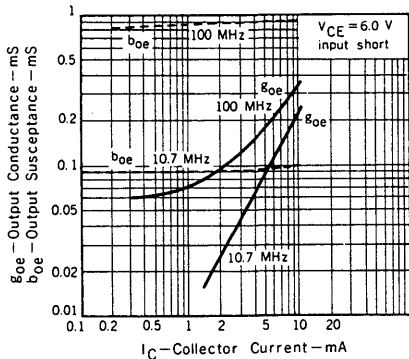

INPUT ADMITTANCE vs. COLLECTOR CURRENT

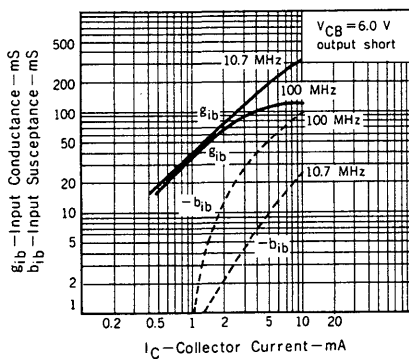

REVERSE TRANSFER ADMITTANCE vs. COLLECTOR CURRENT

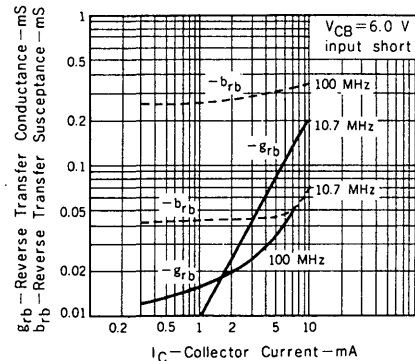

FORWARD TRANSFER ADMITTANCE vs. COLLECTOR CURRENT

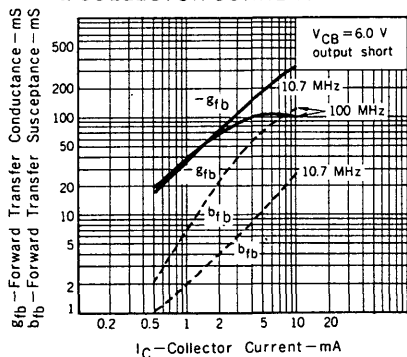

INPUT ADMITTANCE vs. FREQUENCY

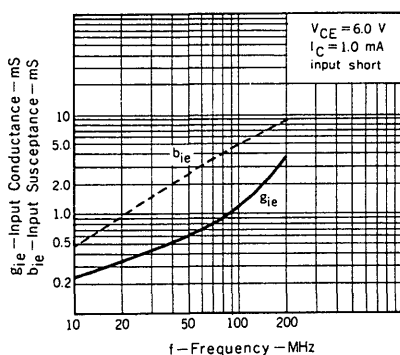

REVERSE TRANSFER ADMITTANCE vs. FREQUENCY

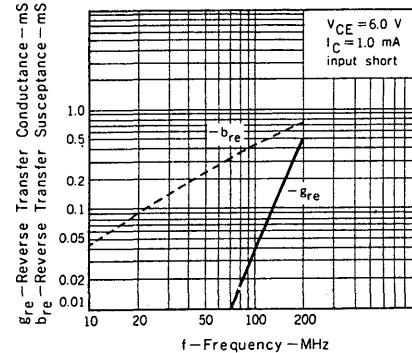

FORWARD TRANSFER ADMITTANCE vs. FREQUENCY

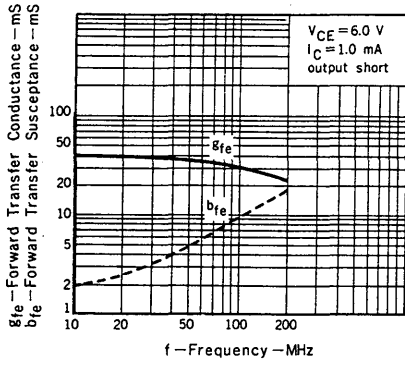

OUTPUT ADMITTANCE vs. FREQUENCY

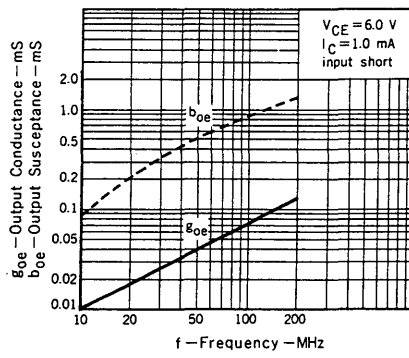

POWER GAIN, NOISE FIGURE vs. EMITTER CURRENT

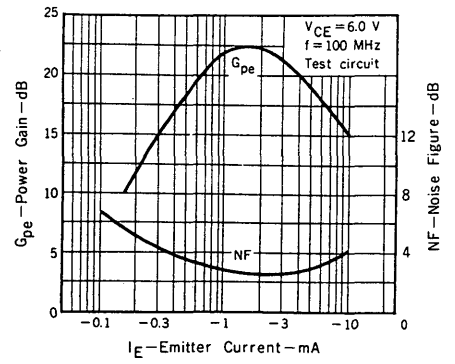

100MHz G_{pe}, NF TEST CIRCUIT

