

**FAIRCHILD**

A Schlumberger Company

**2N6765/2N6766**  
**N-Channel Power MOSFETs,**  
**30 A, 150 V/200 V**

Power And Discrete Division

T-39-13

**Description**

These devices are n-channel, enhancement mode, power MOSFETs designed especially for high power, high speed applications, such as switching power supplies, UPS, AC and DC motor controls, relay and solenoid driver and high energy pulse circuits.

TO-204AE

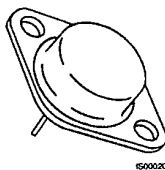

2N6765  
 2N6766

- $V_{GS}$  Rated at  $\pm 20$  V
- Silicon Gate for Fast Switching Speeds
- $I_{DSS}$ ,  $R_{DS(on)}$  Specified at Elevated Temperature
- Rugged
- Low Drive Requirements
- Ease of Paralleling

**Maximum Ratings**

| Symbol         | Characteristic                                                            | Rating<br>2N6766 | Rating<br>2N6765 | Unit               |
|----------------|---------------------------------------------------------------------------|------------------|------------------|--------------------|
| $V_{DSS}$      | Drain to Source Voltage                                                   | 200              | 150              | V                  |
| $V_{DGR}$      | Drain to Gate Voltage<br>$R_{GS} = 1 \text{ M}\Omega$                     | 200              | 150              | V                  |
| $V_{GS}$       | Gate to Source Voltage                                                    | $\pm 20$         | $\pm 20$         | V                  |
| $T_J, T_{stg}$ | Operating Junction and Storage Temperatures                               | -55 to +150      | -55 to +150      | $^{\circ}\text{C}$ |
| $T_L$          | Maximum Lead Temperature for Soldering Purposes, 1/16" From Case for 10 s | 300              | 300              | $^{\circ}\text{C}$ |

**Maximum On-State Characteristics**

|              |                                                                                                        |          |          |          |
|--------------|--------------------------------------------------------------------------------------------------------|----------|----------|----------|
| $R_{DS(on)}$ | Static Drain-to-Source On Resistance                                                                   | 0.085    | 0.12     | $\Omega$ |
| $I_D$        | Drain Current<br>Continuous at $T_C = 25^{\circ}\text{C}$<br>Continuous at $T_C = 100^{\circ}\text{C}$ | 30<br>19 | 25<br>16 | A        |
| $I_{DM}$     | Pulsed                                                                                                 | $60^2$   | $50^2$   |          |

**Maximum Thermal Characteristics**

|                 |                                                                                            |           |           |                             |
|-----------------|--------------------------------------------------------------------------------------------|-----------|-----------|-----------------------------|
| $R_{\theta JC}$ | Thermal Resistance, Junction to Case                                                       | 0.83      | 0.83      | $^{\circ}\text{C}/\text{W}$ |
| $P_D$           | Total Power Dissipation<br>at $T_C = 25^{\circ}\text{C}$<br>at $T_C = 100^{\circ}\text{C}$ | 150<br>60 | 150<br>60 | W                           |
|                 | Linear Derating Factor                                                                     | 1.2       | 1.2       | $\text{W}/^{\circ}\text{C}$ |

**Notes**

All values are JEDEC registered except as noted. For information concerning connection diagram and package outline, refer to Section 7.

## 2N6765/2N6766

T-39-13

Electrical Characteristics ( $T_C = 25^\circ\text{C}$  unless otherwise noted)

| Symbol                                                                                | Characteristic                                 | Min              | Max              | Unit           | Test Conditions                                                                                                                                                              |
|---------------------------------------------------------------------------------------|------------------------------------------------|------------------|------------------|----------------|------------------------------------------------------------------------------------------------------------------------------------------------------------------------------|
| <b>Off Characteristics</b>                                                            |                                                |                  |                  |                |                                                                                                                                                                              |
| $V_{(BR)DSS}$                                                                         | Drain Source Breakdown Voltage                 |                  |                  | V              | $V_{GS} = 0\text{ V}$ , $I_D = 1.0\text{ mA}$                                                                                                                                |
|                                                                                       | 2N6766                                         | 200 <sup>2</sup> |                  |                |                                                                                                                                                                              |
|                                                                                       | 2N6765                                         | 150 <sup>2</sup> |                  |                |                                                                                                                                                                              |
| $I_{DSS}$                                                                             | Zero Gate Voltage Drain Current                |                  | 1                | mA             | $V_{DS} = \text{Rated } V_{DSS}$ , $V_{GS} = 0\text{ V}$<br>$V_{GS} = 0\text{ V}$ , $T_C = 125^\circ\text{C}$                                                                |
|                                                                                       |                                                |                  | 4                |                |                                                                                                                                                                              |
| $I_{GSS}$                                                                             | Gate-Body Leakage Current                      |                  | $\pm 100$        | nA             | $V_{GS} = \pm 20\text{ V}$ , $V_{DS} = 0\text{ V}$                                                                                                                           |
| <b>On Characteristics</b>                                                             |                                                |                  |                  |                |                                                                                                                                                                              |
| $V_{GS(th)}$                                                                          | Gate Threshold Voltage                         | 2.0              | 4.0              | V              | $I_D = 1.0\text{ mA}$ , $V_{DS} = V_{GS}$                                                                                                                                    |
| $R_{DS(on)}$                                                                          | Static Drain-Source On-Resistance <sup>1</sup> |                  |                  | $\Omega$       | $V_{GS} = 10\text{ V}$ ,<br>$I_D = 19\text{ A}$<br>$I_D = 16\text{ A}$<br>$I_D = 19\text{ A}$ , $T_C = 125^\circ\text{C}$<br>$I_D = 16\text{ A}$ , $T_C = 125^\circ\text{C}$ |
|                                                                                       | 2N6766                                         |                  | 0.085            |                |                                                                                                                                                                              |
|                                                                                       | 2N6765                                         |                  | 0.12             |                |                                                                                                                                                                              |
|                                                                                       | 2N6766                                         |                  | 0.153            |                |                                                                                                                                                                              |
|                                                                                       | 2N6765                                         |                  | 0.216            |                |                                                                                                                                                                              |
| $V_{DS(on)}$                                                                          | Drain-Source On-Voltage <sup>1</sup>           |                  |                  | V              | $V_{GS} = 10\text{ V}$<br>$I_D = 30\text{ A}$<br>$I_D = 25\text{ A}$                                                                                                         |
|                                                                                       | 2N6766                                         |                  | 2.7              |                |                                                                                                                                                                              |
|                                                                                       | 2N6765                                         |                  | 3.0              |                |                                                                                                                                                                              |
| $g_{fs}$                                                                              | Forward Transconductance <sup>1</sup>          | 9.0              | 27               | S ( $\Omega$ ) | $V_{DS} = 15\text{ V}$ , $I_D = 19\text{ A}$                                                                                                                                 |
| <b>Dynamic Characteristics</b>                                                        |                                                |                  |                  |                |                                                                                                                                                                              |
| $C_{iss}$                                                                             | Input Capacitance                              | 1000             | 3000             | pF             | $V_{DS} = 25\text{ V}$ , $V_{GS} = 0\text{ V}$<br>$f = 1.0\text{ MHz}$                                                                                                       |
| $C_{oss}$                                                                             | Output Capacitance                             | 450              | 1200             | pF             |                                                                                                                                                                              |
| $C_{rss}$                                                                             | Reverse Transfer Capacitance                   | 150              | 500              | pF             |                                                                                                                                                                              |
| <b>Switching Characteristics (<math>T_C = 25^\circ\text{C}</math>, Figures 9, 10)</b> |                                                |                  |                  |                |                                                                                                                                                                              |
| $t_{d(on)}$                                                                           | Turn-On Delay Time                             |                  | 35               | ns             | $V_{DD} = 95\text{ V}$ , $I_D = 19\text{ A}$<br>$V_{GS} = 10\text{ V}$ , $R_{GEN} = 4.7\ \Omega$<br>$R_{GS} = 4.7\ \Omega$                                                   |
| $t_r$                                                                                 | Rise Time                                      |                  | 100              | ns             |                                                                                                                                                                              |
| $t_{d(off)}$                                                                          | Turn-Off Delay Time                            |                  | 125              | ns             |                                                                                                                                                                              |
| $t_f$                                                                                 | Fall Time                                      |                  | 100              | ns             |                                                                                                                                                                              |
| $Q_g$                                                                                 | Total Gate Charge                              |                  | 120 <sup>2</sup> | nC             | $V_{GS} = 10\text{ V}$ , $I_D = 38\text{ A}$<br>$V_{DD} = 100\text{ V}$                                                                                                      |

**Electrical Characteristics (Cont.)** ( $T_C = 25^\circ\text{C}$  unless otherwise noted)

| Symbol                                    | Characteristic                                | Min         | Typ     | Max              | Unit          | Test Conditions                                                                                            |
|-------------------------------------------|-----------------------------------------------|-------------|---------|------------------|---------------|------------------------------------------------------------------------------------------------------------|
| <b>Source-Drain Diode Characteristics</b> |                                               |             |         |                  |               |                                                                                                            |
| $I_S$                                     | Continuous Source Current<br>2N6766<br>2N6765 |             |         | 30<br>25         | A             |                                                                                                            |
| $I_{SM}$                                  | Pulsed Source Current<br>2N6766<br>2N6765     |             |         | $60^2$<br>$50^2$ | A             |                                                                                                            |
| $V_{SD}$                                  | Diode Forward Voltage<br>2N6766<br>2N6765     | 0.9<br>0.85 |         | 1.8<br>1.7       | V             | $V_{GS} = 0\text{ V}$<br>$I_S = 30\text{ A}$<br>$I_S = 25\text{ A}$                                        |
| $t_{rr}$                                  | Reverse Recovery Time                         |             | $500^2$ |                  | ns            | $V_{GS} = 0\text{ V}$ , $T_J = 150^\circ\text{C}$<br>$I_F = I_{SM}$ , $di_F/dt = 100\text{ A}/\mu\text{s}$ |
| $Q_{RR}$                                  | Reverse Recovery Charge                       |             | $10^2$  |                  | $\mu\text{C}$ | $V_{GS} = 0\text{ V}$ , $T_J = 150^\circ\text{C}$<br>$I_F = I_{SM}$ , $di_F/dt = 100\text{ A}/\mu\text{s}$ |

**Notes**

1. Pulse test: Pulse width  $\leq 300\ \mu\text{s}$ , Duty cycle  $\leq 2\%$
2. Non-JEDEC registered value.

**Typical Performance Curves**

**Figure 1 Output Characteristics**

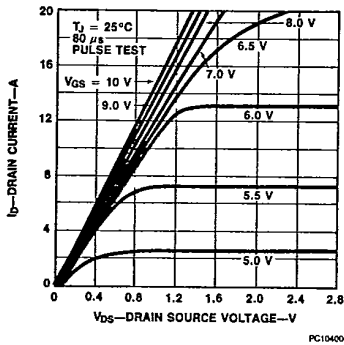

**Figure 2 Static Drain to Source On-Resistance vs Drain Current**

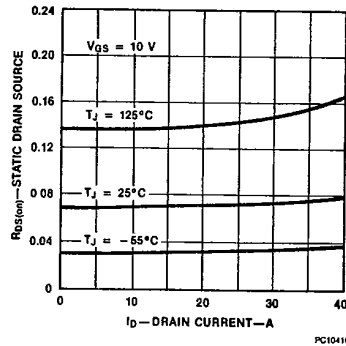

Typical Performance Curves (Cont.)

Figure 3 Transfer Characteristics

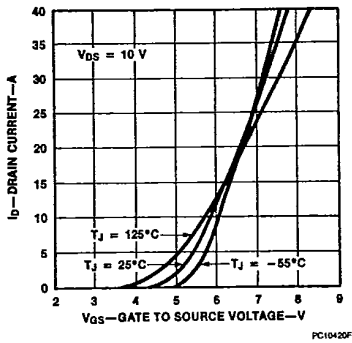

Figure 4 Temperature Variation of Gate to Source Threshold Voltage

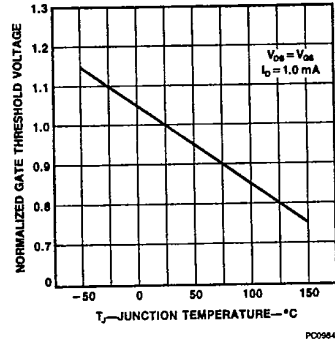

Figure 5 Capacitance vs Drain to Source Voltage

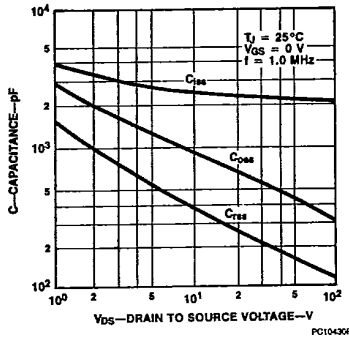

Figure 6 Gate to Source Voltage vs Total Gate Charge

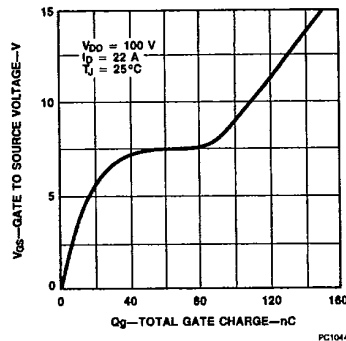

Figure 7 Forward Biased Safe Operating Area

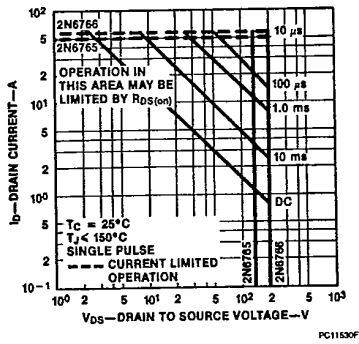
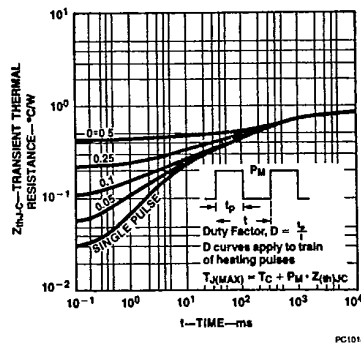

Figure 8 Transient Thermal Resistance vs Time



Typical Electrical Characteristics

Figure 9 Switching Test Circuit

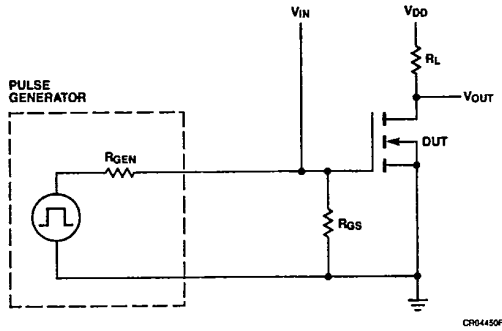
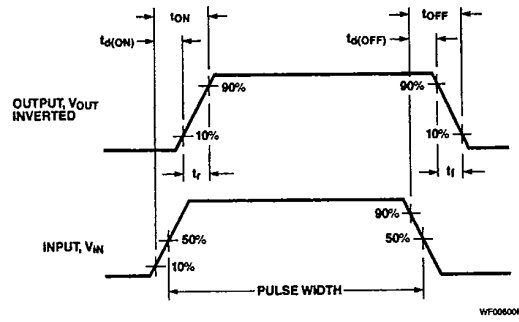

Figure 10 Switching Waveforms



This datasheet has been downloaded from:

[www.DatasheetCatalog.com](http://www.DatasheetCatalog.com)

Datasheets for electronic components.