

C/A-5001X SINGLE DIGIT DISPLAY

Shape	Part No.		Chip		Wave Length λ_p (nm)	Electro-Optical Characteristics			Fig. No.
	Common Cathode	Common Anode	Raw Material	Emitted Color		Vf(V)20mA		Iv(ucd)10mA	
						Typ.	Max.	Typ.	
	C-5001H	A-5001H	GaP	Red	700	21.0	23.0	8000	D24
	C-5001E	A-5001E	GaAsP/GaP	Hi. effi Red	635	20.0	22.0	30000	
	C-5001G	A-5001G	GaP	Green	565	21.0	23.0	30000	
	C-5001Y	A-5001Y	GaAsP/GaP	Yellow	585	21.0	23.0	30000	
	C-5001SR	A-5001SR	GaAlAs	Super Red	660	18.0	20.0	60000	

Fig.D24



C-5001X

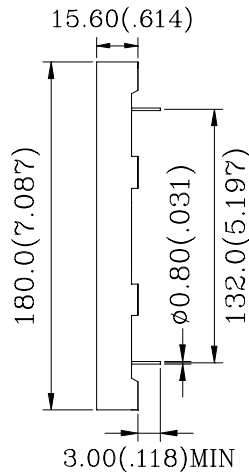
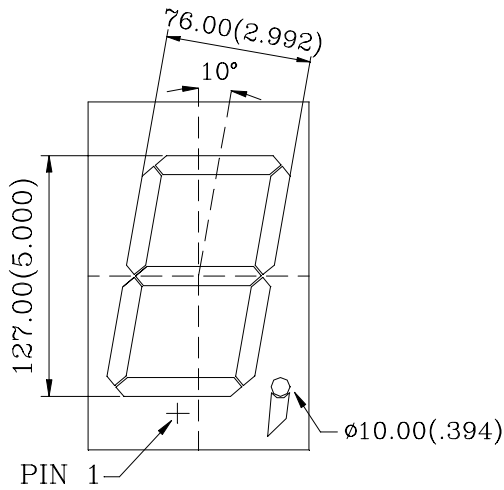
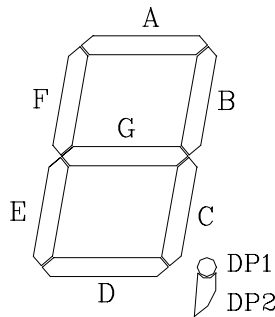
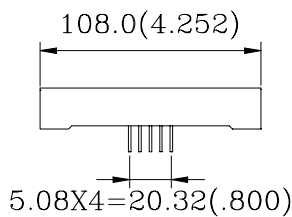
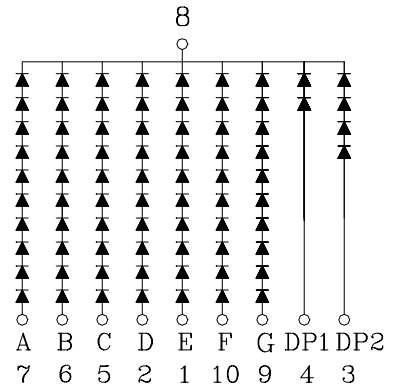

A-5001X

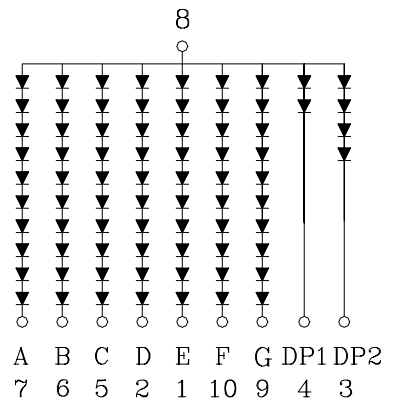

1.All dimension are in millimeters (inches).
2.Tolerance is ± 0.25 mm (0.01") unless otherwise specified.

This datasheet has been downloaded from:

www.DatasheetCatalog.com

Datasheets for electronic components.