

NPN Silicon RF Transistor

BF 599

- Common emitter IF/RF amplifier
- Low feedback capacitance due to shield diffusion

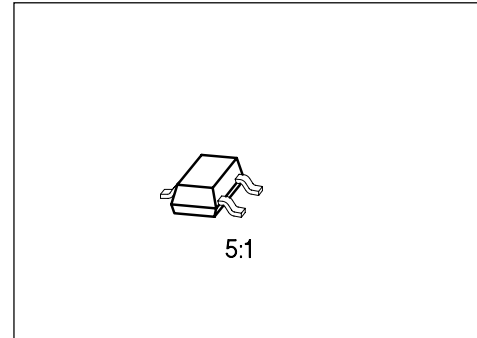

Type	Marking	Ordering Code (tape and reel)	Pin Configuration			Package ¹⁾
			1	2	3	
BF 599	NB	Q62702-F979	B	E	C	SOT-23

Maximum Ratings

Parameter	Symbol	Values	Unit
Collector-emitter voltage	V_{CE0}	25	V
Collector-base voltage	V_{CB0}	40	
Emitter-base voltage	V_{EB0}	4	
Collector current	I_C	25	mA
Base current	I_B	5	
Total power dissipation, $T_A \leq 25\text{ °C}$	P_{tot}	280	mW
Junction temperature	T_j	150	°C
Storage temperature range	T_{stg}	- 65 ... + 150	

Thermal Resistance

Junction - ambient ²⁾	$R_{th JA}$	≤ 450	K/W
----------------------------------	-------------	------------	-----

¹⁾ For detailed information see chapter Package Outlines.

²⁾ Package mounted on alumina 15 mm × 16.7 mm × 0.7 mm.

Electrical Characteristics

at $T_A = 25\text{ °C}$, unless otherwise specified.

Parameter	Symbol	Values			Unit
		min.	typ.	max.	

DC Characteristics

Collector-emitter breakdown voltage $I_C = 1\text{ mA}, I_B = 0$	$V_{(BR)CE0}$	25	–	–	V
Collector cutoff current $V_{CB} = 20\text{ V}, I_E = 0$	I_{CB0}	–	–	100	nA
DC current gain $I_C = 7\text{ mA}, V_{CE} = 10\text{ V}$	h_{FE}	38	70	–	–
Collector-emitter saturation voltage $I_C = 10\text{ mA}, I_B = 1\text{ mA}$	$V_{CE\text{ sat}}$	–	0.15	–	V
Base-emitter voltage $I_C = 7\text{ mA}, V_{CE} = 10\text{ V}$	V_{BE}	–	0.78	–	

AC Characteristics

Transition frequency $I_C = 5\text{ mA}, V_{CE} = 10\text{ V}, f = 100\text{ MHz}$	f_T	–	550	–	MHz
Collector-base capacitance $V_{CB} = 10\text{ V}, V_{BE} = 0\text{ V}, f = 1\text{ MHz}$	C_{cb}	–	0.35	–	pF
Collector-emitter capacitance $V_{CE} = 10\text{ V}, V_{BE} = 0\text{ V}, f = 1\text{ MHz}$	C_{ce}	–	0.68	–	
Optimum power gain $I_C = 7\text{ mA}, V_{CE} = 10\text{ V}, f = 35\text{ MHz}$	$G_{pe\text{ opt}}$	–	43	–	dB
Forward transfer admittance $I_C = 7\text{ mA}, V_{CE} = 10\text{ V}, f = 35\text{ MHz}$	$ y_{21e} $	–	175	–	mS

Total power dissipation $P_{tot} = f(T_A)$

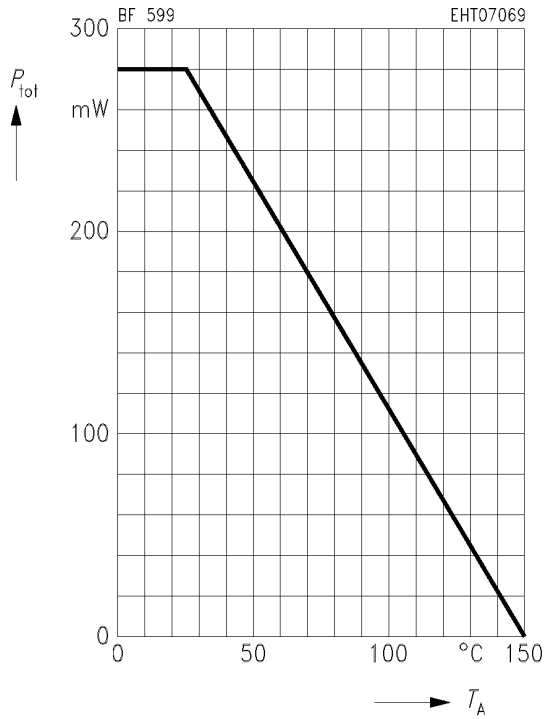

DC current gain $h_{FE} = f(I_C)$

$V_{CE} = 10\text{ V}$

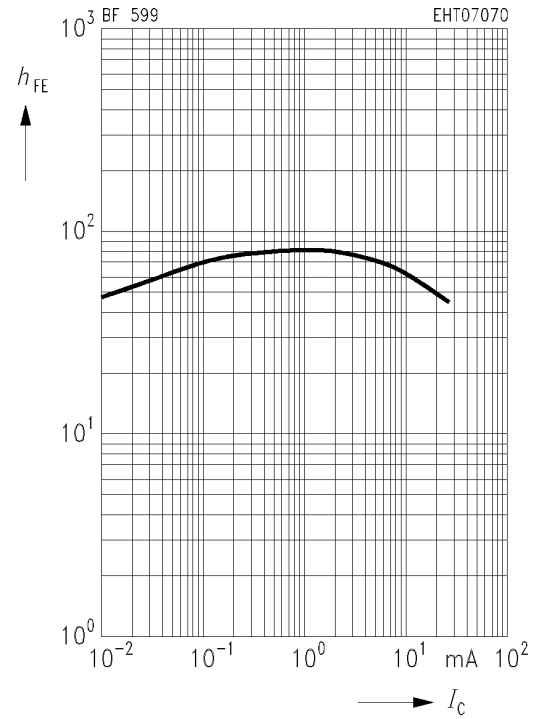

Collector current $I_C = f(V_{BE})$

$V_{CE} = 10\text{ V}$

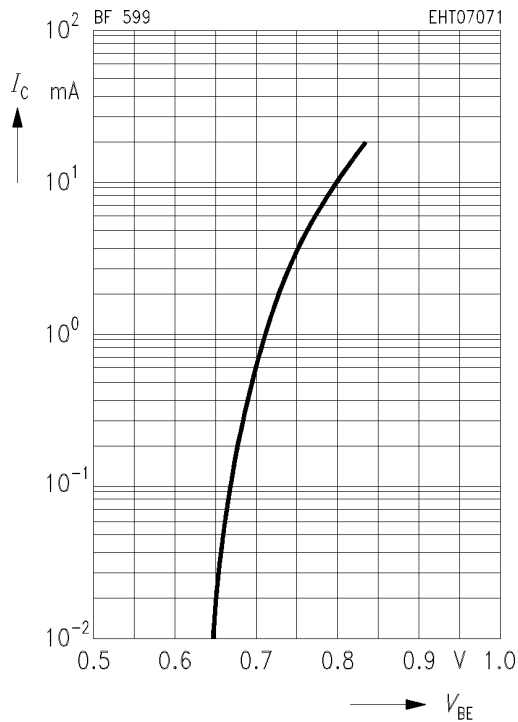

Collector-emitter saturation voltage $I_C = f(V_{CEsat})$

$h_{FE} = 10$

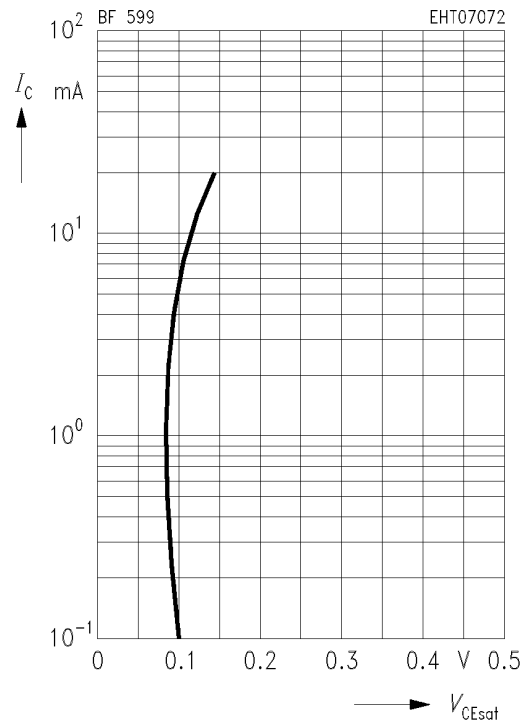

Collector cutoff current $I_{CB0} = f(T_A)$

$V_{CB} = 20\text{ V}$

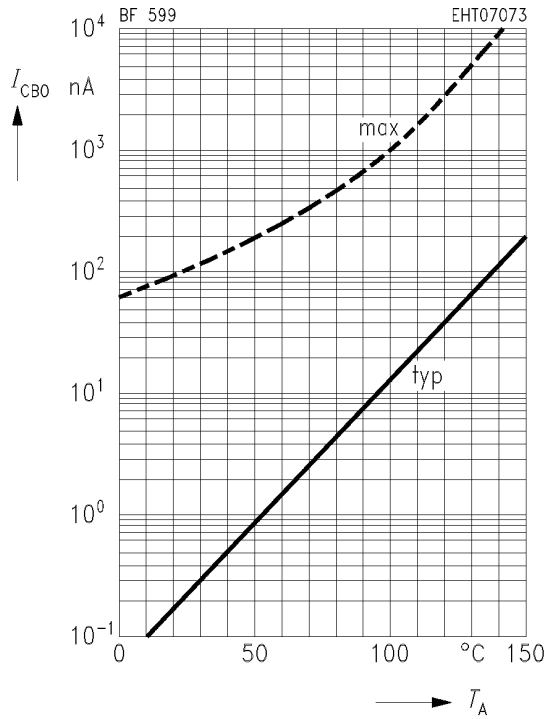

Transition frequency $f_T = f(I_C)$

$f = 100\text{ MHz}$

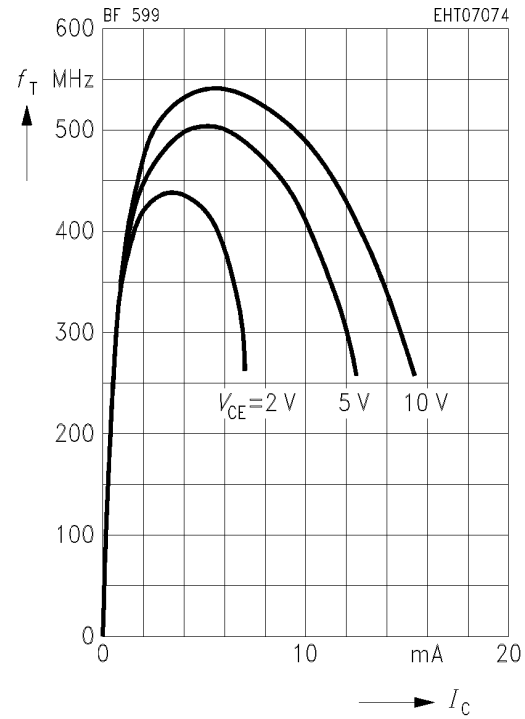

Collector-base capacitance $C_{cb} = f(V_{CB})$

$f = 1\text{ MHz}$

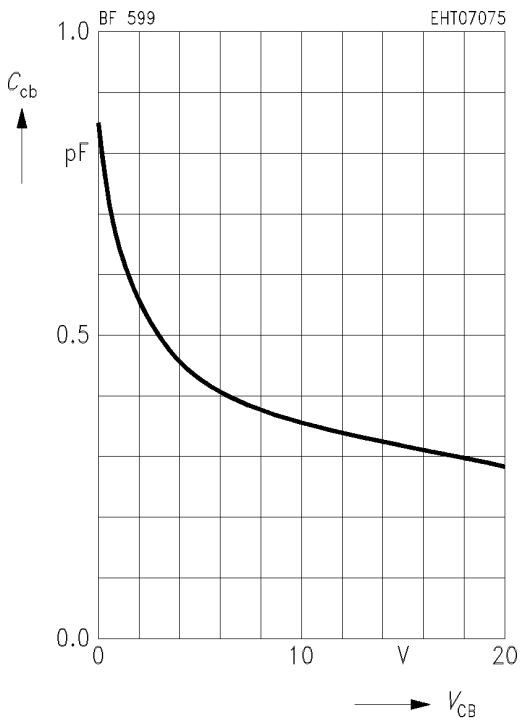

Forward transfer admittance $|y_{21e}| = f(I_C)$

