

SILICON TRANSISTOR

2SA1608

HIGH FREQUENCY AMPLIFIER AND SWITCHING PNP SILICON EPITAXIAL TRANSISTOR

PACKAGE DIMENSIONS

in millimeters

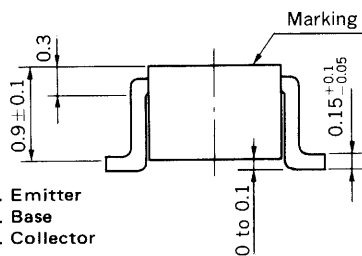
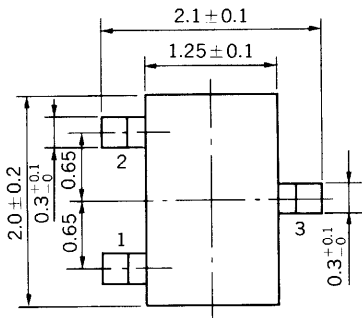

- 1. Emitter
- 2. Base
- 3. Collector

FEATURES

- High f_T : $f_T = 400$ MHz
- Complementary to 2SC3739

ABSOLUTE MAXIMUM RATINGS

Maximum Voltages and Current ($T_a = 25^\circ\text{C}$)

Collector to Base Voltage	V_{CB0}	-60	V
Collector to Emitter Voltage	V_{CEO}	-40	V
Emitter to Base Voltage	V_{EBO}	-5.0	V
Collector Current (DC)	I_C	-500	mA

Maximum Power Dissipation

Total power Dissipation at 25°C Ambient Temperature	P_T	150	mW
--	-------	-----	----

Maximum Temperatures

Junction Temperature	T_j	150	$^\circ\text{C}$
Storage Temperature Range	T_{stg}	-55 to +150	$^\circ\text{C}$

ELECTRICAL CHARACTERISTICS ($T_a = 25^\circ\text{C}$)

CHARACTERISTIC	SYMBOL	MIN.	TYP.	MAX.	UNIT	TEST CONDITIONS
Collector Cutoff Current	I_{CBO}			-100	nA	$V_{CB} = -40\text{ V}, I_E = 0$
Emitter Cutoff Current	I_{EBO}			-100	nA	$V_{EB} = -4.0\text{ V}, I_C = 0$
DC Current Gain	h_{FE1}^*	75	140	300		$V_{CE} = -2.0\text{ V}, I_C = -150\text{ mA}$
DC Current Gain	h_{FE2}^*	20	50			$V_{CE} = -2.0\text{ V}, I_C = -150\text{ mA}$
Collector Saturation Voltage	$V_{CE(sat)}^*$		-0.45	-0.75	V	$I_C = -500\text{ mA}, I_B = -50\text{ mA}$
Base Saturation Voltage	$V_{BE(sat)}^*$		-1.0	-1.30	V	$I_C = -500\text{ mA}, I_B = -50\text{ mA}$
Gain Bandwidth Product	f_T	150	400		MHz	$V_{CE} = -10\text{ V}, I_E = 20\text{ mA}$
Output Capacitance	C_{ob}		5.0	8.0	pF	$V_{CB} = -10\text{ V}, I_E = 0, f = 1.0\text{ MHz}$
Turn-on Time	t_{on}		25		ns	$V_{CC} = -30\text{ V}$
Storage Time	t_{stg}		70		ns	$I_C = 150\text{ mA}$
Turn-off Time	t_{off}		100		ns	$I_{B1} = -I_{B2} = 15\text{ mA}$

* Pulsed: $PW \leq 350\ \mu\text{s}$, Duty Cycle $\leq 2\%$

h_{FE} Classification

Making	Y12	Y13	Y14
h_{FE1}	75 to 150	100 to 200	150 to 300

SWITCHING TIME TEST CIRCUIT

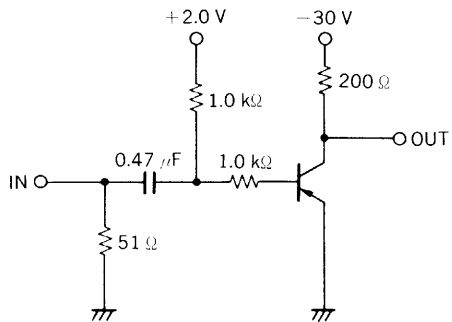

t_{on} SWITCHING

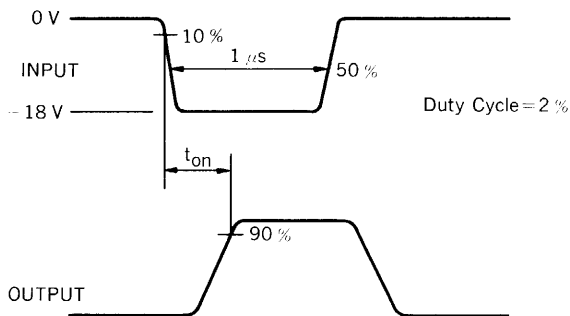

VOLTAGE WAVEFORMS

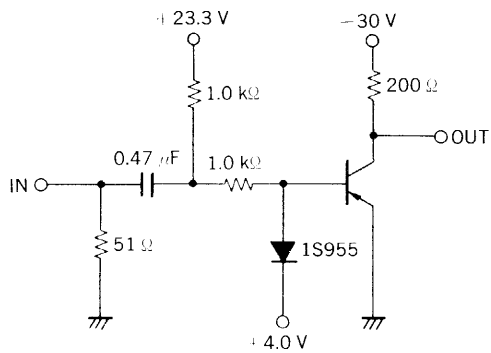

t_{stg} , t_{off} SWITCHING

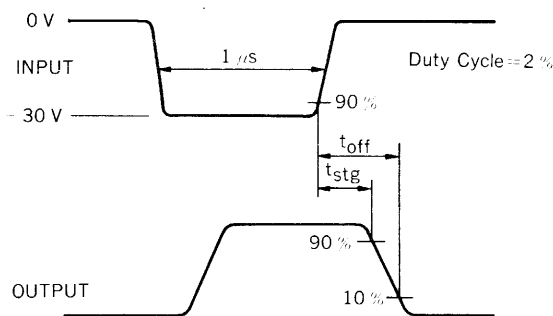

VOLTAGE WAVEFORMS

TYPICAL CHARACTERISTICS ($T_a = 25^\circ\text{C}$)

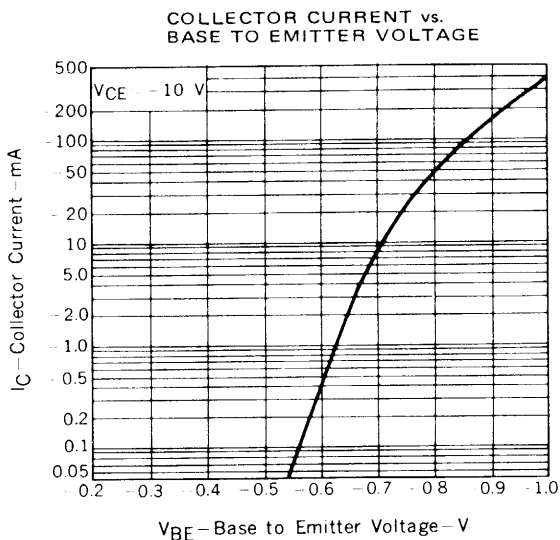
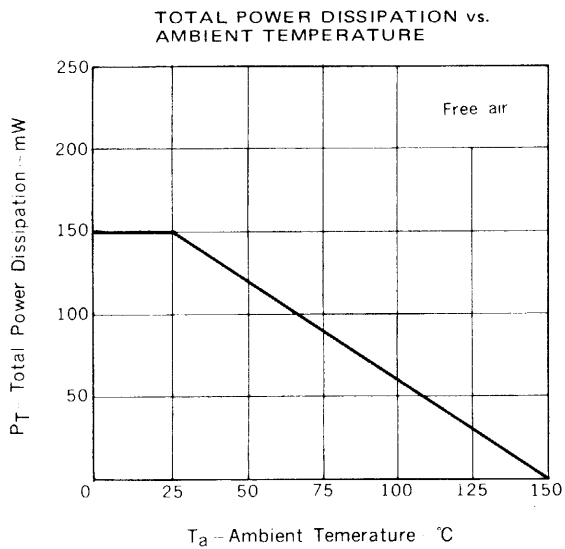

COLLECTOR CURRENT vs. COLLECTOR TO EMITTER VOLTAGE

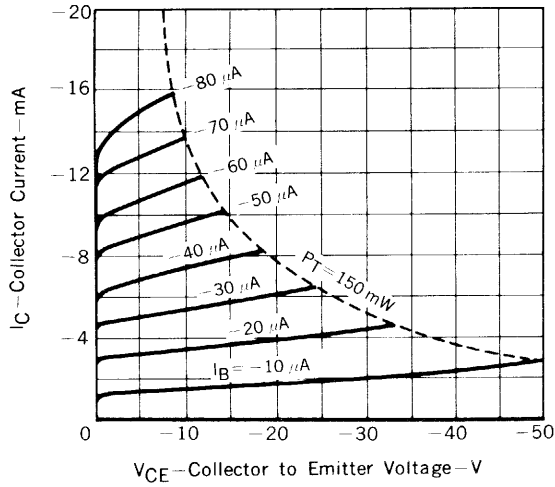

BASE AND COLLECTOR SATURATION VOLTAGE vs. COLLECTOR CURRENT

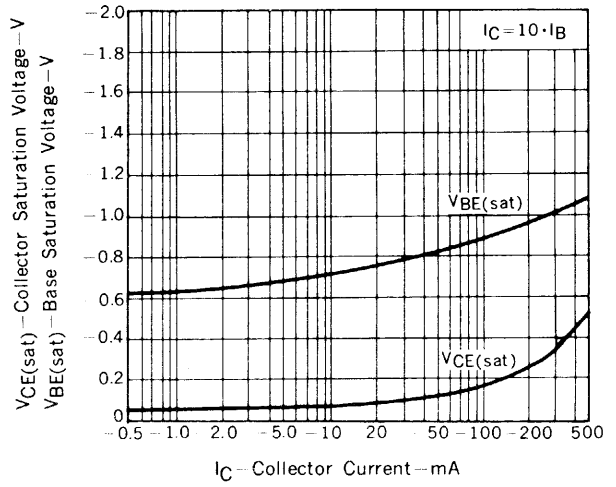

DC CURRENT GAIN vs. COLLECTOR CURRENT

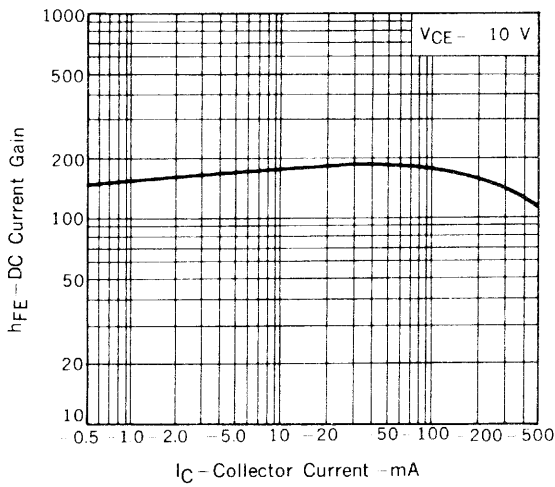

GAIN BANDWIDTH PRODUCT vs. EMITTER CURRENT

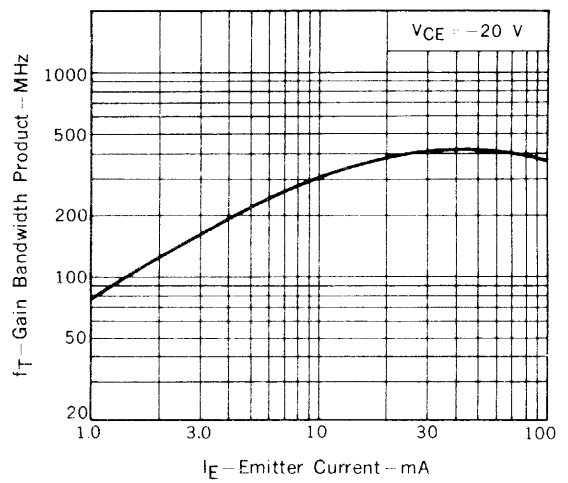

INPUT AND OUTPUT CAPACITANCE vs. REVERSE VOLTAGE

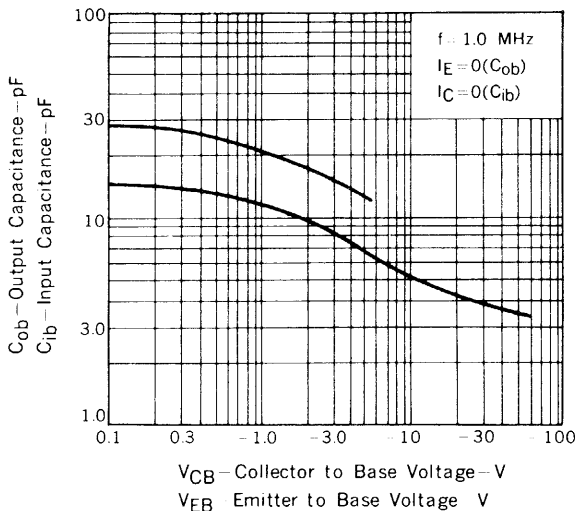

DELAY TIME vs. COLLECTOR CURRENT

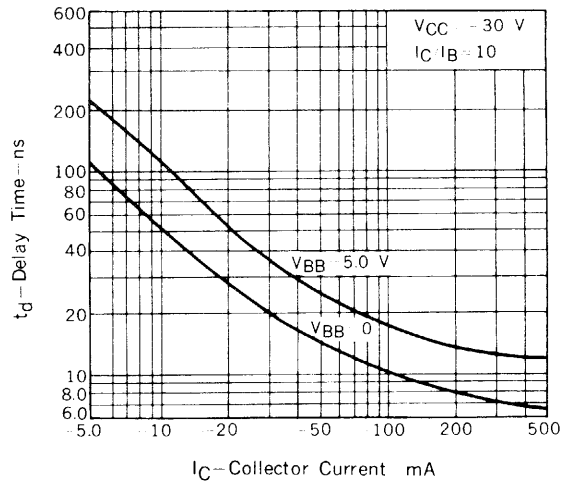

RISE TIME vs. COLLECTOR CURRENT

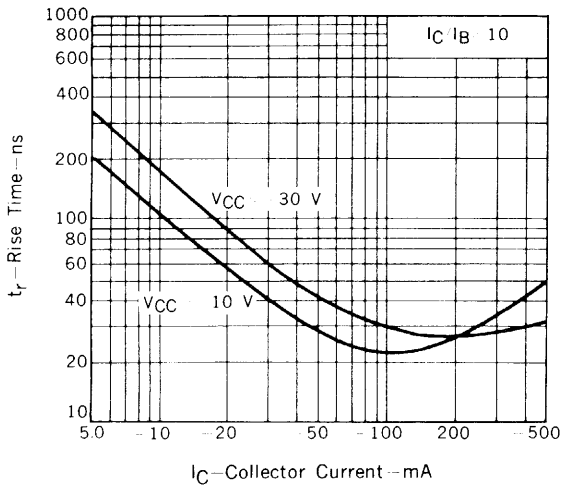

STORAGE TIME vs. COLLECTOR CURRENT

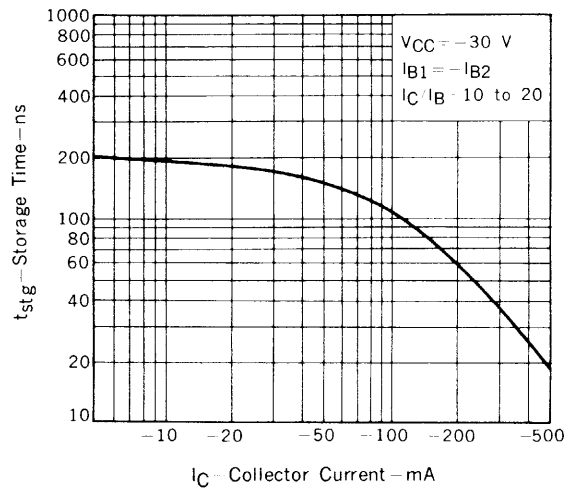

FALL TIME vs. COLLECTOR CURRENT

