

REV. Status

PRELIMINARY  
10/23/00 LL

PRELIMINARY 1  
SIDE VIEW  
REDRAWN.  
10/27/00 LL

PRELIMINARY 2  
CHANGED  
HEIGHT  
12/20/00 LL

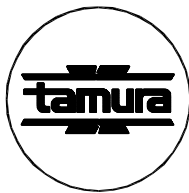

# 10/100 Base-T LAN Magnetic Module Single Port, 16 pin SOIC

MODEL NUMBER  
**TTC-8100**

- Complies with IEEE 802.3 Standard
- Surface Mount Device withstands IR reflow profile process
- Operating temperature: 0°C to 70°C
- Enhanced Common Mode Attenuation

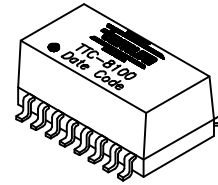

| Electrical Specification @ 25°C |                      |        |        |               |                    |              |              |
|---------------------------------|----------------------|--------|--------|---------------|--------------------|--------------|--------------|
| Insertion Loss (dB Max)         | Return Loss (dB Min) |        |        | CMRR (dB Min) | Crosstalk (dB Min) | OCL (μH Min) | Hipot (Vrms) |
| 0.1-100 MHz                     | 0.1-30 MHz           | 60 MHz | 80 MHz | 0.1-100 MHz   | 0.1-100 MHz        | 8mA DC Bias  | 1 minute     |
| -1                              | -18                  | -14    | -12    | -35           | -35                | 350          | 1500         |

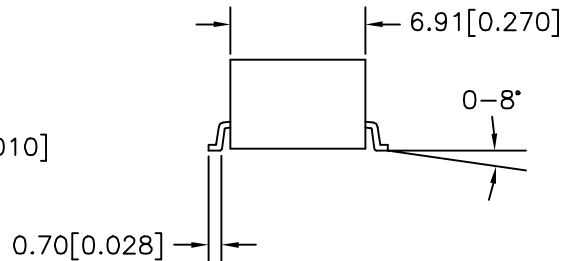
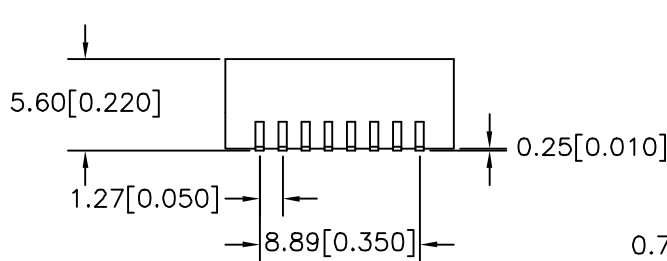
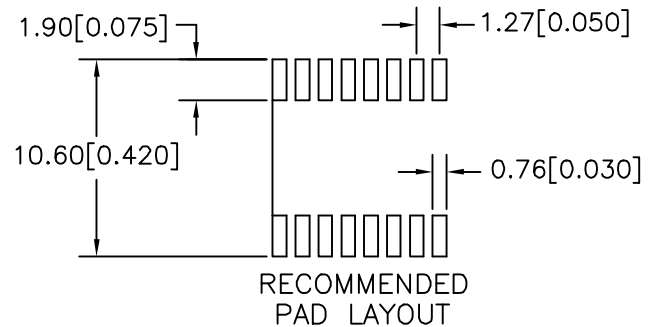
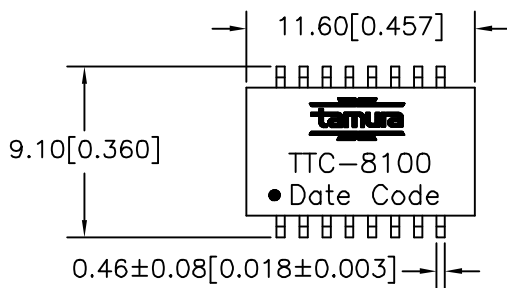
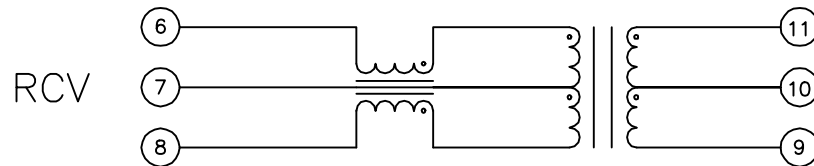
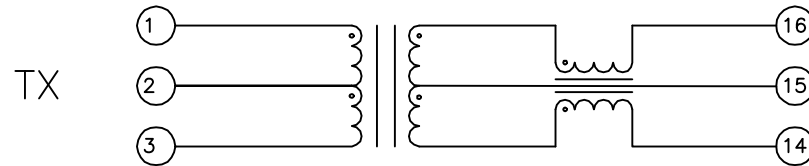

PREPARED BY:

D. Rund

ENGINEER:

L. Le

QUALITY CONTROL:

-----

APPROVED:

J. Coleman

NOTE: Unless otherwise specified, all dimensions are mm[in] with tolerance of ±0.25[0.010]

DWG CONTROL NO. P-A1-12622  
ACAD\TTC\A1126221.DWG

REV PR2

10/100 Base-X LAN Magnetic Module  
Single Port, 16 pin SOIC

**TAMURA CORPORATION OF AMERICA**  
43352 BUSINESS PARK DRIVE, TEMECULA, CA. 92590-6624  
(909) 699-1270 FAX 9096769482

**TTC-8100**

MODEL SPECIFICATION

DIM: mm(in) SCL: none SH: 1 OF 1

PROPRIETARY NOTICE: THIS DRAWING PRINT OR DOCUMENT AND SUBJECT MATTER DISCLOSED HEREIN ARE PROPRIETARY ITEMS TO WHICH TAMURA RETAINS THE EXCLUSIVE RIGHT OF DISSEMINATION, REPRODUCTION, MANUFACTURE AND SALE. THIS DRAWING, PRINT OR DOCUMENT IS SUBMITTED IN CONFIDENCE FOR CONSIDERATION BY THE RECIPIENT ALONE UNLESS PERMISSION FOR FURTHER DISCLOSURE IS EXPRESSLY GRANTED IN WRITING.