

The RF MOSFET Line
RF Power
Field Effect Transistors
N-Channel Enhancement-Mode Lateral
MOSFETs

- High Gain, Rugged Device
- Broadband Performance from HF to 1 GHz
- Bottom Side Source Eliminates DC Isolators, Reducing Common Mode Inductances

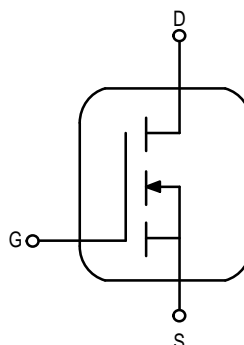

MRF182
MRF182S

30 W, 1.0 GHz
LATERAL N-CHANNEL
BROADBAND
RF POWER MOSFETs

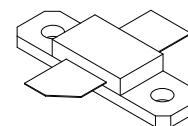

CASE 360B-01, STYLE 1
(MRF182)

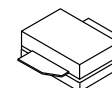

CASE 360C-03, STYLE 1
(MRF182S)

MAXIMUM RATINGS

Rating	Symbol	Value	Unit
Drain-Source Voltage	V_{DSS}	65	Vdc
Gate-Source Voltage	V_{GS}	± 20	Vdc
Total Device Dissipation @ $T_C = 70^\circ\text{C}$ Derate above 70°C	P_D	74 0.57	W W/ $^\circ\text{C}$
Storage Temperature Range	T_{stg}	- 65 to +150	$^\circ\text{C}$
Operating Junction Temperature	T_J	200	$^\circ\text{C}$

THERMAL CHARACTERISTICS

Characteristic	Symbol	Max	Unit
Thermal Resistance, Junction to Case	$R_{\theta JC}$	1.75	$^\circ\text{C}/\text{W}$

ELECTRICAL CHARACTERISTICS ($T_C = 25^\circ\text{C}$ unless otherwise noted)

Characteristic	Symbol	Min	Typ	Max	Unit
----------------	--------	-----	-----	-----	------

OFF CHARACTERISTICS

Drain-Source Breakdown Voltage ($V_{GS} = 0$, $I_D = 1.0 \mu\text{A}_{dc}$)	$V_{(BR)DSS}$	65	-	-	Vdc
Zero Gate Voltage Drain Current ($V_{DS} = 28 \text{ V}$, $V_{GS} = 0$)	I_{DSS}	-	-	1	μA_{dc}
Gate-Source Leakage Current ($V_{GS} = 20 \text{ V}$, $V_{DS} = 0$)	I_{GSS}	-	-	1	μA_{dc}

NOTE - CAUTION - MOS devices are susceptible to damage from electrostatic charge. Reasonable precautions in handling and packaging MOS devices should be observed.

ELECTRICAL CHARACTERISTICS – continued ($T_C = 25^\circ\text{C}$ unless otherwise noted)

Characteristic	Symbol	Min	Typ	Max	Unit
ON CHARACTERISTICS					
Gate Threshold Voltage ($V_{DS} = 10\text{ V}$, $I_D = 100\ \mu\text{A}$)	$V_{GS(th)}$	2	3	4	Vdc
Gate Quiescent Voltage ($V_{DS} = 28\text{ V}$, $I_D = 50\text{ mA}$)	$V_{GS(Q)}$	3	4	5	Vdc
Drain–Source On–Voltage ($V_{GS} = 10\text{ V}$, $I_D = 3\text{ A}$)	$V_{DS(on)}$	–	0.9	1.2	Vdc
Forward Transconductance ($V_{DS} = 10\text{ V}$, $I_D = 3\text{ A}$)	g_{fs}	1.6	1.8	–	S

DYNAMIC CHARACTERISTICS

Input Capacitance ($V_{DS} = 28\text{ V}$, $V_{GS} = 0$, $f = 1\text{ MHz}$)	C_{iss}	–	56	–	pF
Output Capacitance ($V_{DS} = 28\text{ V}$, $V_{GS} = 0$, $f = 1\text{ MHz}$)	C_{oss}	–	28	–	pF
Reverse Transfer Capacitance ($V_{DS} = 28\text{ V}$, $V_{GS} = 0$, $f = 1\text{ MHz}$)	C_{rss}	–	2.5	–	pF

FUNCTIONAL CHARACTERISTICS

Common Source Power Gain ($V_{DD} = 28\text{ Vdc}$, $P_{out} = 30\text{ W}$, $I_{DQ} = 50\text{ mA}$, $f = 945\text{ MHz}$)	G_{ps}	11	14	–	dB
Drain Efficiency ($V_{DD} = 28\text{ Vdc}$, $P_{out} = 30\text{ W}$, $I_{DQ} = 50\text{ mA}$, $f = 945\text{ MHz}$)	η	50	60	–	%
Load Mismatch ($V_{DD} = 28\text{ Vdc}$, $P_{out} = 30\text{ W}$, $I_{DQ} = 50\text{ mA}$, $f = 945\text{ MHz}$, Load VSWR 5:1 at All Phase Angles)	Ψ	No Degradation in Output Power			
Series Equivalent Input Impedance ($V_{DD} = 28\text{ Vdc}$, $P_{out} = 30\text{ W}$, $I_{DQ} = 50\text{ mA}$, $f = 960\text{ MHz}$)	Z_{in}	–	$0.81 + j1.6$	–	ohms
Series Equivalent Output Impedance ($V_{DD} = 28\text{ Vdc}$, $P_{out} = 30\text{ W}$, $I_{DQ} = 50\text{ mA}$, $f = 960\text{ MHz}$)	Z_{out}	–	$2.15 - j1.7$	–	ohms

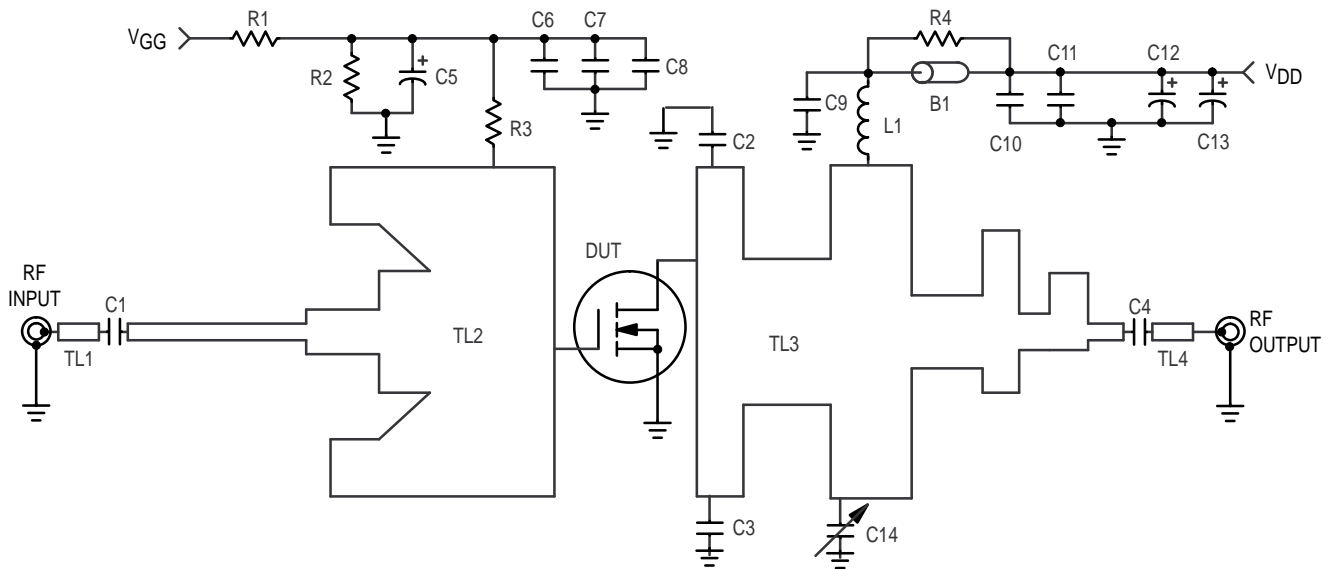

B1	Short RF Bead Fair Rite-274301944	L1	5 Turns, 20 AWG, IDIA 0.126
C1	18 pF Chip Capacitor	R1	10 k Ω , 1/4 W Resistor
C2, C3, C6, C9	43 pF Chip Capacitor	R2	13 k Ω , 1/4 W Resistor
C4	100 pF Chip Capacitor	R3	1.0 k Ω , 1/4 W Chip Resistor
C5, C12	10 μ F, 50 Vdc Electrolytic Capacitor	R4	4 x 39 Ω , 1/8 W Chip Resistor
C7, C10	1000 pF Chip Capacitor	"TL1-TL4	Microstrip Line See Photomaster
C8, C11	0.1 μ F, 50 Vdc Chip Capacitor	Ckt Board	1/32" Glass Teflon, $\epsilon_r = 2.55$
C13	250 μ F, 50 Vdc Electrolytic Capacitor		ARLON-GX-0300-55-22
C14	0.6-4.5 pF Variable Capacitor		

Figure 1. MRF182 Schematic

TYPICAL CHARACTERISTICS

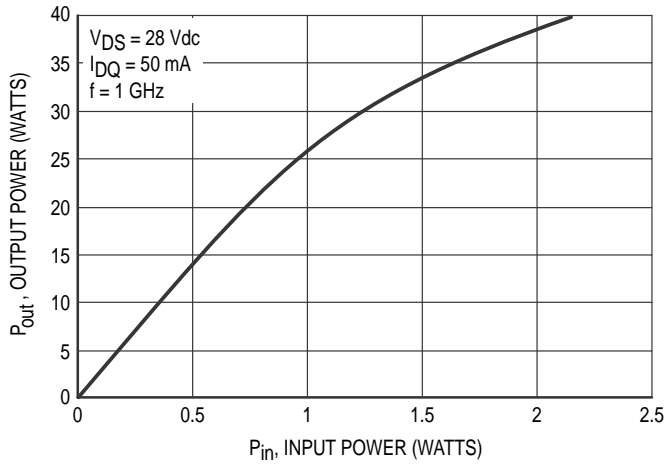

Figure 2. Output Power versus Input Power at 1 GHz

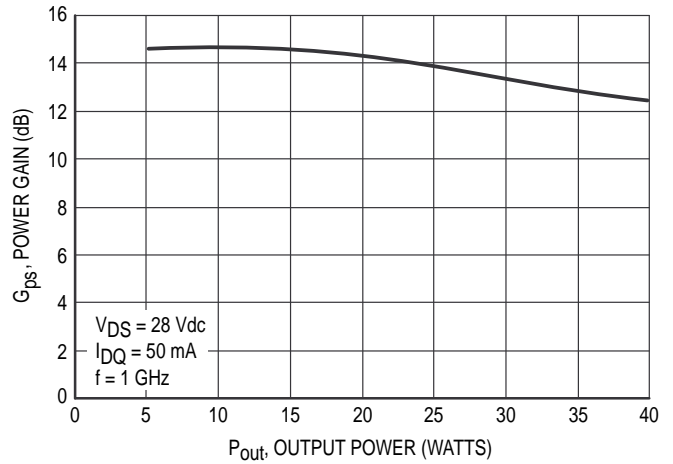

Figure 3. Power Gain versus Output Power at 1 GHz

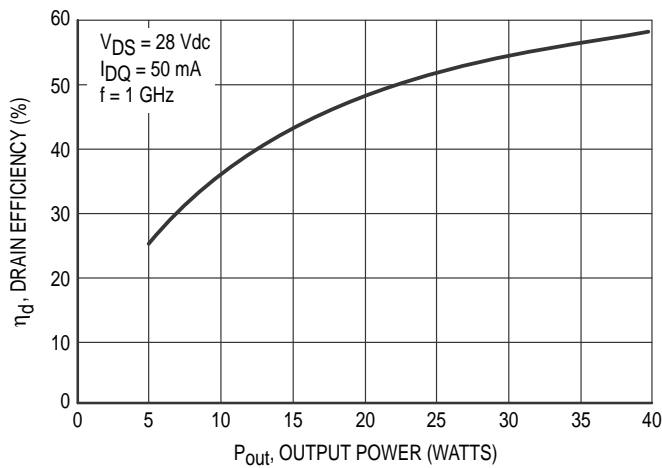

Figure 4. Drain Efficiency versus Output Power at 1 GHz

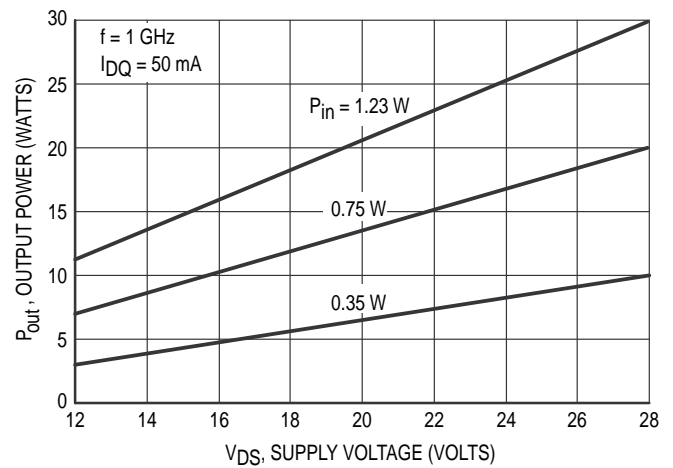

Figure 5. Output Power versus Supply Voltage

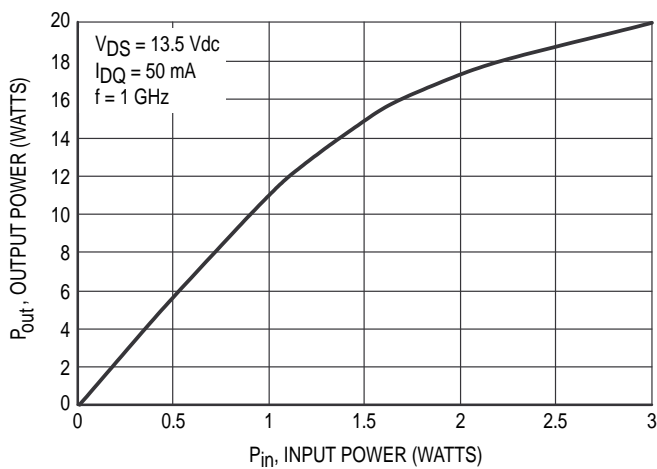

Figure 6. Output Power versus Input Power

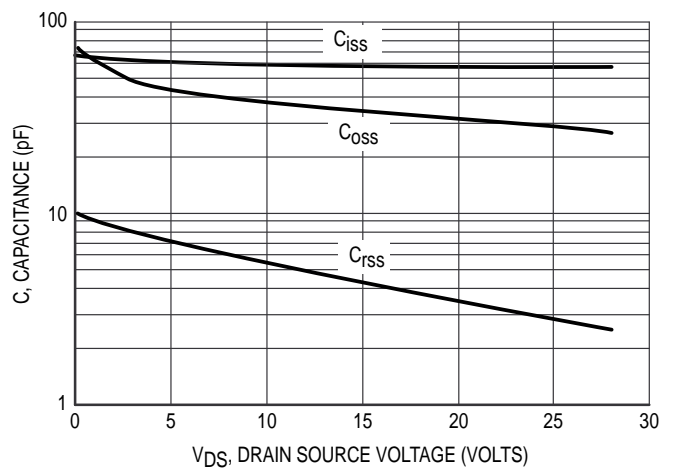

Figure 7. Capacitance versus Drain Source Voltage

Table 1. Typical Common Source S-Parameters ($V_{DS} = 13.5\text{ V}$)

$I_D = 1.0\text{ A}$

f MHz	S ₁₁		S ₂₁		S ₁₂		S ₂₂	
	S ₁₁	∠φ	S ₂₁	∠φ	S ₁₂	∠φ	S ₂₂	∠φ
20	0.933	-131	40.81	112	0.021	22	0.664	-138
30	0.922	-148	29.31	104	0.022	15	0.700	-151
40	0.892	-156	22.19	99	0.022	10	0.718	-158
50	0.877	-161	17.91	95	0.023	7	0.725	-162
60	0.870	-164	14.67	92	0.023	4	0.732	-164
70	0.863	-166	12.57	90	0.022	2	0.735	-166
80	0.860	-168	11.00	89	0.022	1	0.738	-168
90	0.860	-169	9.79	87	0.022	0	0.740	-169
100	0.859	-170	8.79	86	0.022	-1	0.741	-169
150	0.859	-173	5.78	80	0.022	-7	0.750	-172
200	0.862	-175	4.29	74	0.022	-11	0.759	-172
250	0.868	-176	3.38	69	0.021	-14	0.770	-173
300	0.880	-177	2.77	65	0.020	-17	0.780	-173
350	0.877	-177	2.32	61	0.020	-19	0.793	-173
400	0.882	-178	1.98	56	0.019	-22	0.808	-173
450	0.892	-179	1.72	52	0.018	-24	0.816	-173
500	0.899	-180	1.51	49	0.017	-26	0.828	-174
550	0.898	180	1.33	45	0.017	-27	0.838	-174
600	0.907	179	1.19	42	0.016	-28	0.849	-175
650	0.914	179	1.07	38	0.015	-28	0.859	-175
700	0.916	177	0.95	35	0.014	-25	0.867	-176
750	0.920	177	0.88	34	0.015	-26	0.874	-176
800	0.924	176	0.80	30	0.015	-27	0.884	-177
850	0.929	175	0.74	27	0.015	-33	0.891	-178
900	0.929	174	0.68	25	0.013	-38	0.897	-178
950	0.933	173	0.63	22	0.011	-39	0.905	-179
1000	0.934	173	0.58	20	0.010	-37	0.912	-180
1050	0.930	172	0.54	17	0.009	-33	0.918	180
1100	0.938	171	0.52	15	0.009	-29	0.924	179
1150	0.933	170	0.48	13	0.008	-28	0.929	178
1200	0.930	169	0.45	10	0.008	-25	0.930	177
1250	0.939	168	0.42	8	0.007	-23	0.935	177
1300	0.936	168	0.40	6	0.007	-21	0.934	176
1350	0.933	167	0.38	4	0.006	-19	0.936	175
1400	0.937	166	0.35	2	0.005	-14	0.939	174
1450	0.937	165	0.33	0	0.005	-5	0.934	174
1500	0.927	164	0.32	-2	0.004	0	0.930	173

Table 2. Typical Common Emitter S-Parameters ($V_{DS} = 28\text{ V}$)

$I_D = 1.0\text{ A}$

f MHz	S ₁₁		S ₂₁		S ₁₂		S ₂₂	
	S ₁₁	∠φ	S ₂₁	∠φ	S ₁₂	∠φ	S ₂₂	∠φ
20	0.964	-99	54.39	129	0.014	39	0.429	-108
30	0.949	-121	43.46	118	0.017	28	0.478	-125
40	0.909	-134	34.35	109	0.018	20	0.520	-137
50	0.884	-142	28.27	103	0.018	15	0.540	-144
60	0.875	-148	23.38	98	0.019	11	0.553	-149
70	0.862	-152	20.10	95	0.019	8	0.562	-152
80	0.861	-156	17.64	92	0.019	5	0.569	-154
90	0.858	-158	15.72	90	0.019	3	0.575	-156
100	0.858	-160	14.11	88	0.019	1	0.580	-157
150	0.856	-166	9.26	79	0.018	-7	0.606	-160
200	0.862	-169	6.80	71	0.018	-12	0.633	-161
250	0.871	-171	5.29	65	0.017	-16	0.661	-161
300	0.882	-173	4.27	59	0.016	-21	0.690	-162
350	0.883	-174	3.52	54	0.015	-23	0.718	-162
400	0.895	-175	2.97	49	0.014	-26	0.747	-163
450	0.904	-176	2.54	45	0.013	-28	0.767	-164
500	0.911	-177	2.20	41	0.012	-30	0.789	-165
550	0.911	-178	1.90	37	0.011	-30	0.807	-166
600	0.923	-179	1.69	33	0.010	-30	0.825	-167
650	0.929	-180	1.50	30	0.009	-29	0.841	-168
700	0.929	179	1.32	26	0.009	-22	0.855	-169
750	0.933	178	1.21	24	0.010	-22	0.865	-170
800	0.938	177	1.09	21	0.009	-20	0.877	-171
850	0.942	176	1.00	18	0.010	-31	0.886	-172
900	0.942	175	0.92	16	0.008	-37	0.894	-173
950	0.947	174	0.84	13	0.006	-38	0.904	-174
1000	0.946	173	0.77	11	0.005	-28	0.912	-175
1050	0.943	172	0.72	8	0.005	-18	0.919	-176
1100	0.948	171	0.67	6	0.004	-9	0.926	-177
1150	0.945	171	0.62	4	0.005	0	0.932	-178
1200	0.939	170	0.59	1	0.004	3	0.934	-179
1250	0.949	169	0.54	0	0.005	12	0.940	-180
1300	0.947	168	0.51	-3	0.005	18	0.939	180
1350	0.944	167	0.48	-4	0.005	22	0.941	179
1400	0.945	166	0.44	-7	0.004	34	0.943	178
1450	0.944	165	0.42	-9	0.005	45	0.940	177
1500	0.933	164	0.40	-10	0.005	55	0.936	176

PACKAGE DIMENSIONS

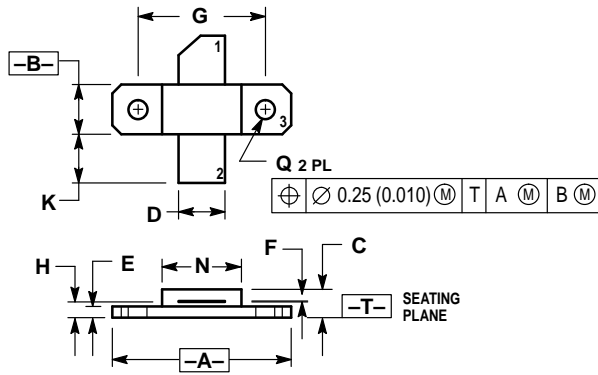

- NOTES:
 1. DIMENSIONING AND TOLERANCING PER ANSI Y14.5M, 1982.
 2. CONTROLLING DIMENSION: INCH.

DIM	INCHES		MILLIMETERS	
	MIN	MAX	MIN	MAX
A	0.790	0.810	20.07	20.57
B	0.220	0.240	5.59	6.09
C	0.125	0.175	3.18	4.45
D	0.205	0.225	5.21	5.71
E	0.050	0.070	1.27	1.77
F	0.004	0.006	0.11	0.15
G	0.562 BSC 14.27 BSC			
H	0.070	0.090	1.78	2.29
K	0.215	0.255	5.47	6.47
N	0.350	0.370	8.89	9.39
Q	0.120	0.140	3.05	3.55

- STYLE 1:
 PIN 1. DRAIN
 2. GATE
 3. SOURCE

**CASE 360B-01
 ISSUE O
 (MRF182)**

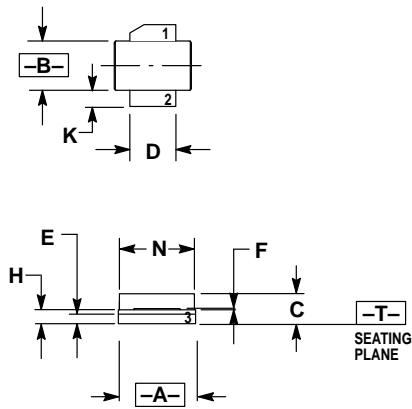

- NOTES:
 1. DIMENSIONING AND TOLERANCING PER ANSI Y14.5M, 1982.
 2. CONTROLLING DIMENSION: INCH.

DIM	INCHES		MILLIMETERS	
	MIN	MAX	MIN	MAX
A	0.370	0.390	9.40	9.91
B	0.220	0.240	5.59	6.09
C	0.105	0.155	2.67	3.94
D	0.205	0.225	5.21	5.71
E	0.035	0.045	0.89	1.14
F	0.004	0.006	0.11	0.15
H	0.057	0.067	1.45	1.70
K	0.085	0.115	2.16	2.92
N	0.350	0.370	8.89	9.39

- STYLE 1:
 PIN 1. DRAIN
 2. GATE
 3. SOURCE

**CASE 360C-03
 ISSUE B
 (MRF182S)**

Motorola reserves the right to make changes without further notice to any products herein. Motorola makes no warranty, representation or guarantee regarding the suitability of its products for any particular purpose, nor does Motorola assume any liability arising out of the application or use of any product or circuit, and specifically disclaims any and all liability, including without limitation consequential or incidental damages. "Typical" parameters which may be provided in Motorola data sheets and/or specifications can and do vary in different applications and actual performance may vary over time. All operating parameters, including "Typicals" must be validated for each customer application by customer's technical experts. Motorola does not convey any license under its patent rights nor the rights of others. Motorola products are not designed, intended, or authorized for use as components in systems intended for surgical implant into the body, or other applications intended to support or sustain life, or for any other application in which the failure of the Motorola product could create a situation where personal injury or death may occur. Should Buyer purchase or use Motorola products for any such unintended or unauthorized application, Buyer shall indemnify and hold Motorola and its officers, employees, subsidiaries, affiliates, and distributors harmless against all claims, costs, damages, and expenses, and reasonable attorney fees arising out of, directly or indirectly, any claim of personal injury or death associated with such unintended or unauthorized use, even if such claim alleges that Motorola was negligent regarding the design or manufacture of the part. Motorola and  are registered trademarks of Motorola, Inc. Motorola, Inc. is an Equal Opportunity/Affirmative Action Employer.

Mfax is a trademark of Motorola, Inc.

How to reach us:

USA/EUROPE/Locations Not Listed: Motorola Literature Distribution;
P.O. Box 5405, Denver, Colorado 80217. 303-675-2140 or 1-800-441-2447

JAPAN: Nippon Motorola Ltd.: SPD, Strategic Planning Office, 4-32-1,
Nishi-Gotanda, Shinagawa-ku, Tokyo 141, Japan. 81-3-5487-8488

Mfax™: RMFAX0@email.sps.mot.com – TOUCHTONE 602-244-6609
– US & Canada ONLY 1-800-774-1848

ASIA/PACIFIC: Motorola Semiconductors H.K. Ltd.; 8B Tai Ping Industrial Park,
51 Ting Kok Road, Tai Po, N.T., Hong Kong. 852-26629298

INTERNET: <http://motorola.com/sps>



MRF182/D