

GL79XX Series

NEGATIVE VOLTAGE REGULATOR

Description

The GL79XX series of fixed output negative voltage regulators are intended as complements to the popular GL78XX series devices. Available in fixed output voltage options from -5 to -24 Volts, these regulators employ internal current limiting, thermal shutdown, and safe-area compensation-making them remarkably rugged under most operating conditions. With adequate heat-sinking they can deliver output currents in excess of 1.0A.

Features

- High Line Regulation
- High Load Regulation
- Good Ripple Rejection (70dB)
- Low Temperature Coefficient of Output* (-1.0mV/°C)
- Wide Range Input Voltage
- Low Input Bias Current
- Low Output Noise
- Output Current in Excess of 1A

Pin Configuration

(Top View)

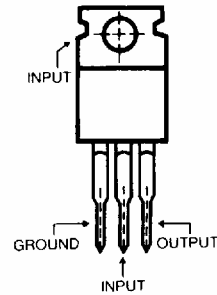

Type No/Voltage

GL7905	-5.0 Volts
GL7909	-9.0 Volts
GL7912	-12.0 Volts
GL7915	-15.0 Volts
GL7924	-24.0 Volts

Block Diagram

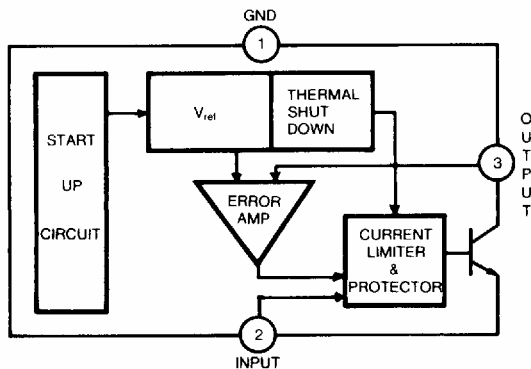

Maximum Ratings (T_A = 25°C)

- Input Voltage
(-5V Through -15V) -35V
(-24V) -40V
- Output Current 2.2A
- Power Dissipation Internally Limited
- Operating Junction Temp. 0°C to +150°C
- Storage Temp. -65°C to +150°C
- Lead Temp. (Soldering, 10S) 230°C

www.DataSheet4U.com

GL79XX Series

GL7905 Electrical Characteristics ($T_A = 25^\circ\text{C}$)

PARAMETER	SYMBOL	TEST CONDITIONS	VALUES		UNIT	
			MIN.	MAX.		
Output Voltage (1)	V_{O1}	$T_J = 25^\circ\text{C}$, $V_{in} = -10\text{V}$, $I_o = 500\text{mA}$	-5.2	-4.8	V	
Output Voltage (2)	V_{O2}	$-20\text{V} \leq V_{in} \leq -7\text{V}$, $5.0\text{mA} \leq I_o \leq 1.0\text{A}$	-5.25	-4.75	V	
Line Regulation	ΔV_{O1}	$T_J = 25^\circ\text{C}$	$-25\text{V} \leq V_{in} \leq -7\text{V}$, $I_o = 100\text{mA}$		50	mV
	ΔV_{O2}		$-12\text{V} \leq V_{in} \leq -8\text{V}$, $I_o = 100\text{mA}$		25	mV
	ΔV_{O3}		$-25\text{V} \leq V_{in} \leq -7\text{V}$, $I_o = 500\text{mA}$		100	mV
	ΔV_{O4}		$-12\text{V} \leq V_{in} \leq -8\text{V}$, $I_o = 500\text{mA}$		50	mV
Load Regulation	ΔV_{O5}	$T_J = 25^\circ\text{C}$	$5.0\text{mA} \leq I_o \leq 1.5\text{A}$, $V_{in} = -10\text{V}$		100	mV
	ΔV_{O6}		$250\text{mA} \leq I_o \leq 750\text{mA}$, $V_{in} = -10\text{V}$		50	mV
Quiescent Current	I_Q	$T_J = 25^\circ\text{C}$, $V_{in} = -10\text{V}$, $I_o = 500\text{mA}$		2.0	mA	
Quiescent Current Change	ΔI_{Q1}	$-25\text{V} \leq V_{in} \leq -17\text{V}$, $I_o = 500\text{mA}$		1.3	mA	
	ΔI_{Q2}	$V_{in} = -10\text{V}$, $5\text{mA} \leq I_o \leq 1.5\text{A}$		0.5	mA	
Output Noise Voltage	N_o	$V_{in} = -10\text{V}$, $I_o = 500\text{mA}$ $10\text{Hz} \leq f \leq 100\text{KHz}$		80	μV	
Ripple Rejection	R_R	$T_J = 25^\circ\text{C}$, $V_i = 1\text{V}_{(rms)}$, 120Hz , $I_o = 20\text{mA}$, $-18\text{V} \leq V_{in} \leq -8\text{V}$	54		dB	
Input-Output Voltage Differential	V_d	$T_J = 25^\circ\text{C}$, $I_o = 1.0\text{A}$		1.1(TYP)	V	

GL7909 Electrical Characteristics ($T_A = 25^\circ\text{C}$)

PARAMETER	SYMBOL	TEST CONDITIONS	VALUES		UNIT	
			MIN.	MAX.		
Output Voltage (1)	V_{O1}	$T_J = 25^\circ\text{C}$, $V_{in} = -15\text{V}$, $I_o = 500\text{mA}$	-9.35	-8.65	V	
Output Voltage (2)	V_{O2}	$-24\text{V} \leq V_{in} \leq -11.5\text{V}$, $5.0\text{mA} \leq I_o \leq 1.0\text{A}$	-9.55	-8.55	V	
Line Regulation	ΔV_{O1}	$T_J = 25^\circ\text{C}$	$-26\text{V} \leq V_{in} \leq -11.5\text{V}$, $I_o = 100\text{mA}$		90	mV
	ΔV_{O2}		$-18\text{V} \leq V_{in} \leq -12\text{V}$, $I_o = 100\text{mA}$		45	mV
	ΔV_{O3}		$-26\text{V} \leq V_{in} \leq -11.5\text{V}$, $I_o = 500\text{mA}$		180	mV
	ΔV_{O4}		$-18\text{V} \leq V_{in} \leq -12\text{V}$, $I_o = 500\text{mA}$		90	mV
Load Regulation	ΔV_{O5}	$T_J = 25^\circ\text{C}$	$5.0\text{mA} \leq I_o \leq 1.5\text{A}$, $V_{in} = -15\text{V}$		180	mV
	ΔV_{O6}		$250\text{mA} \leq I_o \leq 750\text{mA}$, $V_{in} = -15\text{V}$		90	mV
Quiescent Current	I_Q	$T_J = 25^\circ\text{C}$, $V_{in} = -15\text{V}$, $I_o = 500\text{mA}$		3	mA	
Quiescent Current Change	ΔI_{Q1}	$-26\text{V} \leq V_{in} \leq -11.5\text{V}$, $I_o = 500\text{mA}$		1.0	mA	
	ΔI_{Q2}	$V_{in} = -15\text{V}$, $5\text{mA} \leq I_o \leq 1.5\text{A}$		0.5	mA	
Output Noise Voltage	N_o	$V_{in} = -15\text{V}$, $I_o = 500\text{mA}$ $10\text{Hz} \leq f \leq 100\text{KHz}$		120	μV	
Ripple Rejection	R_R	$T_J = 25^\circ\text{C}$, $V_i = 1\text{V}_{(rms)}$, 120Hz , $I_o = 20\text{mA}$, $-22\text{V} \leq V_{in} \leq -12\text{V}$	54		dB	
Input-Output Voltage Differential	V_d	$T_J = 25^\circ\text{C}$, $I_o = 1.0\text{A}$		1.1(TYP)	V	

GL79XX Series

GL7912 Electrical Characteristics (T_A = 25°C)

PARAMETER	SYMBOL	TEST CONDITIONS	VALUES		UNIT	
			MIN.	MAX.		
Output Voltage (1)	V _{O1}	T _J = 25°C, V _{in} = -19V, I _o = 500mA	-12.5	-11.5	V	
Output Voltage (2)	V _{O2}	-27V ≤ V _{in} ≤ -14.5V, 5.0mA ≤ I _o ≤ 1.0A	-12.5	-11.4	V	
Line Regulation	ΔV _{O1}	T _J = 25°C		-30V ≤ V _{in} ≤ -14.5V, I _o = 100mA	120	mV
	ΔV _{O2}			-22V ≤ V _{in} ≤ -16V, I _o = 100mA	60	mV
	ΔV _{O3}			-30V ≤ V _{in} ≤ -14.5V, I _o = 500mA	240	mV
	ΔV _{O4}			-22V ≤ V _{in} ≤ -16V, I _o = 500mA	120	mV
Load Regulation	ΔV _{O5}	T _J = 25°C	5.0mA ≤ I _o ≤ 1.5A, V _{in} = -19V	240	mV	
	ΔV _{O6}		250mA ≤ I _o ≤ 750mA, V _{in} = -19V	120	mV	
Quiescent Current	I _Q	T _J = 25°C, V _{in} = -19V, I _o = 500mA		3	mA	
Quiescent Current Change	ΔI _{Q1}	-30V ≤ V _{in} ≤ -14.5V, I _o = 500mA		1.0	mA	
	ΔI _{Q2}	V _{in} = -19V, 5mA ≤ I _o ≤ 1.5A		0.5	mA	
Output Noise Voltage	N _o	V _{in} = -19V, I _o = 500mA 10Hz ≤ f ≤ 100KHz		150	μV	
Ripple Rejection	R _R	T _J = 25°C, V _r = 1V _(rms) , 120Hz, I _o = 20mA, -25V ≤ V _{in} ≤ -15V	54		dB	
Input-Output Voltage Differential	V _d	T _J = 25°C, I _o = 1.0A		1.1(TYP)	V	

GL7915 Electrical Characteristics (T_A = 25°C)

PARAMETER	SYMBOL	TEST CONDITIONS	VALUES		UNIT	
			MIN.	MAX.		
Output Voltage (1)	V _{O1}	T _J = 25°C, V _{in} = -23V, I _o = 500mA	-15.6	-14.4	V	
Output Voltage (2)	V _{O2}	-30V ≤ V _{in} ≤ -17.5V, 5.0mA ≤ I _o ≤ 1.0A	-15.75	-14.25	V	
Line Regulation	ΔV _{O1}	T _J = 25°C		-30V ≤ V _{in} ≤ -17.5V, I _o = 100mA	150	mV
	ΔV _{O2}			-26V ≤ V _{in} ≤ -20V, I _o = 100mA	75	mV
	ΔV _{O3}			-30V ≤ V _{in} ≤ -17.5V, I _o = 500mA	300	mV
	ΔV _{O4}			-26V ≤ V _{in} ≤ -20V, I _o = 500mA	150	mV
Load Regulation	ΔV _{O5}	T _J = 25°C	5.0mA ≤ I _o ≤ 1.5A, V _{in} = -23V	300	mV	
	ΔV _{O6}		250mA ≤ I _o ≤ 750mA, V _{in} = -23V	150	mV	
Quiescent Current	I _Q	T _J = 25°C, V _{in} = -23V, I _o = 500mA		3	mA	
Quiescent Current Change	ΔI _{Q1}	-30V ≤ V _{in} ≤ -17.5V, I _o = 500mA		1.0	mA	
	ΔI _{Q2}	V _{in} = -23V, 5mA ≤ I _o ≤ 1.5A		0.5	mA	
Output Noise Voltage	N _o	V _{in} = -23V, I _o = 500mA 10Hz ≤ f ≤ 100KHz		180	μV	
Ripple Rejection	R _R	T _J = 25°C, V _r = 1V _(rms) , 120Hz, I _o = 20mA, -28.5V ≤ V _{in} ≤ -18.5V	54		dB	
Input-Output Voltage Differential	V _d	T _J = 25°C, I _o = 1.0A		1.1(TYP)	V	

GL79XX Series

GL7924 Electrical Characteristics ($T_A = 25^\circ\text{C}$)

$C_{in} = 2\mu\text{F}$, $C_{out} = 1\mu\text{F}$

PARAMETER	SYMBOL	TEST CONDITIONS	VALUES		UNIT	
			MIN	MAX.		
Output Voltage (1)	V_{O1}	$T_J = 25^\circ\text{C}$, $V_{in} = -33\text{V}$, $I_o = 500\text{mA}$	-25	-23	V	
Output Voltage (2)	V_{O2}	$-38\text{V} \leq V_{in} \leq -27\text{V}$, $5.0\text{mA} \leq I_o \leq 1.0\text{A}$	-25.2	-22.8	V	
Line Regulation	ΔV_{O1}	$T_J = 25^\circ\text{C}$	$-38\text{V} \leq V_{in} \leq -27\text{V}$, $I_o = 100\text{mA}$		240	mV
	ΔV_{O2}		$-36\text{V} \leq V_{in} \leq -30\text{V}$, $I_o = 100\text{mA}$		120	mV
	ΔV_{O3}		$-38\text{V} \leq V_{in} \leq -27\text{V}$, $I_o = 500\text{mA}$		480	mV
	ΔV_{O4}		$-36\text{V} \leq V_{in} \leq -30\text{V}$, $I_o = 500\text{mA}$		240	mV
Load Regulation	ΔV_{O5}	$T_J = 25^\circ\text{C}$	$5.0\text{mA} \leq I_o \leq 1.5\text{A}$, $V_{in} = -33\text{V}$		480	mV
	ΔV_{O6}		$250\text{mA} \leq I_o \leq 750\text{mA}$, $V_{in} = -33\text{V}$		240	mV
Quiescent Current	I_Q	$T_J = 25^\circ\text{C}$, $V_{in} = -33\text{V}$, $I_o = 500\text{mA}$			3	mA
Quiescent Current Change	ΔI_{Q1}	$-38\text{V} \leq V_{in} \leq -27\text{V}$, $I_o = 500\text{mA}$			1.0	mA
	ΔI_{Q2}	$V_{in} = -33\text{V}$, $5\text{mA} \leq I_o \leq 1.5\text{A}$			0.5	mA
Output Noise Voltage	N_o	$V_{in} = -33\text{V}$, $I_o = 500\text{mA}$ $10\text{Hz} \leq f \leq 100\text{KHz}$			270	μV
Ripple Rejection	R_R	$T_J = 25^\circ\text{C}$, $V_i = 1V_{(rms)}$, 120Hz , $I_o = 20\text{mA}$, $-38\text{V} \leq V_{in} \leq -28\text{V}$	54			dB
Input-Output Voltage Differential	V_d	$T_J = 25^\circ\text{C}$, $I_o = 1.0\text{A}$			1.1 (TYP)	V

*GL79XX Series Test Circuit (AC & DC)

1 V_{O1} , V_{O2} , ΔV_o , I_Q , ΔI_Q , V_d

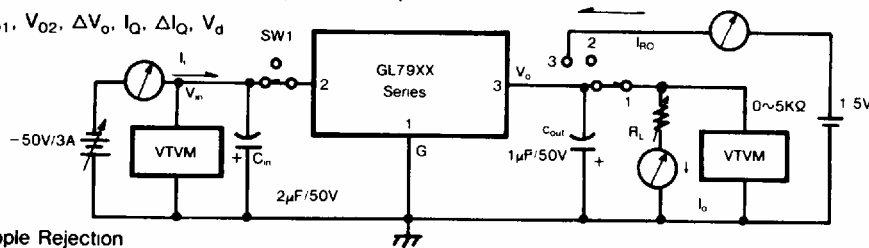

2. Ripple Rejection

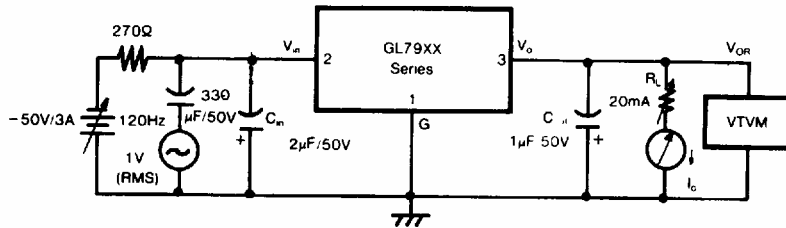

3. Output Noise Voltage

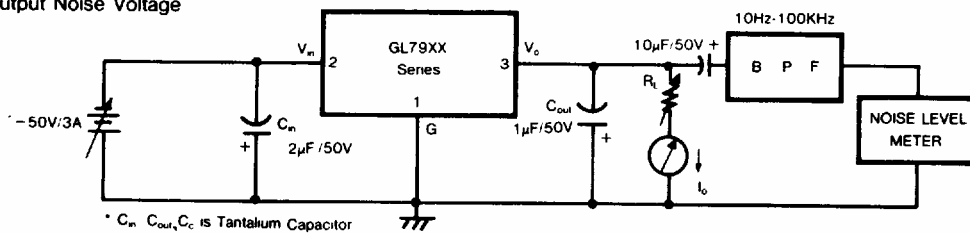

* C_{in} , C_{out} , C_c is Tantalum Capacitor

TYPICAL CHARACTERISTICS ($T_A = +25^\circ\text{C}$ unless otherwise noted.)

FIGURE 1 – AVERAGE CASE POWER DISSIPATION AS A FUNCTION OF AMBIENT TEMPERATURE (TO-220)

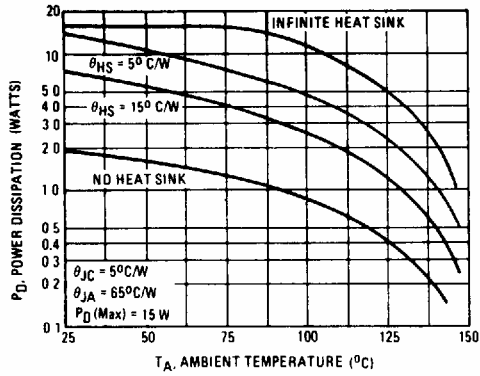

FIGURE 2 – PEAK OUTPUT CURRENT AS A FUNCTION OF INPUT-OUTPUT DIFFERENTIAL VOLTAGE

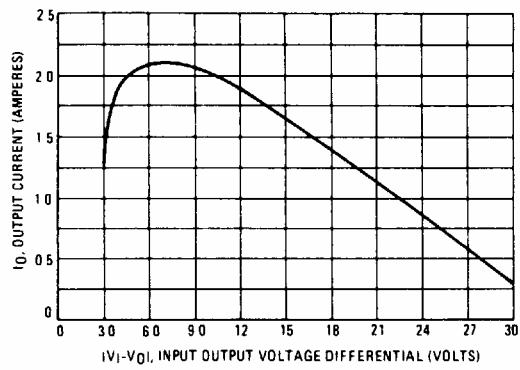

FIGURE 3 – RIPPLE REJECTION AS A FUNCTION OF FREQUENCY

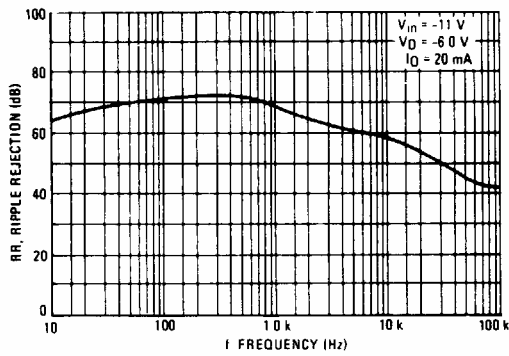

FIGURE 4 – RIPPLE REJECTION AS A FUNCTION OF OUTPUT VOLTAGES

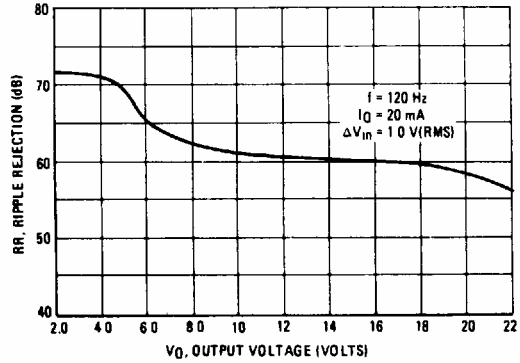

FIGURE 5 – OUTPUT VOLTAGE AS A FUNCTION OF JUNCTION TEMPERATURE

