

EMI FILTERED DC/DC CONVERTERS 28 VOLT INPUT

FEATURES

- EMI input filter, up to 50 dB attenuation
- -55° to +125°C operation
- High frequency output filter
- 17 to 40 VDC input
- Fully isolated, magnetic feedback
- 600 kHz typical—Single Ended Forward
- Inhibit and synchronization functions
- Indefinite short circuit protection
- Trim and remote sense on singles
- Up to 83% efficiency
- Up to 50V for 50 ms transient protection



MODELS	
VDC OUTPUT	
SINGLE	DUAL
3.3	±5
5	±12
12	±15
15	

Size (max): 3.005 x 1.505 x 0.400 inches (76.33 x 38.23 x 10.16 mm)
 Weight: 100 grams maximum
 Screening: Standard or ES, see the Environmental Screening table

DESCRIPTION

The FMTR Series™ of DC/DC converters offers up to 30 watts of output power from single or dual output configurations. They operate over the full military temperature range with up to 83% efficiency. FMTR converters are packaged in hermetically sealed metal cases, making them ideal for use in military, aerospace and other high reliability applications.

CONVERTER DESIGN

The FMTR converters are constant frequency, pulse-width modulated switching regulators which use a quasi-square wave, single ended, forward converter design. Tight load regulation is maintained via wide bandwidth magnetic feedback and, on single output models, through use of remote sense.

Indefinite short circuit protection and overload protection are provided by a constant current-limit feature. This protective system senses current in the converter's secondary stage and limits it to approximately 115% of the maximum rated output current.

BUILT-IN FILTERS

The built-in input and output filters reduce layout issues and conserve board space. The 2.7 amp EMI input filter meets MIL-STD-461C, CE03 and allows filtering of additional converters through the filter output pins. The output filter reduces high frequency common and differential mode noise. It allows a higher bandwidth ripple voltage measurement and eliminates the need for external output decoupling capacitors. Both input and output filters reduce radiated emissions providing quieter operation than conventional DC/DC converters.

WARNING: REQUIRED DAMPING NETWORK

To prevent damage to the internal circuitry an external capacitor and resistor are required across the filter outputs (pins 3 and 4) as shown in Figure 1. This applies to both single and dual output models. The recommended capacitor type is wet tantalum, MIL-C-39006.

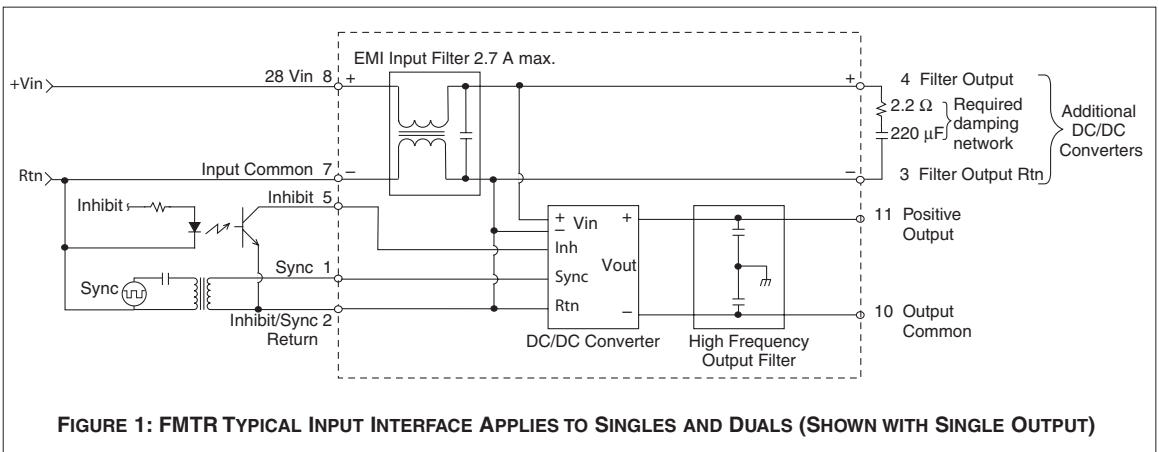

FIGURE 1: FMTR TYPICAL INPUT INTERFACE APPLIES TO SINGLES AND DUALS (SHOWN WITH SINGLE OUTPUT)

FMTR SERIES

30 WATT

DC/DC CONVERTERS

ABSOLUTE MAXIMUM RATINGS

- Input Voltage**
- 17 to 40 VDC
- Output Power**
- 25 to 30 watts depending on model
 - Input filter current, 2.7 A max.
- Lead Soldering Temperature (10 sec per pin)**
- 300°C
- Storage Temperature Range (Case)**
- -65°C to +135°C

RECOMMENDED OPERATING CONDITIONS

- Input Voltage Range**
- 17 to 40 VDC continuous
 - 50V for 50 ms transient protection
- Case Operating Temperature (Tc)**
- -55°C to +125°C full power
 - -55°C to +135°C absolute
- Derating Output Power/Current**
- Linearly from 100% at 125°C to 0% at 135°C

SYNC AND INHIBIT

- Sync (500 to 675 kHz)**
- Duty cycle 40% min, 60% max
 - Logic low 0.8 V max
 - Logic high 4.5 V min, 5 V max
 - Referenced to inh/sync return
 - If not used, connect to inh/sync return
- Inhibit TTL Open Collector**
- Logic low (output disabled)
Voltage ≤ 0.8 V
Inhibit pin current 8.0 mA max
 - Referenced to inh/sync return
 - Logic high (output enabled)
Open collector

EMI FILTER

Noise Rejection - Minimum	
500 kHz	55 dB
1 MHz	60 dB
5 MHz	60 dB

TYPICAL CHARACTERISTICS

- Output Voltage Temperature Coefficient**
- 100 ppm/°C typical
- Input to Output Capacitance**
- 50 pF typ
- Current Limit**
- 115% of full load typical
- Isolation**
- 100 megohm minimum at 500 V
- Audio Rejection**
- 40 dB typical
- Conversion Frequency**
- Free run 550 min, 600 typ, 650 max kHz
 - External sync 500 to 675 kHz
- Inhibit Pin Voltage (unit enabled)**
- 9 to 11 V
- Input Filter DC Resistance**
- 0.2 ohms max

Electrical Characteristics: -55°C to +125°C Tc, 28 VDC Vin, 100% load, free run, unless otherwise specified.

SINGLE OUTPUT MODELS		FMTR283R3S			FMTR2805S			FMTR2812S			FMTR2815S			UNITS
PARAMETER	CONDITION	MIN	TYP	MAX	MIN	TYP	MAX	MIN	TYP	MAX	MIN	TYP	MAX	
OUTPUT VOLTAGE	25°C	3.26	3.30	3.34	4.95	5.00	5.05	11.88	12.00	12.12	14.85	15.00	15.15	VDC
	-55°C TO +125°C	3.20	3.30	3.40	4.85	5.00	5.15	11.64	12.00	12.36	14.55	15.00	15.45	
OUTPUT CURRENT ¹	V _{IN} = 17 to 40 VDC	0	—	6.06	0	—	5.0	0	—	2.5	0	—	2.0	A
OUTPUT POWER ¹	V _{IN} = 17 to 40 VDC	0	—	20	0	—	25	0	—	30	0	—	30	W
OUTPUT RIPPLE VOLTAGE	10 kHz – 2 MHz 25°C	—	70	140	—	110	220	—	60	120	—	25	50	mV p-p
		—	—	180	—	—	260	—	—	160	—	—	90	
LINE REGULATION ²	V _{IN} = 17 to 40 VDC	—	—	10	—	15	50	—	15	50	—	15	50	mV
LOAD REGULATION	NO LOAD TO FULL	—	—	10	—	15	50	—	15	50	—	15	50	mV
INPUT VOLTAGE ¹	NO LOAD TO FULL	17	28	40	17	28	40	17	28	40	17	28	40	VDC
	NO LOAD	—	30	75	—	35	75	—	35	75	—	35	75	mA
INPUT CURRENT ¹	INHIBITED	—	7	8	—	3	8	—	3	8	—	3	8	mA
	NO LOAD	—	30	75	—	35	75	—	35	75	—	35	75	mA
INPUT RIPPLE CURRENT	10 kHz – 10 MHz	—	5	10	—	5	10	—	5	10	—	5	10	mA p-p
EFFICIENCY	INCLUDES FILTER 25°C	73	75	—	75	77	—	79	82	—	80	83	—	%
		70	72	—	72	74	—	76	78	—	77	79	—	
LOAD FAULT ³	POWER DISSIPATION	—	—	10	—	—	10	—	—	10	—	—	10	W
	SHORT CIRCUIT 25°C	—	—	12	—	—	12	—	—	12	—	—	12	
	-55°C TO +125°C	—	—	12	—	—	12	—	—	12	—	—	12	
	RECOVERY ^{4, 6}	—	1.4	6	—	1.4	5	—	1.4	5	—	1.4	5	ms
STEP LOAD RESP.	50% – 100% – 50% TRANSIENT RECOVERY ^{4, 6}	—	±125	±250	—	±200	±300	—	±250	±400	—	±350	±500	mV pk
		—	—	200	—	60	200	—	60	200	—	60	200	µs
STEP LINE RESP. ⁶	17 – 40 – 17 VDC TRANSIENT ⁵ RECOVERY ⁴	—	—	±300	—	±200	±300	—	±400	±500	—	±500	±600	mV pk
		—	—	300	—	—	300	—	—	300	—	—	300	µs
START-UP ¹	DELAY	—	1.4	5	—	1.4	5	—	1.4	5	—	1.4	5	ms
	OVERSHOOT ⁶	—	—	—	—	—	—	—	—	—	—	—	—	mV pk
	FULL LOAD	—	0	50	—	0	50	—	0	120	—	0	150	
	NO LOAD	—	33	150	—	50	250	—	120	600	—	150	750	

Notes

1. Tc = -55°C to +125°C
2. Operation is limited below 17V (see Figure 19).
3. Indefinite short circuit protection not guaranteed above 125°C case.
4. Recovery time is measured from application of the transient to point at which Vout is within 1% of final value.

5. Transition time ≥ 10 µs.
6. Parameter shall be tested as part of device characterization and after design and process changes. Thereafter, parameters shall be guaranteed to the limits specified in the electrical Characteristics table.

DC/DC CONVERTERS

FMTR SERIES 30 WATT

Electrical Characteristics: -55°C to +125°C Tc, 28 VDC Vin, 100% load, free run, unless otherwise specified.

DUAL OUTPUT MODELS		FMTR2805D			FMTR2812D			FMTR2815D			UNITS	
PARAMETER	CONDITIONS	MIN	TYP	MAX	MIN	TYP	MAX	MIN	TYP	MAX		
OUTPUT VOLTAGE	25°C	+V _{OUT}	4.95	5.00	5.05	11.88	12.00	12.12	14.85	15.00	15.15	VDC
		-V _{OUT}	4.90	5.00	5.08	11.80	12.00	12.18	14.76	15.00	15.23	
	-55°C TO +125°C	+V _{OUT}	4.85	5.00	5.15	11.64	12.00	12.36	14.55	15.00	15.45	
		-V _{OUT}	4.80	5.00	5.18	11.56	12.00	12.42	14.46	15.00	15.53	
OUTPUT CURRENT ^{1, 2}	V _{IN} = 17 TO 40 VDC	0	2.5	4.5	0	1.25	2.25	0	1.0	1.8	A	
OUTPUT POWER ^{1, 2}	V _{IN} = 17 TO 40 VDC	0	—	25	0	—	30	0	—	30	W	
OUTPUT RIPPLE VOLTAGE +/- V _{OUT}	10 kHz - 2 MHz	25°C	—	75	140	—	25	80	—	40	80	mV p-p
			—	—	180	—	—	120	—	—	120	
LINE REGULATION V _{IN} = 17 TO 40VDC		+V _{OUT}	—	10	50	—	10	50	—	10	50	mV
		-V _{OUT}	—	50	100	—	50	150	—	50	180	
LOAD REGULATION NO LOAD TO FULL		+V _{OUT}	—	5	50	—	15	50	—	15	50	mV
		-V _{OUT}	—	45	120	—	45	170	—	40	190	
CROSS REGULATION	25°C SEE NOTES 4 & 9	—	8	—	—	5	—	—	3	—	%	
EFFECT ON -V _{OUT}	25°C SEE NOTES 5 & 9	—	5	—	—	4	—	—	4	—		
INPUT VOLTAGE ¹ NO LOAD TO FULL	CONTINUOUS	17	28	40	17	28	40	17	28	40	VDC	
	TRANSIENT 50 ms	0	—	50	0	—	50	0	—	50	V	
INPUT CURRENT	NO LOAD	—	35	75	—	50	75	—	50	75	mA	
	INHIBITED	—	3	8	—	3	8	—	3	8	mA	
INPUT RIPPLE CURRENT ¹	10 kHz - 10 MHz	—	5	10	—	5	10	—	5	10	mA p-p	
EFFICIENCY	25°C		75	77	—	78	80	—	79	82	—	%
			72	74	—	75	77	—	76	78	—	
LOAD FAULT ⁶	POWER DISSIPATION	—	—	—	—	—	—	—	—	—	W	
	SHORT CIRCUIT -25°C	—	—	10	—	—	10	—	—	10		
	RECOVERY ⁹	—	—	12	—	—	12	—	—	12		
STEP LOAD RESPONSE ± V _{OUT}	50 – 100 – 50% BALANCED	—	1.4	5.0	—	1.4	5.0	—	1.4	5.0	ms	
	TRANSIENT	—	±200	±300	—	±150	±300	—	±200	±400		
	RECOVERY ^{7, 9}	—	100	200	—	100	200	—	100	200		
STEP LINE ⁹ RESPONSE ± V _{OUT}	17 – 40 – 17 V _{IN} TRANSIENT ⁶	—	±200	±400	—	±200	±400	—	±400	±500	mV pk	
	RECOVERY ⁷	—	—	300	—	—	300	—	—	300		
		—	—	—	—	—	—	—	—	—		
START-UP ¹	DELAY	—	1.4	5	—	1.4	5	—	1.4	5	ms	
	OVERSHOOT ⁹	—	—	—	—	—	—	—	—	—		
	FULL LOAD	—	0	50	—	0	120	—	0	150		
	NO LOAD	—	50	250	—	120	600	—	150	750	mV pk	

Notes

- Tc = -55°C to +125°C.
- Up to 90% of the total output current/power is available from either output providing the positive output is carrying at least 10% of the total output power.
- Operation is limited below 17 V (see Figure 19).
- Effect on the negative output under the following conditions:
+P_{out} 20% to 80%; -P_{out} 80% to 20%
- Effect on the negative output under the following conditions:
+P_{out} 50%; -P_{out} 10% to 50%
- Indefinite short circuit protection not guaranteed above 125°C case.
- Recovery time is measured from application of the transient to point at which V_{out} is within 1% of final value.
- Transition time ≥ 10 μs.
- Parameter shall be tested as part of device characterization and after design and process changes. Thereafter, parameters shall be guaranteed to the limits specified in the electrical Characteristics table.

TRIM AND REMOTE SENSE (AVAILABLE ON SINGLE OUTPUT MODELS ONLY)

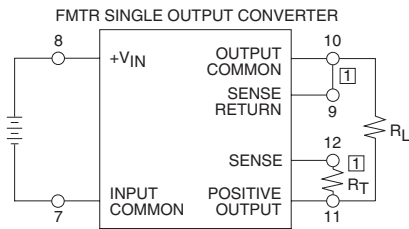

EXTERNAL TRIM CONNECTION

① Make connections at converter.

FIGURE 2: TRIM CONNECTION^{1, 2, 3}

Trim Formulas

V_{out} = desired output voltage; R_t = trim resistor

$$3.3V: R_t = \frac{1300 * V_{out} - 4304}{1.2475}$$

$$5V: R_t = \frac{1300 * V_{out} - 6512}{1.2475}$$

$$12V: R_t = \frac{1300 * V_{out} - 15631}{1.2475}$$

$$15V: R_t = \frac{1300 * V_{out} - 19498}{1.2475}$$

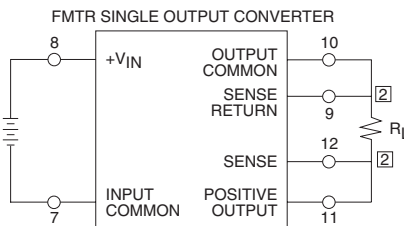

REMOTE SENSE CONNECTION

② Make connections at load.

FIGURE 3: REMOTE SENSE^{2, 3}

Notes for Remote Sense and Trim

1. When trimming output voltage and/or remote sensing, the total output voltage increase must be less than 0.6 volts at the converters pins to maintain specified performance.
2. If neither voltage trim nor remote sense will be used, connect pin 9 to pin 10 and pin 11 to pin 12 or the output voltage will increase by 1.2 volts
3. **CAUTION:** The converter will be permanently damaged if the positive remote sense (pin 12) is shorted to ground. Damage may also result if the output common or positive output is disconnected from the load with the remote sense leads connected to the load.

PIN OUT

Angled corner indicates pin one.

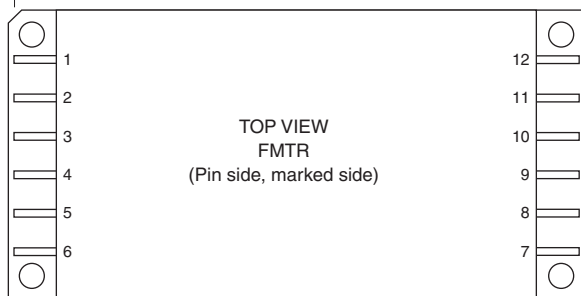

See page 7 for dimensions.

FIGURE 4: PIN OUT

Pin	Single Output	Dual Output
1	Sync	Sync
2	Inhibit/Sync Rtn	Inhibit/Sync Rtn
3	Filter Out Rtn	Filter Out Rtn
4	Filter Out	Filter Out
5	Inhibit	Inhibit
6	No connection	No connection
7	Input Common	Input Common
8	28 V Input	28V Input
9	Sense Rtn	No connection
10	Output Common	Negative Output
11	Positive Output	Output Common
12	Positive Sense	Positive Output

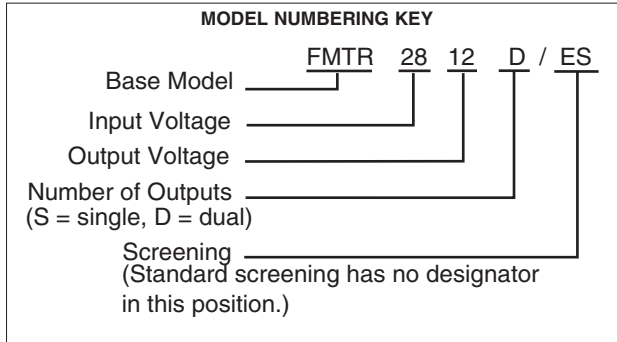

Typical Performance Curves: 25°C Tc, 28 VDC Vin, 100% load, free run, unless otherwise specified.

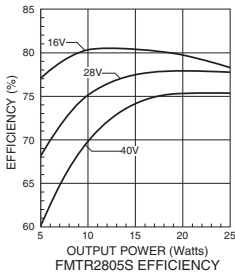

FIGURE 5

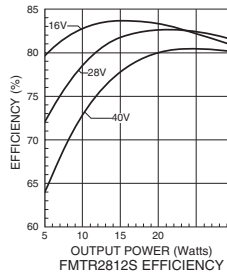

FIGURE 6

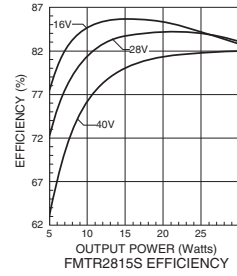

FIGURE 7

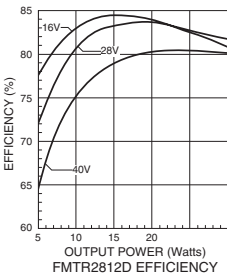

FIGURE 8

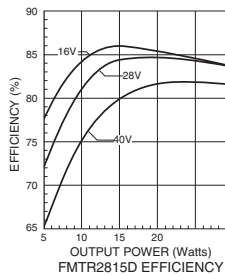

FIGURE 9

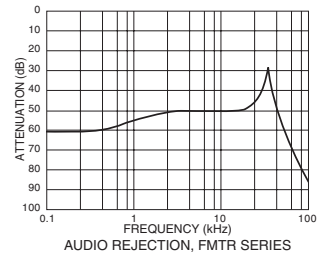

FIGURE 10

Typical Performance Curves: 25°C Tc, 28 VDC Vin, 100% load, free run, unless otherwise specified.

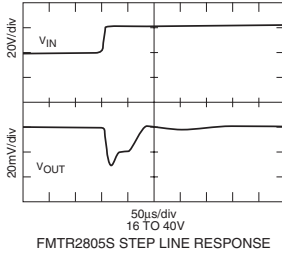

FIGURE 11

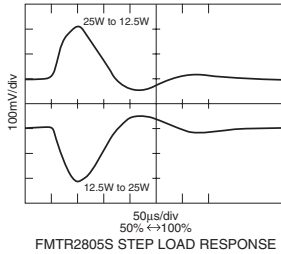

FIGURE 12

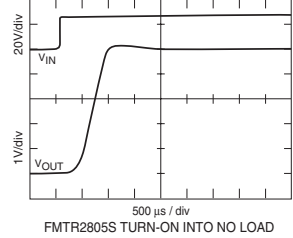

FIGURE 13

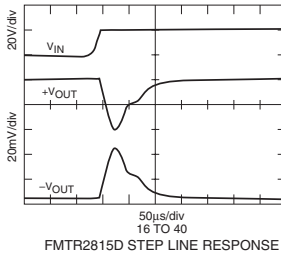

FIGURE 14

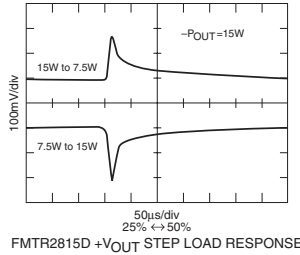

FIGURE 15

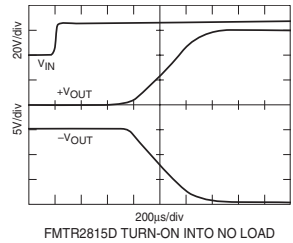

FIGURE 16

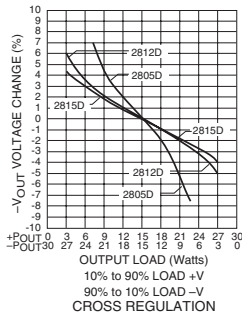

FIGURE 17

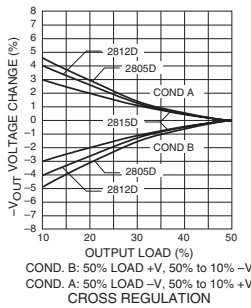

FIGURE 18

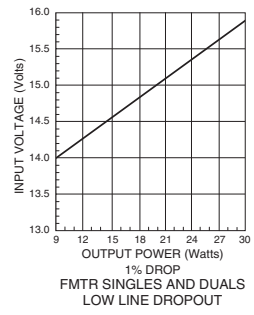
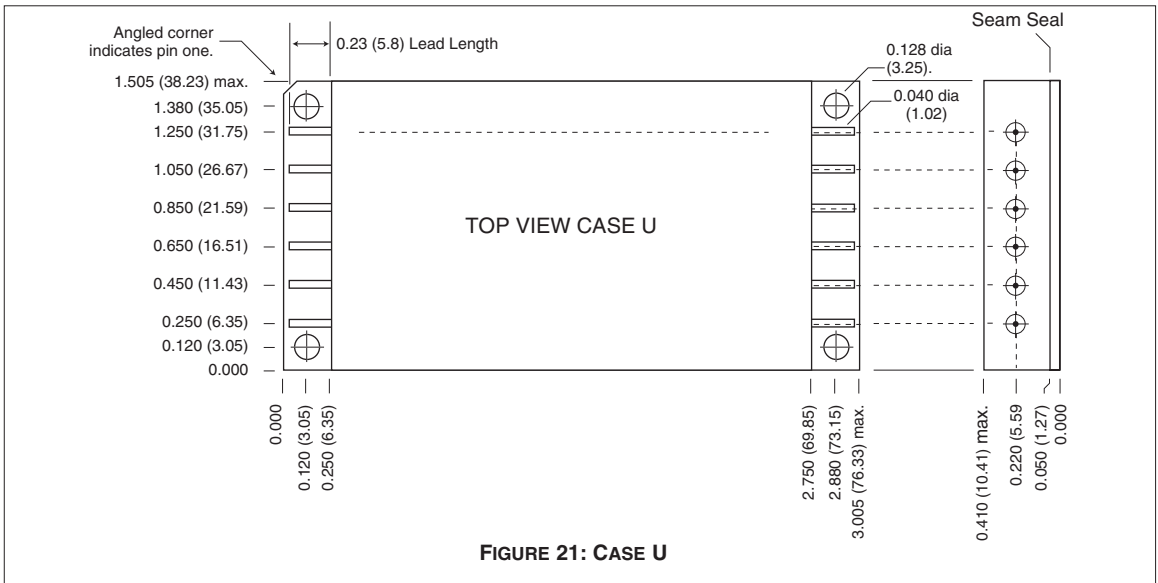
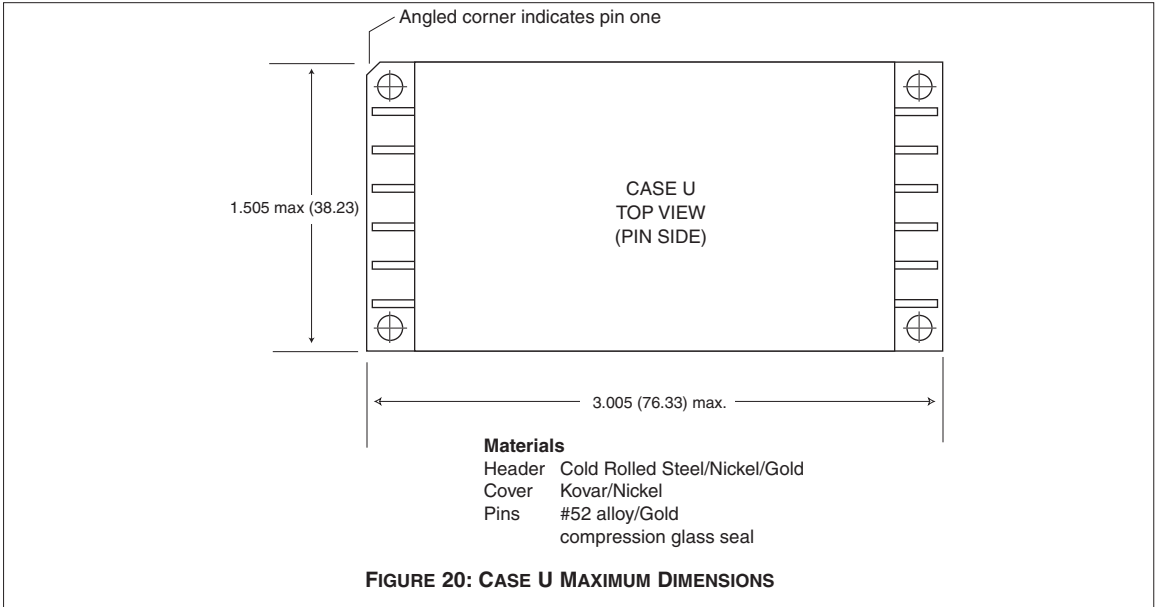

FIGURE 19



CAUTION

Heat from reflow or wave soldering may damage the device. Solder pins individually with heat application not exceeding 300°C for 10 seconds per pin.

Case dimensions in inches (mm)

Tolerance ± 0.005 (0.13) for three decimal places, ± 0.01 (0.2) for two decimal places unless otherwise specified

Although every effort has been made to render the case drawings at actual size, variations in the printing process may cause some distortion. Please refer to the numerical dimensions for accuracy.

ENVIRONMENTAL SCREENING

TEST	125°C STANDARD	125°C /ES
PRE-CAP INSPECTION 25°C Method 2017, 2032	yes	yes
TEMPERATURE CYCLE (10 times) Method 1010, Cond. B, -55°C to 125°C	no	yes
CONSTANT ACCELERATION 25°C Method 2001, 500 g	no	yes
BURN-IN 96 hours at 125°C case (typical)	no	yes
FINAL ELECTRICAL TEST MIL-PRF-38534, Group A Subgroups 1 and 4: +25°C case	yes	yes
HERMETICITY TESTING 25°C Fine Leak, Method 1014, Cond. A Gross Leak, Method 1014, Cond. C Gross Leak, Dip (1 x 10 ⁻³)	no no yes	yes yes no
FINAL VISUAL INSPECTION 25°C Method 2009	yes	yes

Test methods are referenced to MIL-STD-883 as determined by MIL-PRF-38534.

Contact Information:

www.interpoint.com

Interpoint Headquarters USA
Phone: 1-800-822-8782
+425-882-3100
Email: power@intp.com

Interpoint UK
Phone: +44-1252-872266
Email: poweruk@intp.com

Interpoint France
Phone: +33-134285455
Email: powerfr@intp.com