

DESCRIPTION The 2SA1206 is designed for general purpose amplifier and high speed switching applications.

- FEATURES**
- High Frequency Current Gain.
 - High Speed Switching.
 - Small Output Capacitance.
 - Low Collector Saturation Voltage.

ABSOLUTE MAXIMUM RATINGS (Ta=25 °C)

Maximum Temperatures	
Storage Temperature	-55 to +150 °C
Junction Temperature	150 °C Maximum
Maximum Power Dissipation (Ta=25 °C)	
Total Power Dissipation	600 mW
Maximum Voltages and Currents (Ta=25 °C)	
V _{CBO} Collector to Base Voltage	-15 V
V _{CEO} Collector to Emitter Voltage	-15 V
V _{EBO} Emitter to Base Voltage	-4.5 V
I _C Collector Current (D.C.)	-50 mA
I _C Collector Current (pulse) *	-100 mA

* PW ≤ 2 ms, duty cycle ≤ 50 %

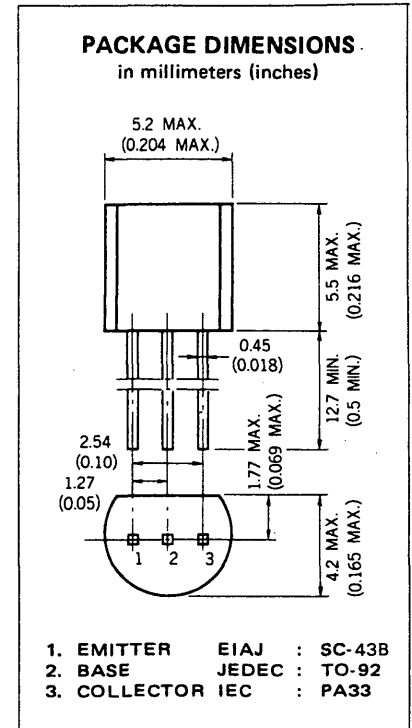

ELECTRICAL CHARACTERISTICS (Ta=25 °C)

SYMBOL	CHARACTERISTIC	MIN.	TYP.	MAX.	UNIT	TEST CONDITIONS
t _{on}	Turn-on Time		9.0	20	ns	See test circuit.
t _{off}	Turn-off Time		19	40	ns	See test circuit.
t _{stg}	Storage Time		16	40	ns	See test circuit.
f _T	Gain Bandwidth Product	800	1800		MHz	V _{CE} = -10 V, I _E = 10 mA, f = 100 MHz
C _{ob}	Output Capacitance		2.0	3.0	pF	V _{CB} = -5.0 V, I _E = 0, f = 1 MHz
h _{FE1} *	DC Current Gain	50	80	150	-	V _{CE} = -1.0 V, I _C = -10 mA
h _{FE2} *	DC Current Gain	30	70		-	V _{CE} = -1.0 V, I _C = -1.0 mA
V _{CE(sat)} *	Collector Saturation Voltage		-0.09	-0.20	V	I _C = -10 mA, I _B = -1.0 mA
V _{BE(sat)} *	Base Saturation Voltage		-0.80	-0.95	V	I _C = -10 mA, I _B = -1.0 mA
I _{CBO}	Collector Cutoff Current			-0.1	μA	V _{CB} = -8.0 V, I _E = 0
I _{EBO}	Emitter Cutoff Current			-0.1	μA	V _{EB} = -3.0 V, I _C = 0

* Pulsed PW ≤ 350 μs, duty cycle ≤ 2 %

TYPICAL CHARACTERISTICS ($T_a = 25^\circ\text{C}$)

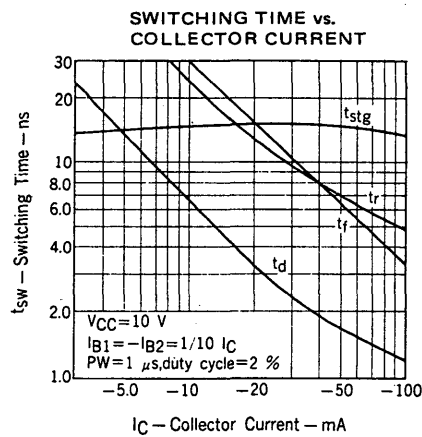
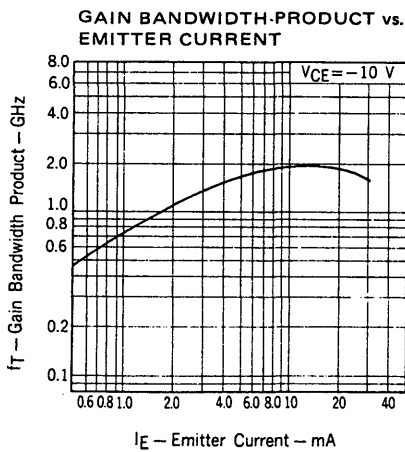
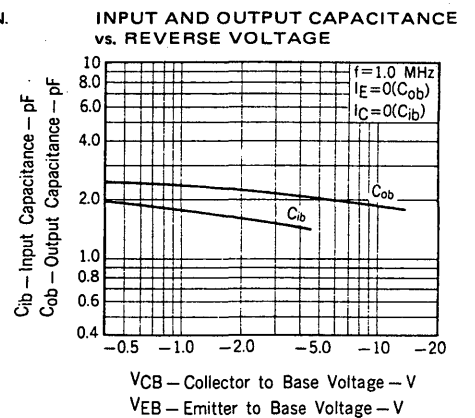
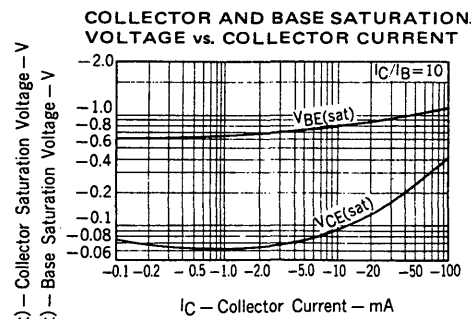
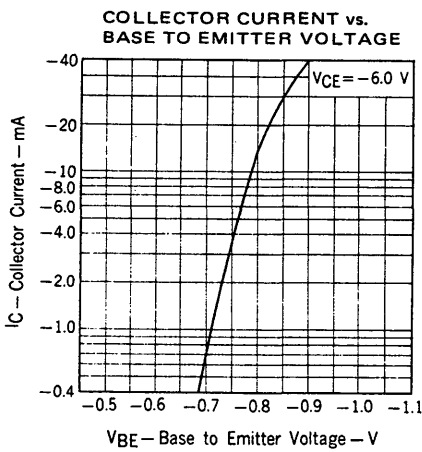
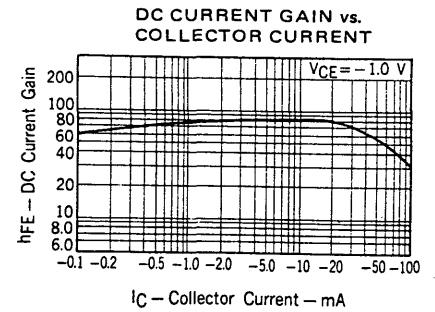
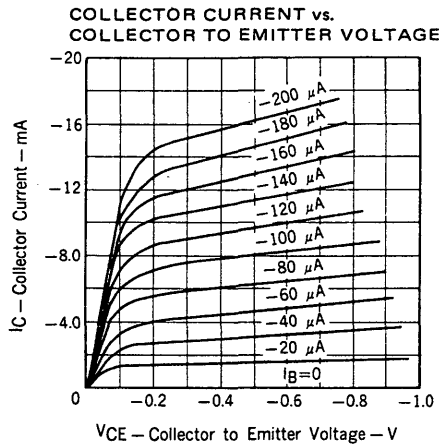
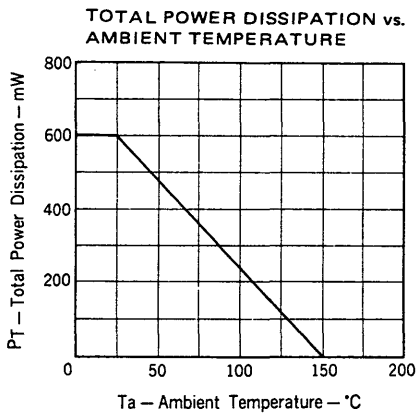

SWITCHING TIME TEST CIRCUIT

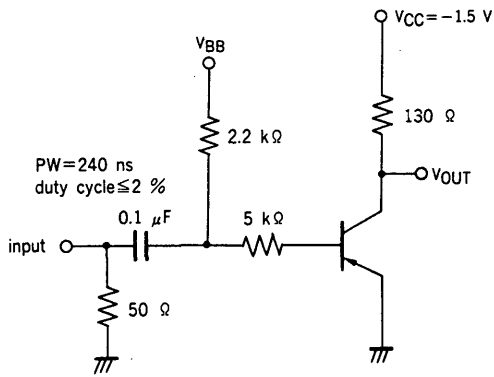

t_{on} , t_{off} Test Circuit

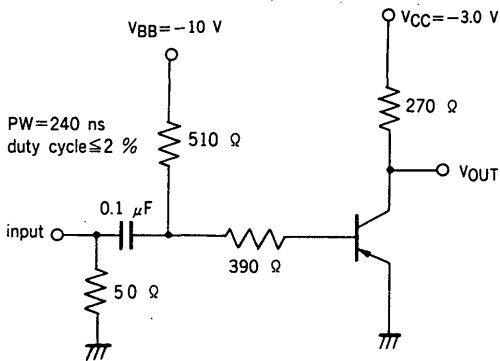
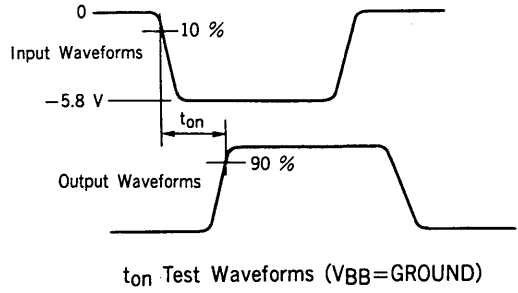

t_{stg} Test Circuit

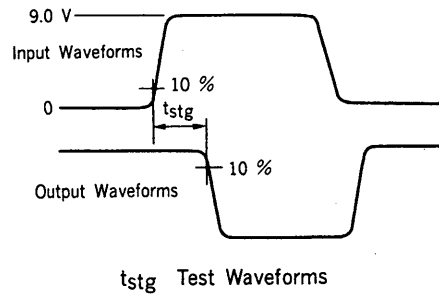
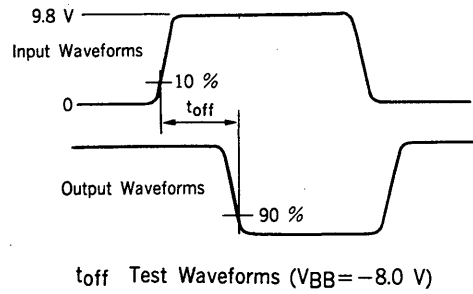

This datasheet has been downloaded from:

www.DatasheetCatalog.com

Datasheets for electronic components.