



Molded, 25 or 50 Mil Pitch, Dual-In-Line Resistor Networks

Models VTSR, VSSR, and VSOR



Actual Size

Vishay Thin Film resistor networks are designed to be used in either analog or digital circuits. The use of thin film resistive elements within the network allows you to achieve an infinite number of very low noise and high stability circuits for industrial, medical and scientific instrumentation.

Vishay Thin Film resistor networks are packaged in molded plastic packages with sizes that are recognized throughout the world. The rugged packaging offers superior environmental protection and consistent dimensions for ease of placement with automatic SMT equipment. Vishay Thin Film stocks many designs and values for off-the-shelf convenience.

With Vishay Thin Film you can depend on quality products delivered on time with service backing the product.

FEATURES

- Reduces total assembly costs
- Compatible with automatic surface mounting equipment
- UL 94V-0 flame resistant
- Thin film on silicon
- Choice of package sizes: VTSR (TSSOP), VSSR (SSOP or QSOP), VSOR (SOIC narrow)

TYPICAL PERFORMANCE

	ABS	TRACKING
	TCR	100
	ABS	RATIO
	TOL	5

Schematics

01 Schematic

Resistance Range:
10 Ω to 50K Ω

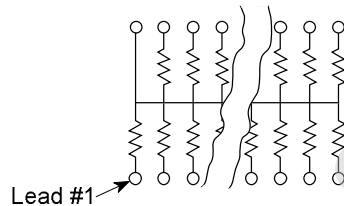

Resistors with one pin common

The 01 circuit provides nominally equal resistors connected between a common pin and a discrete PC board pin. Commonly used in the following applications:

- MOS/ROM Pull-up/Pull-down
- Open Collector Pull-up
- "Wired OR" Pull-up
- Power Driven Pull-up
- TTL Input Pull-down
- Digital Pulse Squaring
- TTL Unused Gate Pull-up
- High Speed Parallels Pull-up

03 Schematic

Resistance Range:
10 Ω to 50K Ω

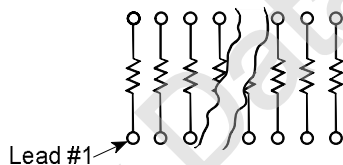

Isolated resistors

The 03 circuit provides nominally equal resistors isolated from all others and wired directly across. Commonly used in the following applications:

- "Wired OR" Pull-up
- Power Driven Pull-up
- Powergate Pull-up
- Line Termination
- Long-line Impedance Balancing
- LED Current Limiting
- ECL Output Pull-down
- TTL Input Pull-down

05 Schematic

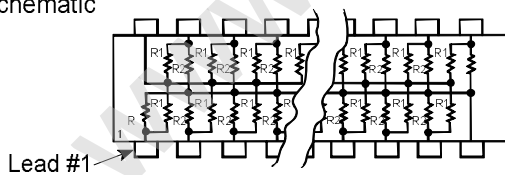

Dual-line terminator; pulse squaring

The 05 circuit contains pairs of resistors connected between ground and a common line. The junctions of these resistor pairs are connected to the input leads. The 05 circuits are designed for dual-line termination and pulse squaring. Standard values are:

VSSR1605 - $R_1 = 220 \Omega$, $R_2 = 160 \Omega$
 $R_1 = 330 \Omega$, $R_2 = 470 \Omega$
 VSSR2005 - $R_1 = 1.5K$, $R_2 = 3.3K \Omega$

47 Schematic

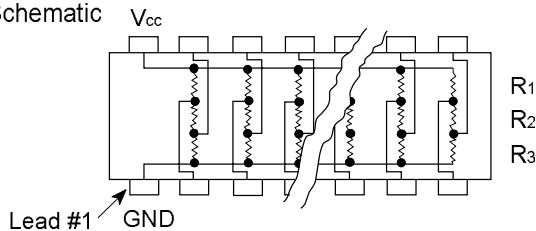

Differential terminator

The 47 schematic consists of series resistor sections connected between Vcc and Ground. Each contains 3 resistors of 2 different resistance values. Standard values are:

VSSR20 and VTSR20 - $R_1 = 270 \Omega$, $R_2 = 120 \Omega$
 $R_1 = 330 \Omega$, $R_2 = 220 \Omega$

Molded, 25 or 50 Mil Pitch, Dual-In-Line Resistor Networks

Models VTSR, VSSR, and VSOR



Test	Specifications	Conditions
Electrical Specifications	16, 20, 24	
TCR: Tracking	NA	
Absolute	± 100 ppm/ $^{\circ}\text{C}$	-55°C to $+125^{\circ}\text{C}$
Tolerance: Ratio	NA	
Absolute	$\pm 5\%$ standard ($\pm 2\%$ available)	
Power Rating: Resistor	100mW (Maximum)	@ $+70^{\circ}\text{C}$
Package	16 = 1.0 W 20 = 1.2 W 24 = 1.4 W	0°C to $+70^{\circ}\text{C}$
Voltage Coefficient	5 ppm/V typical	
Working Voltage	50 VDC	
Operating Temperature Range	-55°C to $+125^{\circ}\text{C}$	
Storage Temperature Range	-55°C to $+150^{\circ}\text{C}$	
Noise	< -35 dB	

Dimensions and Imprinting

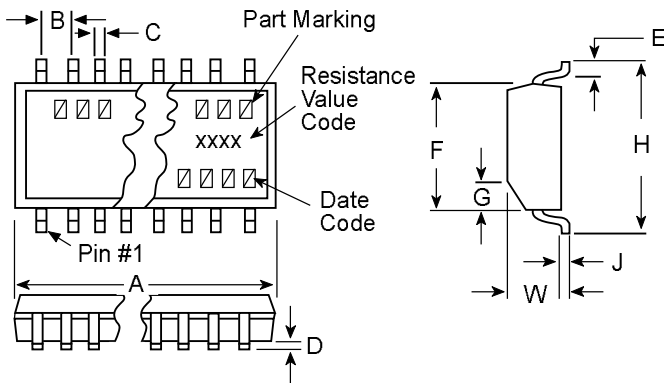

Marking

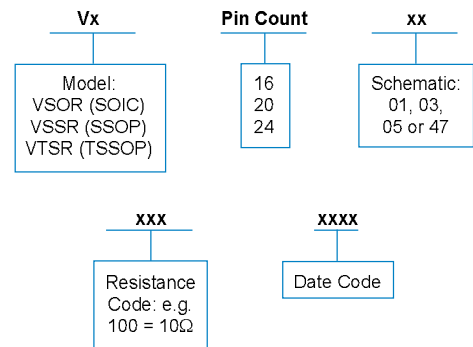

MODEL	A			B (Ref.)	C (Ref.)	D	E (Typ.)	F	G	H	J (Ref.)	W
	16 PIN	20 PIN	24 PIN									
VTSR-xxxx (millimeters)	0.206 \pm 0.003 5.23 \pm 0.08	0.256 \pm 0.003 6.50	0.306 \pm 0.003 7.77	0.025 0.64	0.087 0.22	0.004 0.10	0.024 0.61	0.173 \pm 0.003 4.39 \pm 0.08	0.015 x 45 $^{\circ}$ 0.38	0.252 \pm 0.005 6.40 \pm 0.13	0.005 0.13	0.043 \pm 0.005 1.09 \pm 0.13
VSSR-xxxx (millimeters)	0.193 \pm 0.004 4.90 \pm 0.10	0.341 \pm 0.003 8.66 \pm 0.08	0.341 \pm 0.003 8.66 \pm 0.08	0.025 0.64	0.010 0.25	0.006 0.15	0.025 0.64	0.154 \pm 0.003 3.91 \pm 0.08	0.015 x 45 $^{\circ}$ 0.38	0.236 \pm 0.008 5.99 \pm 0.20	0.010 0.25	0.064 \pm 0.005 1.63 \pm 0.13
VSOR-xxxx (millimeters)	0.390 \pm 0.010 9.91 \pm 0.25	NA	NA	0.050 1.27	0.016 0.41	0.008 0.20	0.030 0.76	0.152 \pm 0.003 3.86 \pm 0.08	0.015 x 45 $^{\circ}$ 0.38	0.236 \pm 0.005 5.99 \pm 0.13	0.008 0.20	0.064 \pm 0.005 1.63 \pm 0.13

NOTE: Mold flash not included in body dimensions.

Molded, 25 or 50 Mil Pitch, Dual-In-Line Resistor Networks

Models VTSR, VSSR, and VSOR



Mechanical Specifications

Resistive Element	Tantalum Nitride	Plating	Tin lead
Substrate Material	Silicon	Lead Coplanarity	0.0005"
Body	Molded epoxy	Marking Resistance to Solvents	Permanency
Terminals	Copper Alloy	testing per MIL-STD-202, Method 215.	

Packaging Information

MODEL	Leads	Tape and Reel	Tubes
VTSR	16	2,500	96
	20	2,500	74
	24	2,500	62
VSSR	16	2,500	98
	20	2,500	55
	24	2,500	55
VSOR	16	2,500	48

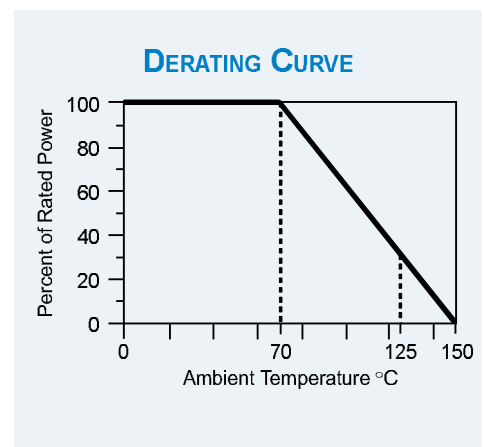

How to Order

Model	Number of Leads	Schematic	Resistance Value	Tolerance	Packaging
VTSR VSSR VSOR*	16 16 20 24	01 01 03	XXX First 2 digits are significant figures. Last digit specifies number of zeros to follow.	J G = ± 2% J = ± 5% (Std.)	T Tape and Reel = T/R Tubes = T

*16 Pin only

MODEL	Number of Leads	Schematic	Resistance Value	Tolerance	Packaging
VTSR VSSR VSOR*	16 16 20	05 05 47	XXX XXX R ₁ Value R ₂ Value First 2 digits are significant figures. Last digit specifies number of zeros to follow.	J G = ± 2% J = ± 5% (Std.)	T Tape and Reel = T/R Tubes = T

*16 Pin only

Example: **VSSR201102GT/R** = VSSR pkg., 20 pin count, 01 schematic, 1,000 ohms 2%, tape and reel.