

System Reset (with battery back-up) Monolithic IC MM1025, 1174

Outline

These ICs were developed for D-RAM and dummy S-RAM battery back-up. D-RAM and dummy S-RAM power supplies differ from that of S-RAMs because 5V or 3.3V of power supply is required even during battery back-up. Therefore, these ICs provide voltage from a stable power supply during both normal operation and back-up. Also, the internal stable power supply switches automatically to battery back-up if the main power supply voltage goes down for any reason.

Features

1. Battery back-up

MM1025

Current consumption		600 μ A typ.
Input/output voltage difference	$I_L=40\text{mA}$	0.25V typ.
Output current		40mA max.

MM1174

Current consumption		300 μ A typ.
Input/output voltage difference	$I_L=40\text{mA}$	0.13V typ.
Output current		40mA max.

2. Normal operation

MM1025

Input/output voltage difference	$I_L=80\text{mA}$ (built-in transistor)	0.29V typ.
Output current	$V_{CC}=6\text{V}$	80mA typ.
External transistor drive current	$V_{CC}=6\text{V}$	15mA typ.
Current consumption		900 μ A max.

MM1174 (for external transistor)

Input/output voltage difference	$I_L=200\text{mA}$	0.13V typ.
Output current		Depends on external transistor
External transistor drive current (no built-in TR)	$V_{CC}=3.6\text{V}$	10mA typ.
Current consumption		500 μ A max.

3. Switching voltage from V_{CC} to Battery $V_{CC}=\text{High}\rightarrow\text{Low}$

MM1025	4.9V typ.
MM1174	3.25V typ.

4. V_{CC} -Battery forced switching and detection voltage adjustment possible

Package

SOP-8A

Applications

1. Memory cards (D-RAM cards, other)
2. PCs, word processors and other equipment with D-RAMs
3. Fax machines, photocopiers and other office equipment with D-RAMs

Pin Assignment

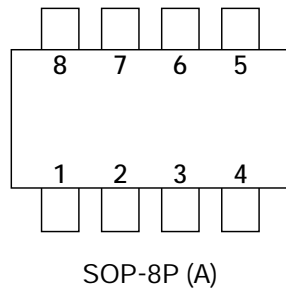

1	
2	GND
3	GND
4	CS
5	V _{BATT}
6	V _{OUT}
7	V _{CC}
8	TRB

Pin Description

Pin No.	Pin name	Function
1		Forced switching and detection voltage adjustment
2	GND	
3	GND	
4	CS	
5	V _{BATT}	
6	V _{OUT}	
7	V _{CC}	
8	TRB	External transistor drive

Block Diagram

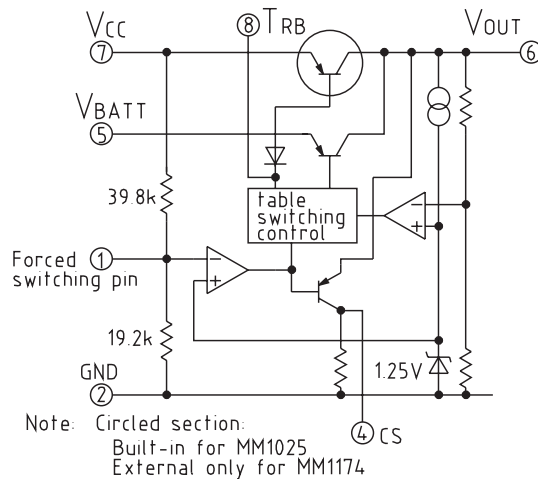

Absolute Maximum Ratings (Ta=25°C)

Item	Symbol	Rating	Units
Operating temperature	T _{OPR}	-20~+70	°C
Storage temperature	T _{STG}	40~+125	°C
Maximum output current 1	I _{L max.}	80	mA
Maximum output current 2	I _{L max.}	40	mA
Power supply voltage	V _{CC}	-0.3~+18	V
Power consumption	P _d	300	mW

Electrical Characteristics (Ta=25°C)

Item	Symbol	Measurement conditions	Min.	Typ.	Max.	Units	
Consumption current 1	MM1025	I_{CC}	$V_{CC}=6V, V_{BATT}=0V, I_L=0mA$	0.6	0.9	1.20	mA
	MM1174						
I/O voltage difference 1 *1	MM1025	V_{SAT1}	$V_{CC}=5V, V_{BATT}=0V, I_L=80mA$	0.15	0.29	0.40	V
	MM1174						
Consumption current 2	MM1025	I_{BATT}	$V_{CC}=0V, V_{BATT}=6V, I_L=0mA$	400	600	780	μA
	MM1174						
I/O voltage difference 2	MM1025	V_{SAT2}	$V_{CC}=0V, V_{BATT}=5V, I_L=40mA$	0.15	0.25	0.40	V
	MM1174						
Output voltage	MM1025	V_{OUT}	$V_{CC}=6V$ or $V_{BATT}=6V, I_L=5mA$	4.8	5.0	5.2	V
	MM1174						
Load fluctuation rate	MM1025	REG-L	$V_{CC} : I_L=0\sim 80mA, V_{BATT} : I_L=0\sim 40mA$			0.05	%/mA
	MM1174						
Input fluctuation rate	MM1025	REG-IN	V_{CC} or $V_{BATT}=5.5\sim 10V, I_L=5mA$			0.05	%/V
	MM1174						
Output voltage temperature coefficient	MM1025	TC_{VO}	V_{CC} or $V_{BATT}=6V, I_L=5mA$		0.01		%/°C
	MM1174						
Switching voltage (H→L)	MM1025	V_{TH1}	$V_{CC}=6V \rightarrow 4V, V_{BATT}=6V, I_L=40mA$	4.8	4.9	5.1	V
	MM1174						
Hysteresis voltage	MM1025	V_{HYS}	$V_{CC}=4V \rightarrow 6V, V_{BATT}=6V, I_L=40mA$	100	200	400	mV
	MM1174						
Maximum base driving current	MM1025	$I_B \text{ max.}$	$V_{CC}=6V, V_{CC} \rightarrow \text{Ampere meter} \rightarrow 8PIN$	9.0	15.0	20.0	mA
	MM1174						
CS output voltage H	MM1025	ΔV_{CSH}	$V_{CC}=6V, V_{BATT}=6V, V_{OUT}-V_{CS}$		0.10	0.50	V
	MM1174						
CS output voltage L	MM1025	V_{CSL}	$V_{CC}=4V, V_{BATT}=6V$			0.50	V
	MM1174						

Timing Chart

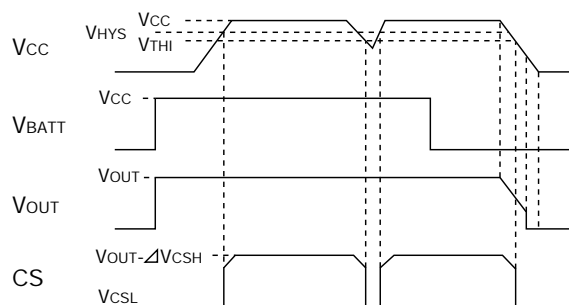

Characteristics (MM1025 series)

■ Output voltage and current consumption for V_{CC} voltage supply

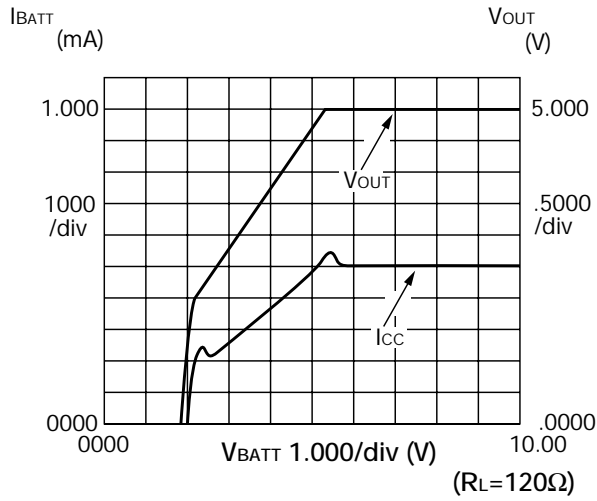

■ Output voltage and current consumption for battery voltage supply

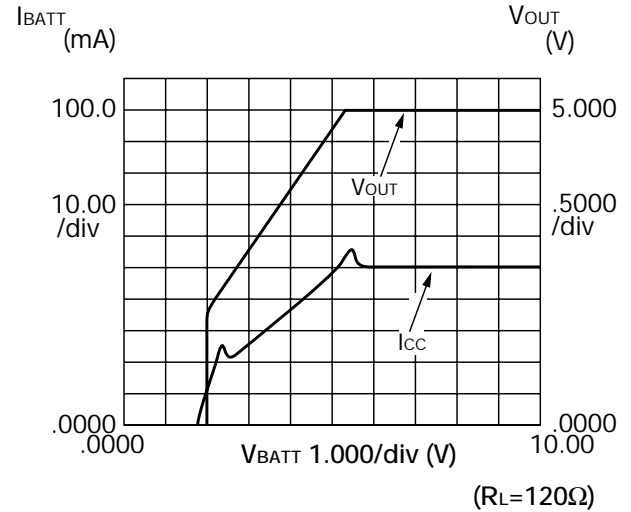

■ Output voltage and current consumption for V_{CC} voltage supply

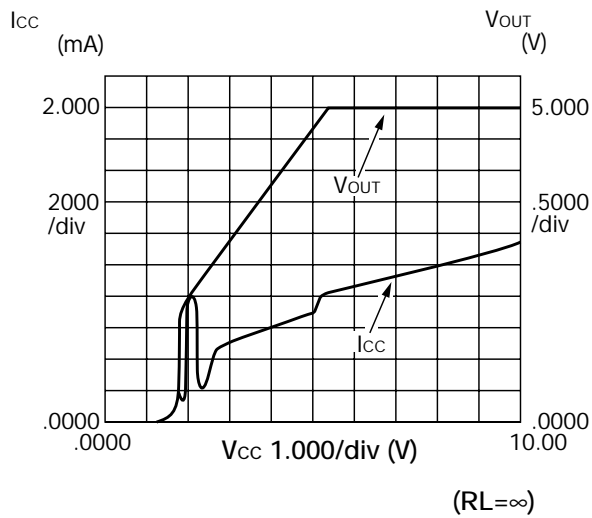

■ Output voltage and current consumption for battery voltage supply

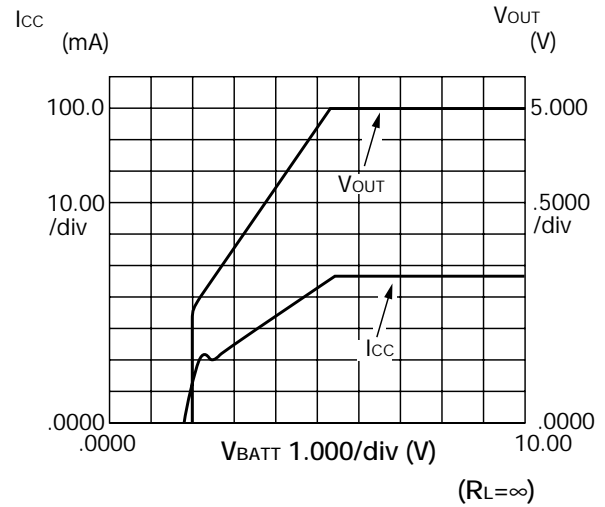

■ Power supply switching voltage

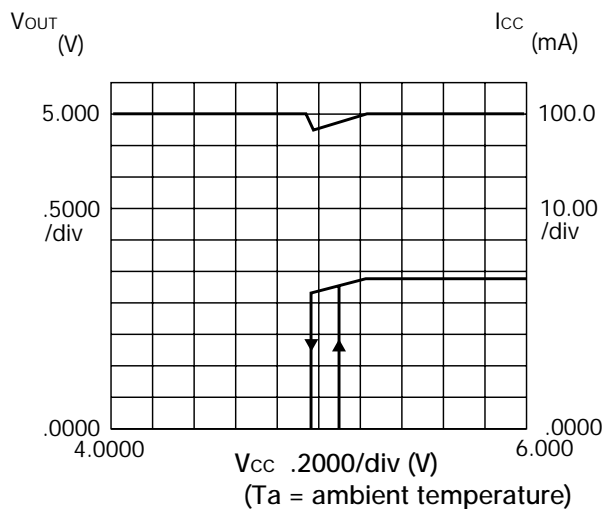

■ V_{CC} output current (external power transistor)

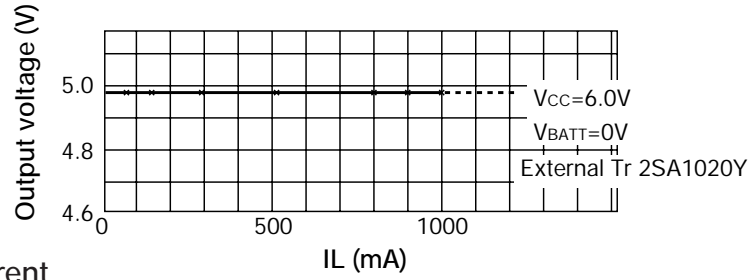

■ V_{BATT} output current

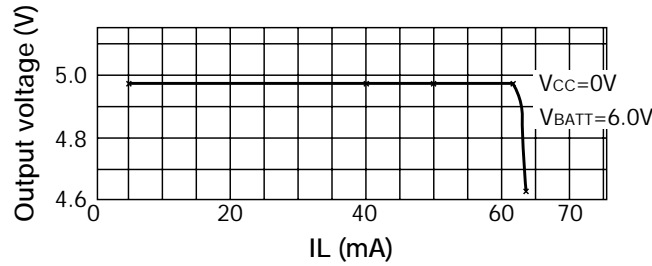

■ V_{CC} output current (no external power transistor)

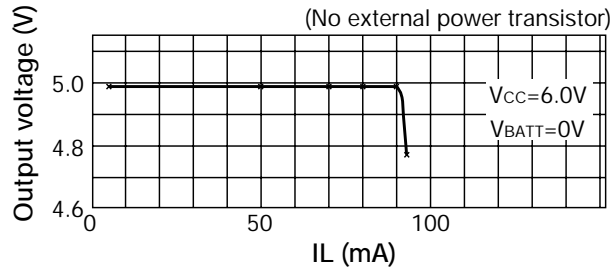

Characteristics (MM1174 series)

■ Current consumption 1-2 temperatures

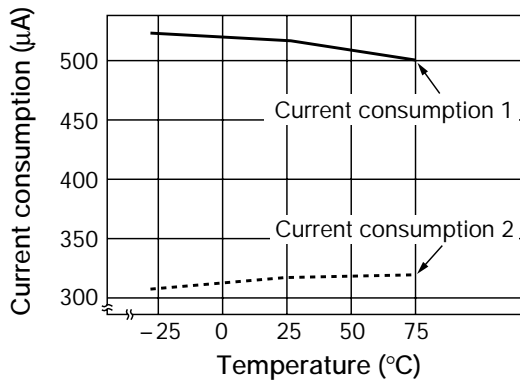

■ Input/output voltage difference 1 temperature (external transistor 2SA1020)

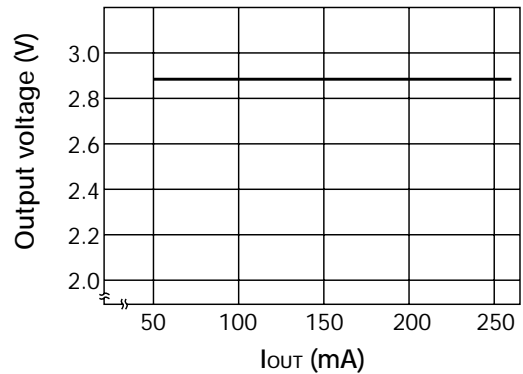

■ Input/output voltage difference 2 temperature ■ Output voltage - Temperature

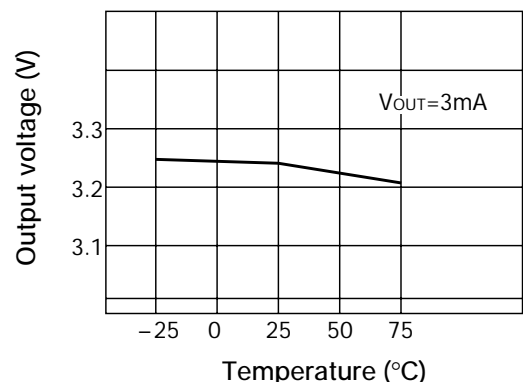
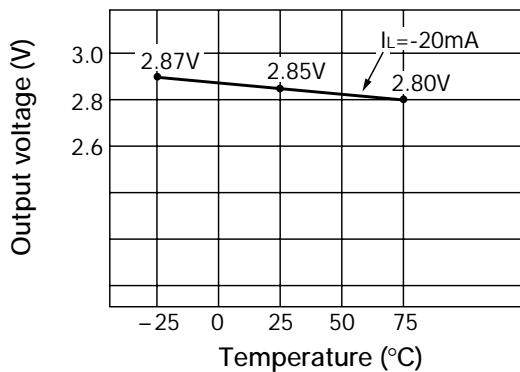

■ Maximum base drive current-Temperature

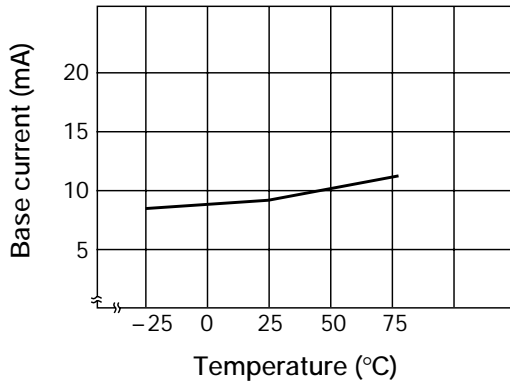

■ CS output voltage H-L temperature

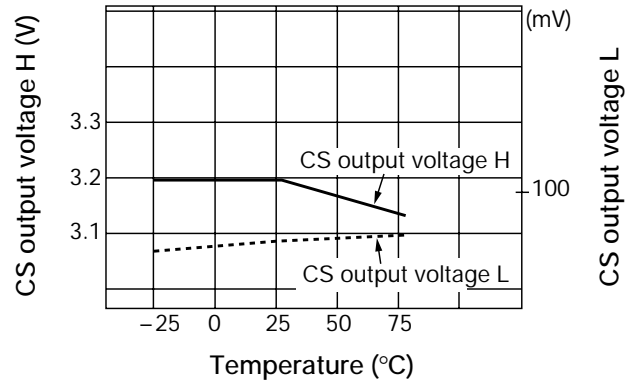

■ Base drive current

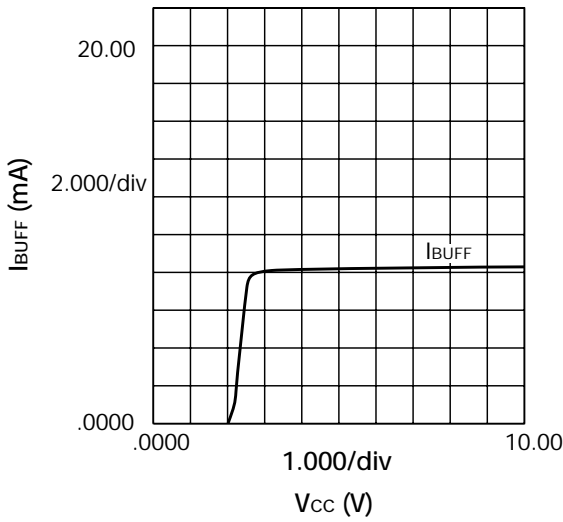

■ Vcc - Icc, IBATT

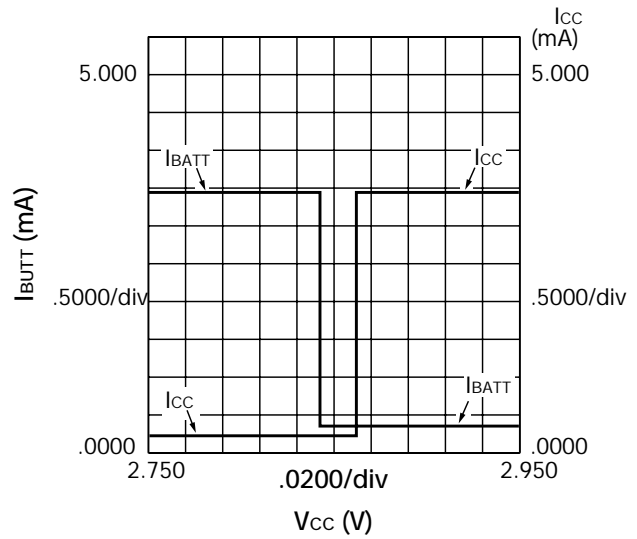

■ Vcc - Vout, Vcs

