

DATA SHEET

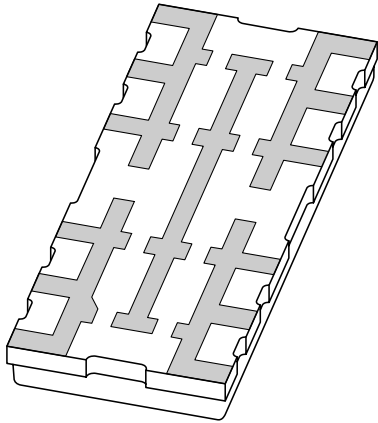

BGY282

dual band UHF amplifier module
for GSM900 and GSM1800

Preliminary specification

2001 Dec 04

dual band UHF amplifier module for GSM900 and GSM1800 BGY282

FEATURES

- Dual band GSM amplifier
- 3.5 V nominal supply voltage
- 33 dBm output power for GSM1800
- 35 dBm output power for GSM900
- Easy output power control by DC voltage
- Internal input and output matching
- Easy band selection by DC voltage
- Suited for GPRS class 12 (duty cycle 4 : 8).

APPLICATIONS

- Digital cellular radio systems with Time Division Multiple Access (TDMA) operation (GSM systems) in two frequency bands: 880 to 915 MHz and 1710 to 1785 MHz.

DESCRIPTION

The BGY282 is a power amplifier module in a SOT632A surface mounted ceramic package with a plastic cap. The module consists of two separated line-ups, one for GSM900 and one for GSM1800 with internal power control, input and output matching.

PINNING - SOT632A

PIN	DESCRIPTION
1	RF input 1 (GSM900)
2	V _{APC}
3, 6, 9, 12	Ground
4	V _{S1} (GSM900)
5	RF output 1 (GSM900)
7	RF output 2 (GSM1800)
8	V _{S2} (GSM1800)
10	V _{band}
11	RF input 2 (GSM1800)

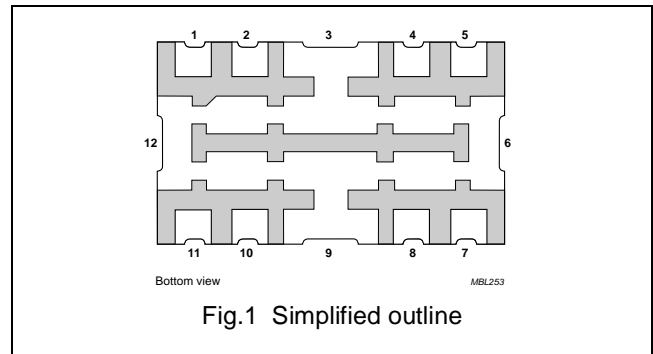

QUICK REFERENCE DATA

RF performance at T_{mb} = 25 °C.

MODE OF OPERATION	f (MHz)	V _S (V)	V _{APC} (V)	P _L (dBm)	η (%)	Z _S , Z _L (Ω)
Pulsed; δ = 1 : 8	880 to 915	3.5	≤2.2	typ. 35	50	50
	1710 to 1785	3.5	≤2.2	typ. 33	45	50

dual band UHF amplifier module for GSM900 and GSM1800

BGY282

LIMITING VALUES

In accordance with the Absolute Maximum Rating System (IEC 60134).

SYMBOL	PARAMETER	CONDITIONS	MIN.	MAX.	UNIT
V _{S1} , V _{S2}	DC supply voltage	V _{APC} = 0; RF _{IN} = off	–	7	V
		V _{APC} > 0.5 V; RF _{IN} = on	–	5.5	V
V _{APC}	DC control voltage		–	3	V
P _{D1} , P _{D2}	input drive power		–	10	dBm
P _{L1}	load power 1 (GSM900)		–	36	dBm
P _{L1}	load power 1 (GSM900)	δ = 4 : 8; VSWR _{out} > 2 : 1	–	35	dBm
P _{L2}	load power 2 (GSM1800)		–	35	dBm
P _{L2}	load power 2 (GSM1800)	δ = 4 : 8; VSWR _{out} > 2 : 1	–	34	dBm
P _{S1}	total power from supply during pulse (GSM900)	δ = 4 : 8	–	7.5	W
P _{S2}	total power from supply during pulse (GSM1800)	δ = 4 : 8	–	4.5	W
T _{stg}	storage temperature		–40	+100	°C
T _{mb}	operating mounting base temperature		–30	+90	°C

Note: P_L is forward power, measured in a coupler.

dual band UHF amplifier module for GSM900 and GSM1800

BGY282

CHARACTERISTICS

$Z_S = Z_L = 50 \Omega$; $P_{D1,2} = 0$ dBm; $V_{S1} = V_{S2} = 3.5$ V; $V_{APC} \leq 2.2$ V; $T_{mb} = 25$ °C; $t_p = 575$ μ s; $\delta = 1 : 8$;
 $f = 880$ to 915 MHz (GSM900); $f = 1710$ to 1785 MHz (GSM1800); measured on demoboard of fig 7; unless otherwise specified.

SYMBOL	PARAMETER	CONDITIONS	MIN.	TYP.	MAX.	UNIT
V_{band}	band switch voltage	GSM1800 selected	0	–	0.7	V
		GSM900 selected	1.7	–	5.5	V
I_{band}	band switch current		–	–	30	μ A
I_L	leakage current	$V_{APC} = 0.2$ V; $P_{D1,2} = 0$ mW	–	–	10	μ A
I_{CM1}, I_{CM2}	peak control current		–	–	2	mA
P_{D1}	input drive power (GSM900)		–3	–	4	dBm
P_{D2}	input drive power (GSM1800)		–3	2	5	dBm
P_{L1}	load power GSM900	$V_{APC} = 2.2$ V	34.7	35	–	dBm
		$V_{APC} = 2.2$ V; $V_{S1} = 3.1$ V	34.2	34.5	–	dBm
P_{L2}	load power GSM1800	$V_{APC} = 2.2$ V	32.3	33	–	dBm
		$V_{APC} = 2.2$ V; $V_{S1} = 3.1$ V	31.7	32.3	–	dBm
η_1	efficiency GSM900	$V_{APC} = 2$ V	43	50	–	%
η_2	efficiency GSM1800	$V_{APC} = 2$ V	38	45	–	%
H_2, H_3	harmonics GSM900	$P_{L1} = 34.7$ dBm	–	–	–38	dBc
	harmonics GSM1800	$P_{L2} = 32.3$ dBm	–	–	–35	dBc
$VSWR_{in}$	input VSWR of active device	$V_{S1,2} = 3.1$ to 4.4 V; $P_{D1,2} = 0$ dBm; $P_{L1} = 5$ to 34.7 dBm; $P_{L2} = 0$ to 32.3 dBm	–	–	3 : 1	
	input VSWR of inactive device	$V_{S1,2} = 3.1$ to 5.15 V; $V_{APC} \leq 0.5$ V	–	–	8 : 1	
	stability	$V_{S1,2} = 3$ to 5 V; $P_{D1} = 0$ to 3 dBm; $P_{D2} = 0$ to 5 dBm; $P_{L1} = <35$ dBm; $P_{L2} = <33$ dBm; $VSWR = 6 : 1$ through all phases	–	–	–60	dBc
		$V_{S1,2} = 3.1$ to 4.2 V; $P_{D1} = 0$ to 3 dBm; $P_{D2} = 0$ to 5 dBm; $P_{L1} = <34$ dBm; $P_{L2} = <32$ dBm; $VSWR = 6 : 1$ through all phases; $\delta = 4 : 8$	–	–	–60	dBc
	isolation	$V_{APC} = 0.5$ V; $P_{D1} = 3$ dBm; $P_{D2} = 5$ dBm	–	–	–36	dBm
	second harmonic isolation from GSM900 into GSM1800	$P_{L1} = 34.7$ dBm	–	–	–20	dBm
	maximum control slope	-5 dBm < $P_{L1,2}$ < P_{Lmax}	120	–	200	dB/V
t_r	carrier rise time	$P_{L1} = 5$ to 34 dBm; $P_{L2} = 0$ to 32 dBm; time to settle within -0.5 dB of final P_L	–	1.5	2	μ s
t_f	carrier fall time	$P_{L1} = 5$ to 34 dBm; $P_{L2} = 0$ to 32 dBm; time to settle within -0.5 dB of final P_L	–	1.5	2	μ s

dual band UHF amplifier module for GSM900 and GSM1800

BGY282

SYMBOL	PARAMETER	CONDITIONS	MIN.	TYP.	MAX.	UNIT
P _n	noise power GSM900	P _{L1} ≤ 34 dBm; bandwidth = 100 kHz; f = 925 MHz	–	–	–71	dBm
		P _{L1} ≤ 34 dBm; bandwidth = 100 kHz; f = 935 MHz	–	–	–80	dBm
	noise power GSM1800	P _{L2} ≤ 32 dBm; bandwidth = 100 kHz; f = 1805 MHz	–	–	–76	dBm
	AM/PM conversion	P _{D1,2} = –0.5 to 0.5 dBm; P _{L1} = 5 to 34 dBm; P _{L2} = 0 to 32 dBm; P _{L1,2} = constant during measurement	–	–	6	deg/dB
	AM/AM conversion	P _{D1,2} = 4 %; f = 100 kHz; P _{L1} = 5 to 34.7 dBm; P _{L2} = 0 to 32.3 dBm	–	–	30	%
CG	conversion gain GSM900	P _{D1} = 0 dBm @ 915 MHz; P _{L1} = 34 dBm; P _{i1} = –50 dBm @ 905 MHz; CG = P ₉₂₅ – P _{i1}	–	25	–	dB
CG	conversion gain GSM1800	P _{D2} = 0 dBm @ 1785 MHz; P _{L2} = 32 dBm; P _{i2} = –50 dBm @ 1765 MHz; CG = P ₁₈₀₅ – P _{i2}	–	25	–	dB
	3 dB control bandwidth GSM900, GSM1800	P _{L1} = 5 to 34 dBm; P _{L2} = 0 to 32 dBm	0.5	–	–	MHz
	power drop 4 slot burst GSM900, GSM1800	V _{APC} = 2.2 V; difference P _L with δ = 1 : 8 and δ = 4 : 8	–	–	0.4	dB
	ruggedness	V _{S1,2} = 5 V; P _{D1} = 0 to 3 dBm; P _{D2} = 0 to 5 dBm; P _{L1} = <35 dBm; P _{L2} = <33 dBm; VSWR ≤ 6 : 1 through all phases	no degradation			
V _{S1,2} = 4.2 V; P _{D1} = 0 to 3 dBm; P _{D2} = 0 to 5 dBm; P _{L1} = <35 dBm; P _{L2} = <33 dBm; VSWR ≤ 10 : 1 through all phases		no degradation				
V _{S1,2} = 4.2 V; P _{D1} = 0 to 3 dBm; P _{D2} = 0 to 5 dBm P _{L1} = <34 dBm; P _{L2} = <32 dBm; VSWR ≤ 6 : 1 through all phases; δ = 4 : 8		no degradation				

dual band UHF amplifier module for GSM900 and GSM1800

BGY282

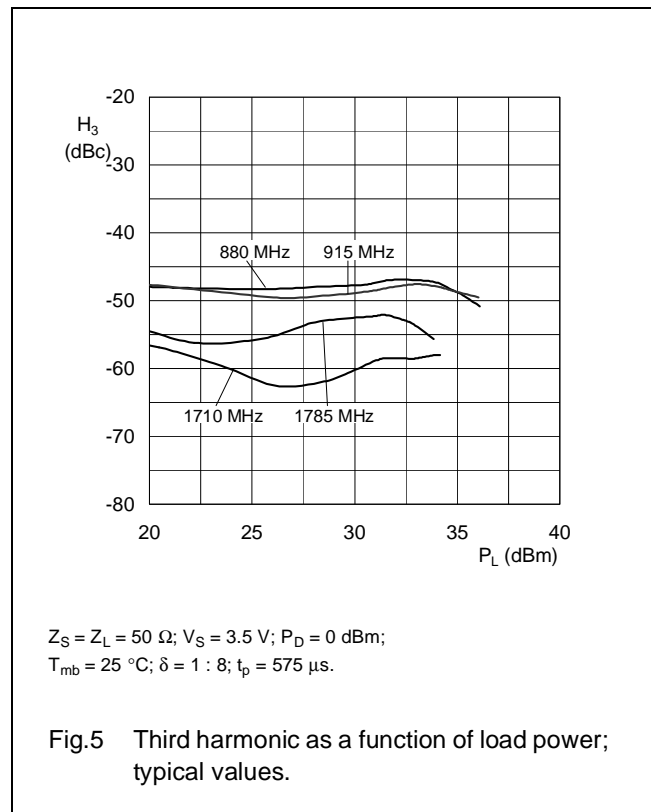
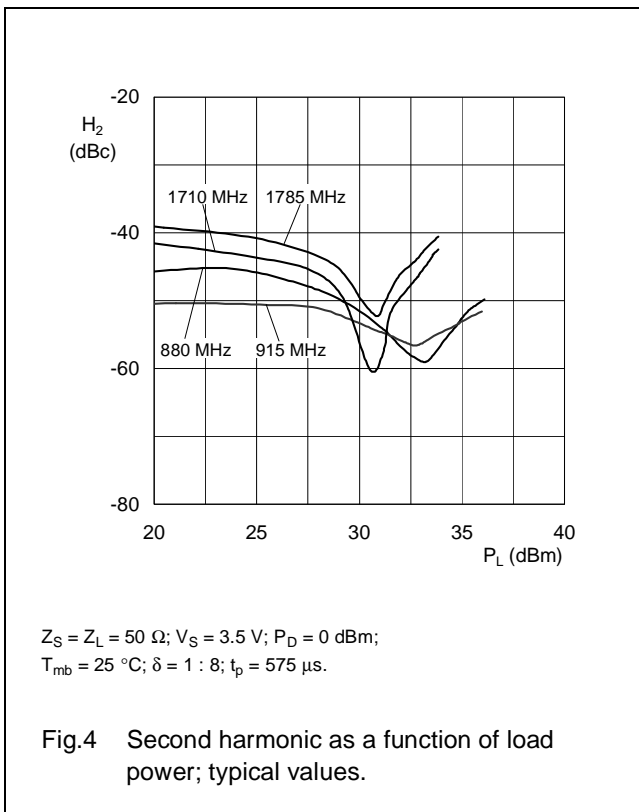
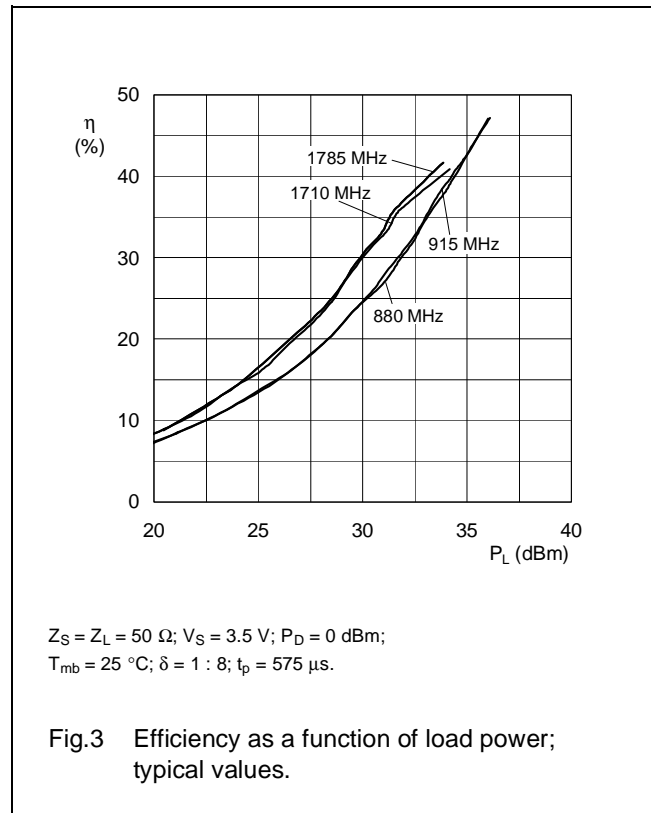
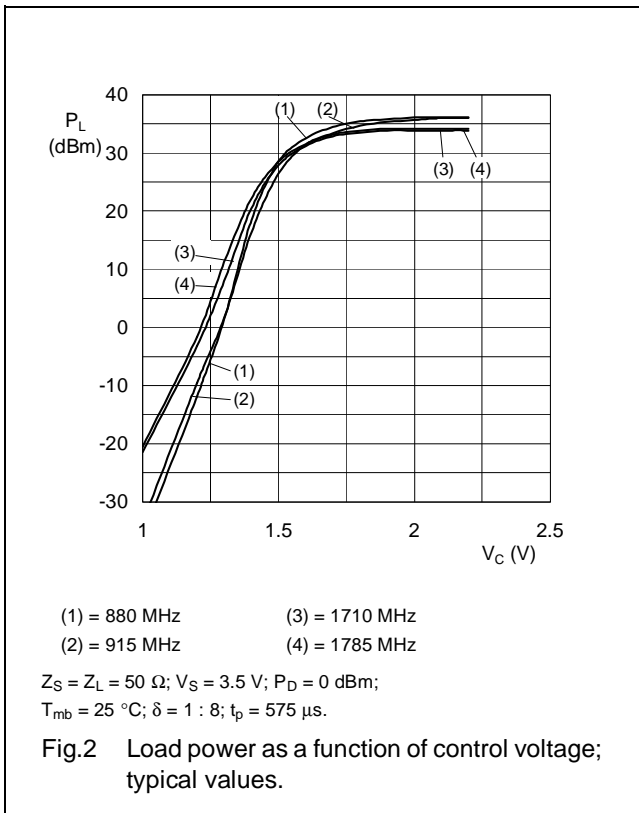

dual band UHF amplifier module for
GSM900 and GSM1800

BGY282

APPLICATION INFORMATION

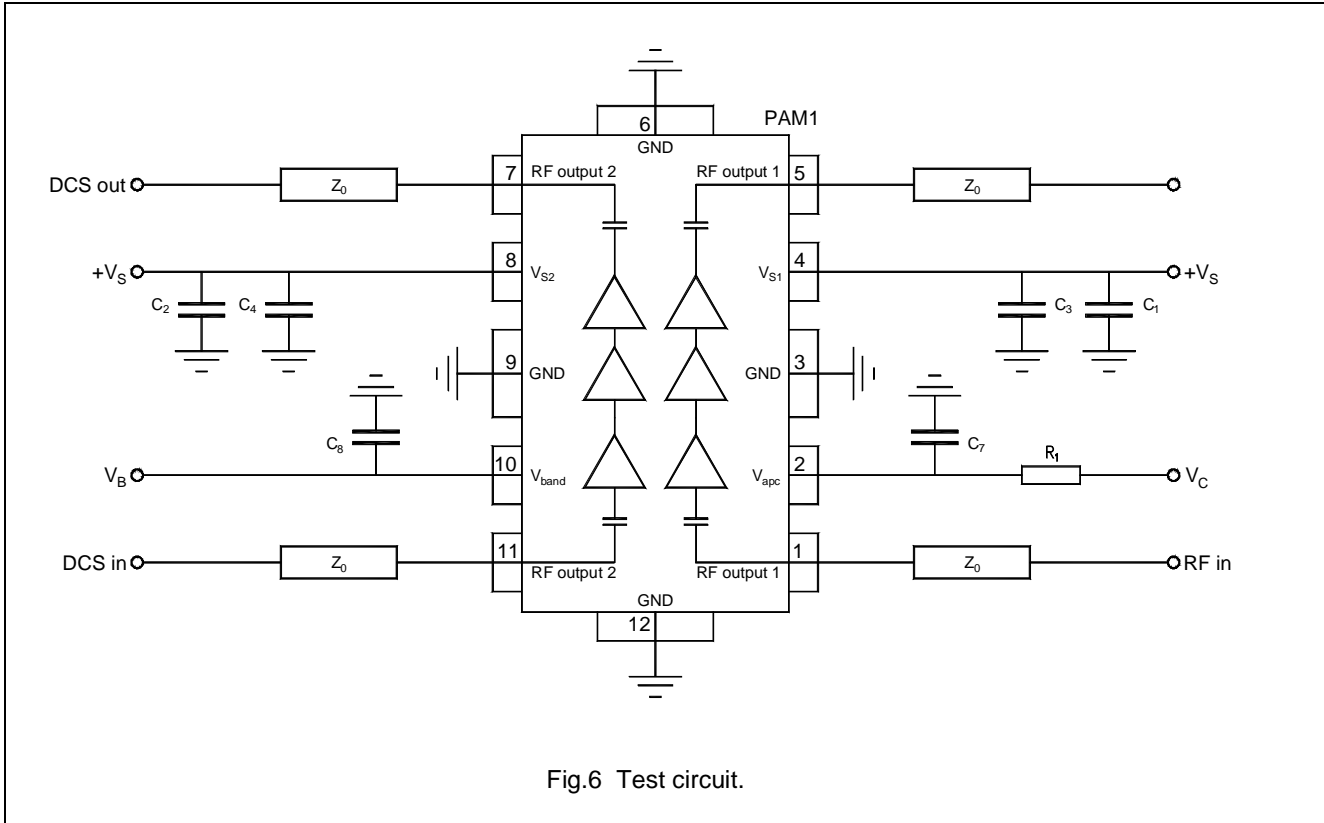

Fig.6 Test circuit.

List of components

QUANTITY	LOCATION	VALUE / TYPE	DESCRIPTION	REMARK	SUPPLIER
1			PCB		Roland Haefele
1	PAM1	BGY282	Power amplifier module		
4			Jack assembly end launch SMA connector	Type no. 142-0701-881	Johnson Components
1	C1	100 μF / 35 V	Electrol. capacitor	Type no. ECEV1VA101P	Matsushita
1	C2	100 μF / 35 V	Electrol. capacitor	Type no. ECEV1VA101P	Matsushita
1	C3	100 nF	0805 size SMD capacitor		
1	C4	100 nF	0805 size SMD capacitor		
1	C7	680 pF	0603 size SMD capacitor		
1	C8	100 pF	0603 size SMD capacitor		
1	R1	100 Ohms / 0.1 W	0805 size SMD resistor		
4	Z0	50 Ω	stripline; note 1	width 1.4 mm	

Note

1. The striplines are on a double etched printed circuit board ($\epsilon_r = 4.6$); thickness 0.8 mm

dual band UHF amplifier module for
GSM900 and GSM1800

BGY282

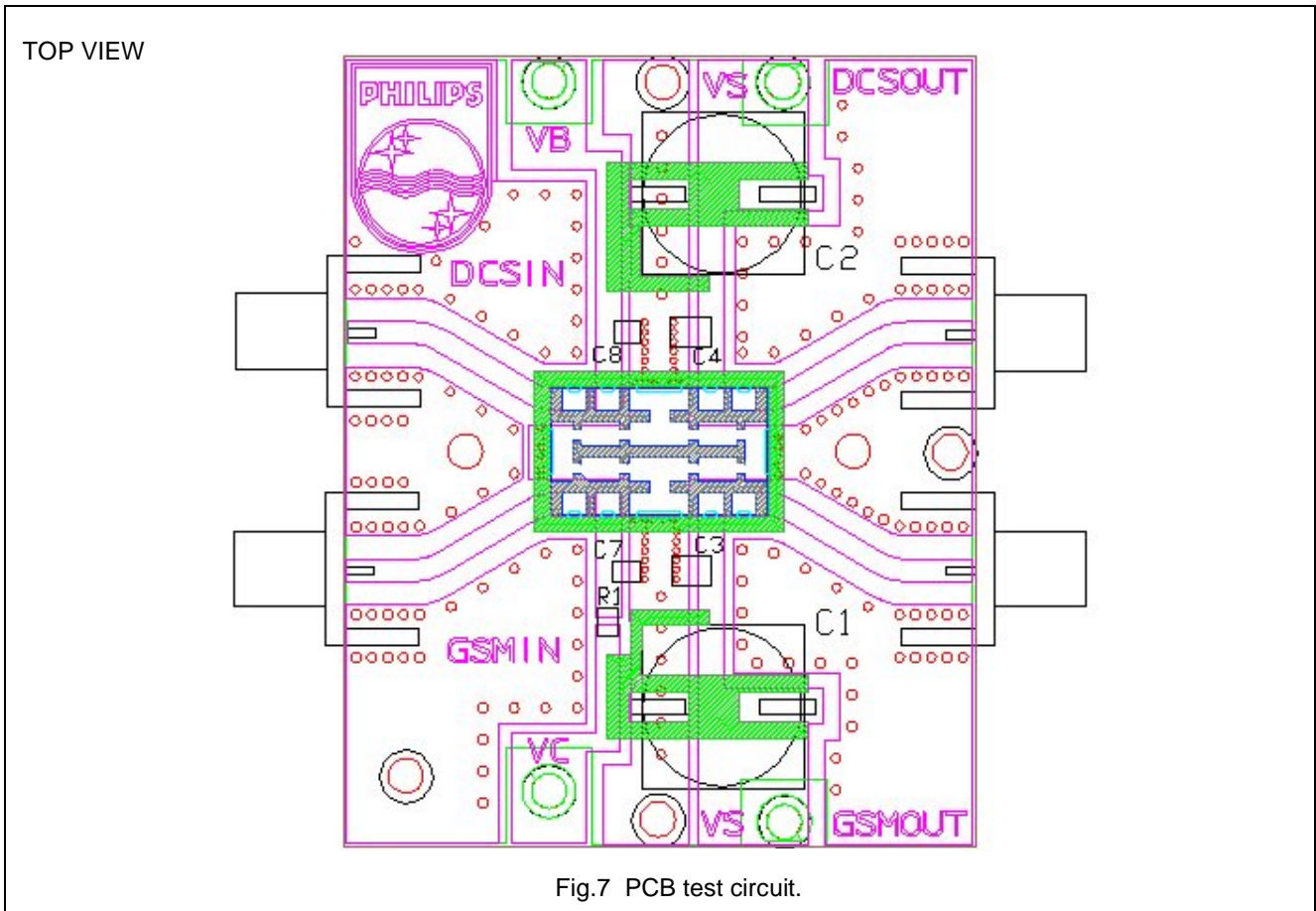

SOLDERING

The indicated temperatures are those at the solder interfaces.

Advised solder types are types with a liquidus less or equal to 210 °C.

Soldering can be carried out using a conveyor oven, a hot air oven, an infrared oven or a combination of these ovens. A double reflow process can be used.

Hand soldering is not recommended because of the nature of the contacts.

The maximum allowed temperature is 250 °C for a maximum of 5 seconds.

The maximum ramp-up is 10 °C per second.

The maximum cool-down is 5 °C per second.

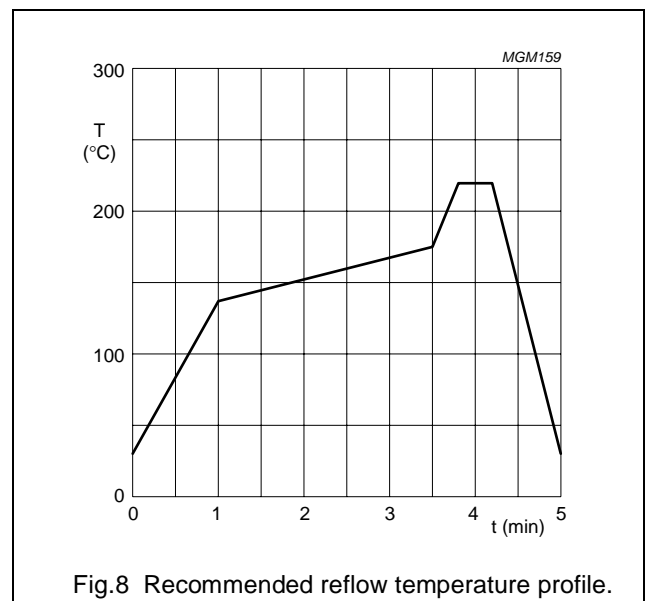

dual band UHF amplifier module for GSM900 and GSM1800

BGY282

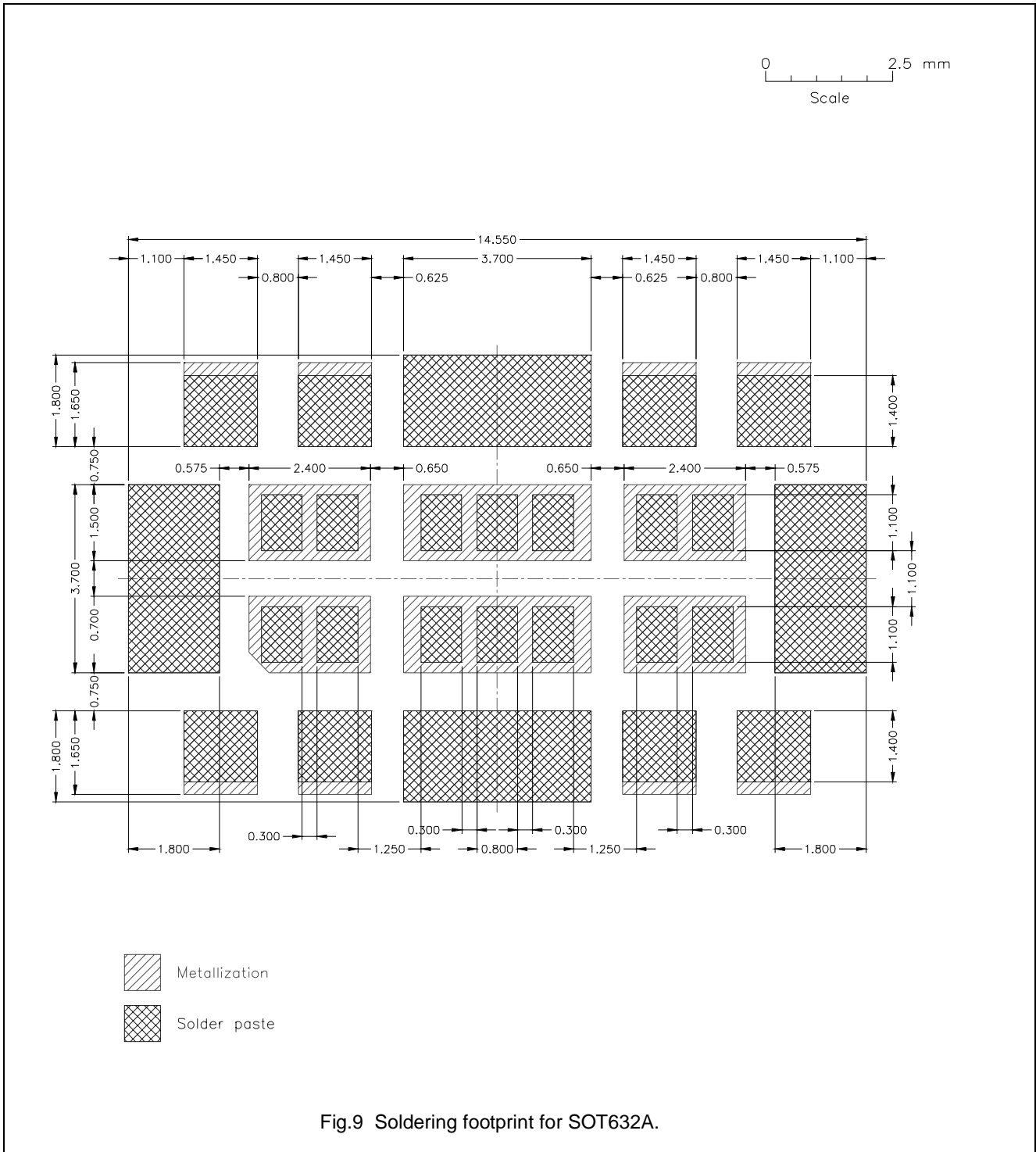

dual band UHF amplifier module for GSM900 and GSM1800

BGY282

PACKAGE OUTLINE

Leadless surface mounted package; plastic cap; 12 terminations

SOT632A

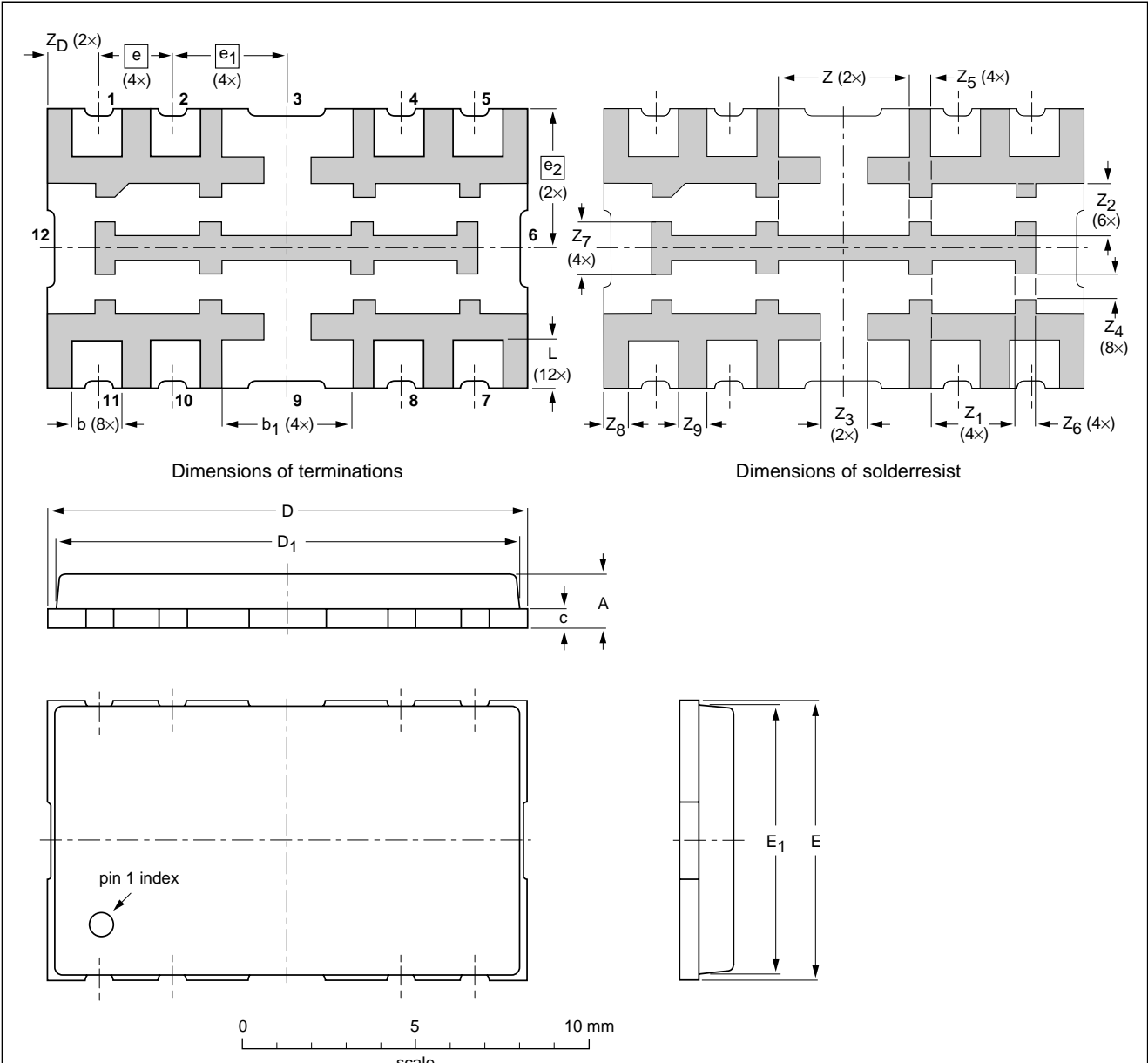

DIMENSIONS (mm are the original dimensions)

UNIT	A	b	b ₁	c	D	D ₁	E	E ₁	e	e ₁	e ₂	L	Z	Z _D	Z ₁	Z ₂	Z ₃	Z ₄	Z ₅	Z ₆	Z ₇	Z ₈	Z ₉
mm	1.8 1.4	1.5 1.4	3.75 3.65	0.61 0.49	14.05 13.45	13.35 13.05	8.3 7.7	7.85 7.55	2.1	3.275	4.0	1.45 1.35	3.75 3.65	1.55 1.45	2.45 2.35	1.55 1.45	1.35 1.25	0.75 0.65	0.7 0.6	0.625 0.525	1.55 1.45	0.75 0.65	0.85 0.75

OUTLINE VERSION	REFERENCES				EUROPEAN PROJECTION	ISSUE DATE
	IEC	JEDEC	EIAJ			
SOT632A						01-09-26 01-11-20

dual band UHF amplifier module for GSM900 and GSM1800

BGY282

DATA SHEET STATUS

DATA SHEET STATUS ⁽¹⁾	PRODUCT STATUS ⁽²⁾	DEFINITIONS
Objective data	Development	This data sheet contains data from the objective specification for product development. Philips Semiconductors reserves the right to change the specification in any manner without notice.
Preliminary data	Qualification	This data sheet contains data from the preliminary specification. Supplementary data will be published at a later date. Philips Semiconductors reserves the right to change the specification without notice, in order to improve the design and supply the best possible product.
Product data	Production	This data sheet contains data from the product specification. Philips Semiconductors reserves the right to make changes at any time in order to improve the design, manufacturing and supply. Changes will be communicated according to the Customer Product/Process Change Notification (CPCN) procedure SNW-SQ-650A.

Notes

1. Please consult the most recently issued data sheet before initiating or completing a design.
2. The product status of the device(s) described in this data sheet may have changed since this data sheet was published. The latest information is available on the Internet at URL <http://www.semiconductors.philips.com>.

DEFINITIONS

Short-form specification — The data in a short-form specification is extracted from a full data sheet with the same type number and title. For detailed information see the relevant data sheet or data handbook.

Limiting values definition — Limiting values given are in accordance with the Absolute Maximum Rating System (IEC 60134). Stress above one or more of the limiting values may cause permanent damage to the device. These are stress ratings only and operation of the device at these or at any other conditions above those given in the Characteristics sections of the specification is not implied. Exposure to limiting values for extended periods may affect device reliability.

Application information — Applications that are described herein for any of these products are for illustrative purposes only. Philips Semiconductors make no representation or warranty that such applications will be suitable for the specified use without further testing or modification.

DISCLAIMERS

Life support applications — These products are not designed for use in life support appliances, devices, or systems where malfunction of these products can reasonably be expected to result in personal injury. Philips Semiconductors customers using or selling these products for use in such applications do so at their own risk and agree to fully indemnify Philips Semiconductors for any damages resulting from such application.

Right to make changes — Philips Semiconductors reserves the right to make changes, without notice, in the products, including circuits, standard cells, and/or software, described or contained herein in order to improve design and/or performance. Philips Semiconductors assumes no responsibility or liability for the use of any of these products, conveys no licence or title under any patent, copyright, or mask work right to these products, and makes no representations or warranties that these products are free from patent, copyright, or mask work right infringement, unless otherwise specified.

Philips Semiconductors – a worldwide company

Contact information

For additional information please visit <http://www.semiconductors.philips.com>. Fax: +31 40 27 24825

For sales offices addresses send e-mail to: sales.addresses@www.semiconductors.philips.com.

© Koninklijke Philips Electronics N.V. 2001

SCA73

All rights are reserved. Reproduction in whole or in part is prohibited without the prior written consent of the copyright owner.

The information presented in this document does not form part of any quotation or contract, is believed to be accurate and reliable and may be changed without notice. No liability will be accepted by the publisher for any consequence of its use. Publication thereof does not convey nor imply any license under patent- or other industrial or intellectual property rights.

Printed in The Netherlands

budgetnum/printrun/ed/pp12

Date of release: 2001 Dec 04

Document order number: 9397 750 09163

Let's make things better.

**Philips
Semiconductors**



PHILIPS