

3-terminal Dropper Type Regulator SI-3003S

Features

- 3-terminal IC regulator with 0.8A output current
- Voltage accuracy of $\pm 2\%$
- Low Dropout voltage $\leq 0.5V$ at $I_O \leq 0.5A$, $\leq 1V$ at $I_O \leq 0.8A$
- Built-in constant current type overcurrent, overvoltage and thermal protection circuits
- TO-220 equivalent full-mold package

Absolute Maximum Ratings

($T_a = 25^\circ C$)

Parameter	Symbol	Ratings	Unit	Conditions
DC input voltage	V_{IN}	35	V	
Output current	I_O	0.8 *2	A	
Power Dissipation	P_{D1}	22	W	With infinite heatsink
	P_{D2}	1.8	W	Stand-alone without heatsink
Junction temperature	T_J	-40 to +150	$^\circ C$	
Operating temperature	T_{OP}	-40 to +100	$^\circ C$	
Storage temperature	T_{stg}	-40 to +150	$^\circ C$	
Junction to case thermal resistance	θ_{j-c}	5.5	$^\circ C/W$	
Junction to ambient-air thermal resistance	θ_{j-a}	66.7	$^\circ C/W$	Stand-alone without heatsink

External Dimensions (unit: mm)

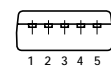
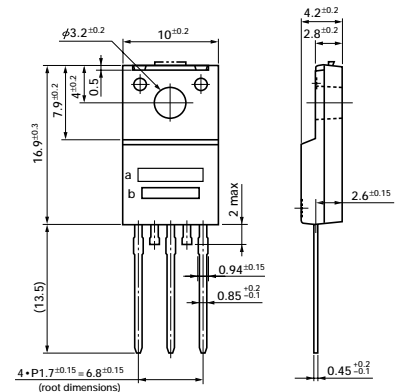

- Terminal connections
1. V_{IN}
 2. (NC)
 3. GND
 4. (NC)
 5. V_O
- a: Type No.
b: Lot No.
(Forming No. 1115)

Electrical Characteristics

($T_J = 25^\circ C$, $V_{IN} = 14V$, $I_O = 0.5A$ unless otherwise specified)

Parameter	Symbol	Ratings			Unit	Conditions
		min	typ	max		
Input voltage	V_{IN}	6*2		30*1	V	
Output voltage	V_O	4.90	5.00	5.10	V	
Dropout voltage	V_{DIF}			0.5	V	$I_O \leq 0.5A$
				1.0	V	$I_O \leq 0.8A$
Line regulation	$\Delta V_{O LINE}$			30	mV	$V_{IN} = 8$ to $16V$
Load regulation	$\Delta V_{O LOAD}$			100	mV	$I_O = 0$ to $0.5A$
Ripple rejection	R_{REJ}		54		dB	$f = 100$ to $120Hz$
Quiescent circuit current	I_Q		3	10	mA	$I_O = 0A$
Overcurrent protection starting current	I_{S1}	0.9*3			A	

Notes:

- *1. Since $P_D(max) = (V_{IN} - V_O) \cdot I_O = 22(W)$, $V_{IN}(max)$ and $I_O(max)$ may be limited depending on operating conditions. Refer to the $T_a - P_D$ curve to compute the corresponding values.
- *2. Refer to the dropout voltage.
- *3. I_{S1} rating shall be the point at which the output voltage V_O ($V_{IN} = 14V$, $I_O = 0.5A$) drops to -5%.

Equivalent Circuit Diagram

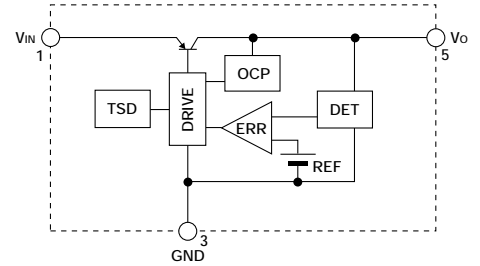

Standard Circuit Diagram

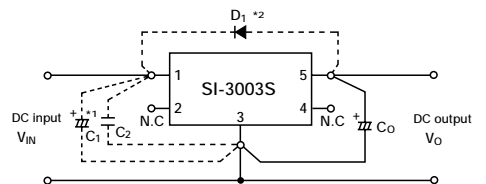

C_O : Output capacitor (47 to 100 μF , 50V)

*1 C_1, C_2 : Anti-oscillation capacitors (C_1 : approx. 47 μF , C_2 : approx. 0.33 μF). These are required for inductive input lines or long wiring. Tantalum capacitors are recommended for C_1 and C_2 , especially at low temperatures.

*2 D_1 : Protection diode. Required as protection against reverse biasing between input and output.
(Recommended diode: Sanken EU2Z.)

■ I_o vs V_{DIF} Characteristics

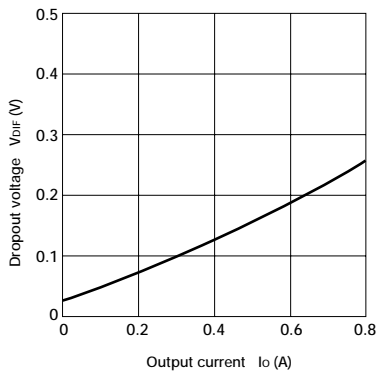

■ Line Regulation

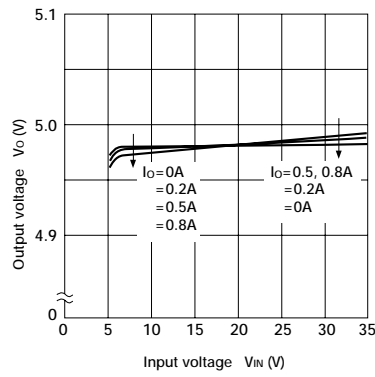

■ Load Regulation

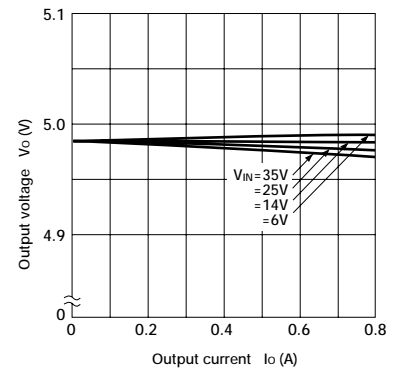

■ Output Voltage Temperature Characteristics

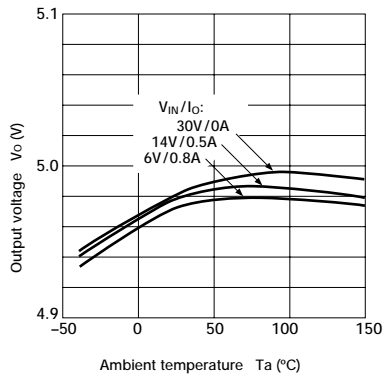

■ Rise Characteristics

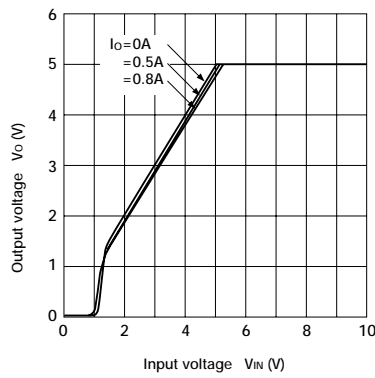

■ Circuit Current

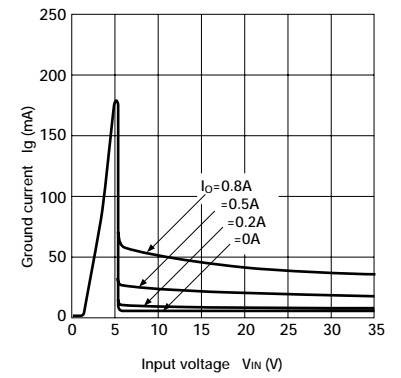

■ Overcurrent Protection Characteristics

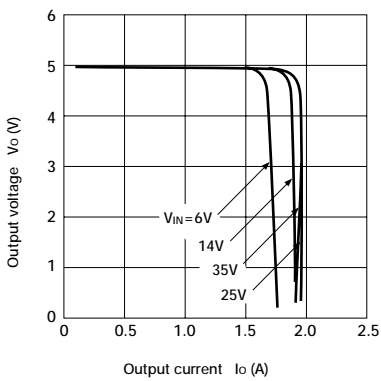

■ Thermal Protection Characteristics

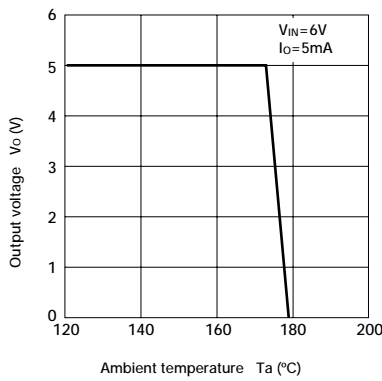

■ $T_a - P_D$ Characteristics

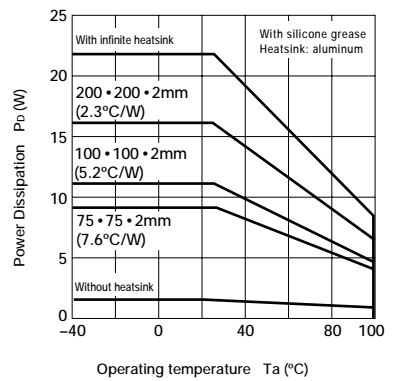

Note on Thermal Protection Characteristics:
The thermal protection circuit is intended for protection against heat during instantaneous short-circuiting. Its operation, including reliability, is not guaranteed for short-circuiting over an extended period of time.