

# SBD Type : EC30HA04

OUTLINE DRAWING

構造 : 表面実装型、ショットキバリアダイオード(SBD)  
 Construction: Surface Mounting, Schottky Barrier Diode

用途 : 高周波整流用  
 Application : High Frequency Rectification

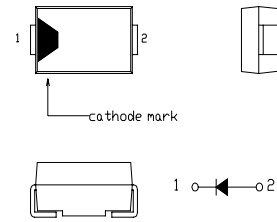

## 最大定格 / Maximum Ratings

Approx Net Weight:0.06g

Rating	Symbol	EC30HA04		Unit
くり返しピーク逆電圧 Repetitive Peak Reverse Voltage	$V_{RRM}$	40		V
くり返しピークサージ逆電圧 Repetitive peak surge reverse voltage	$V_{RRSM}$	45	パルス幅1us以下、デューティー1/50以下 Pulse width 1us、Duty 1/50	V
平均整流電流 Average Rectified Output Current	$I_O$	1.69	Ta=25 *1 50Hz、正弦半波通電 Half Sine Wave	A
		3.0	TI=96 (TI:Lead Temperature) 抵抗負荷 Resistive Load	A
実効順電流 RMS Forward Current	$I_{F(RMS)}$	4.71		A
サージ順電流 Surge Forward Current	$I_{FSM}$	60	50 Hz 正弦半波, 1サイクル, 非くり返し Half Sine Wave, 1cycle, Non-repetitive	A
動作接合温度範囲 Operating Junction Temperature Range	Tjw	- 40 ~ + 150		
保存温度範囲 Storage Temperature Range	Tstg	- 40 ~ + 150		

## 電氣的・熱的特性 / Electrical・Thermal Characteristics

Characteristics	Symbol	Conditions	Min.	Typ.	Max.	Unit
ピーク逆電流 Peak Reverse Current	$I_{RM}$	Tj=25 , $V_{RM} = V_{RRM}$	-	-	500	$\mu A$
ピーク順電圧 Peak Forward Voltage	$V_{FM}$	Tj=25 , $I_{FM} = 3 A$	-	-	0.59	V
熱抵抗 Thermal Resistance	接合部・周囲間 Junction to Ambient	Rth(j-a) Alumina Substrate Mounted *1	-	-	108	/W
	接合部・リード間 Junction to Lead	Rth(j-l) -	-	-	23	/W

\*1:アルミナ基板実装/Alumina Substrate mounted (Soldering Lands= 2 × 2 mm , Both Sides)

EC30HA\_ 外形図 (単位: mm)

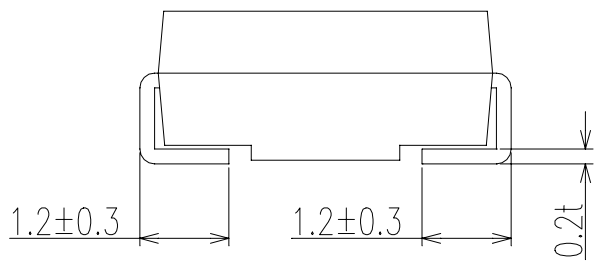
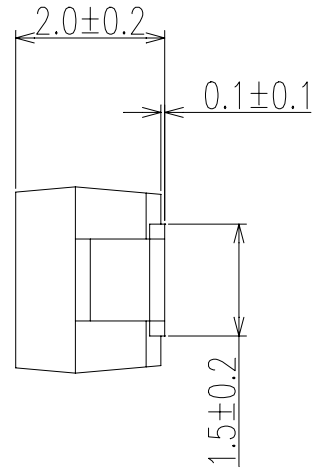
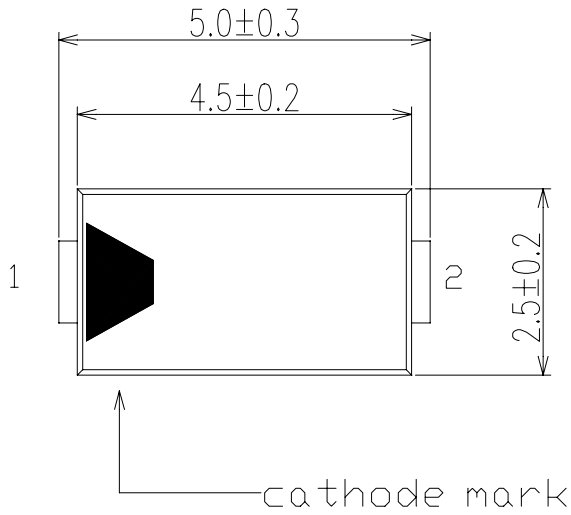

SOLDERING PAD

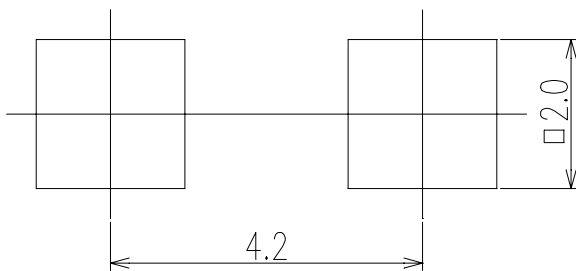

順電壓特性  
FORWARD CURRENT VS. VOLTAGE

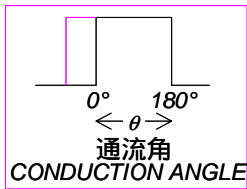
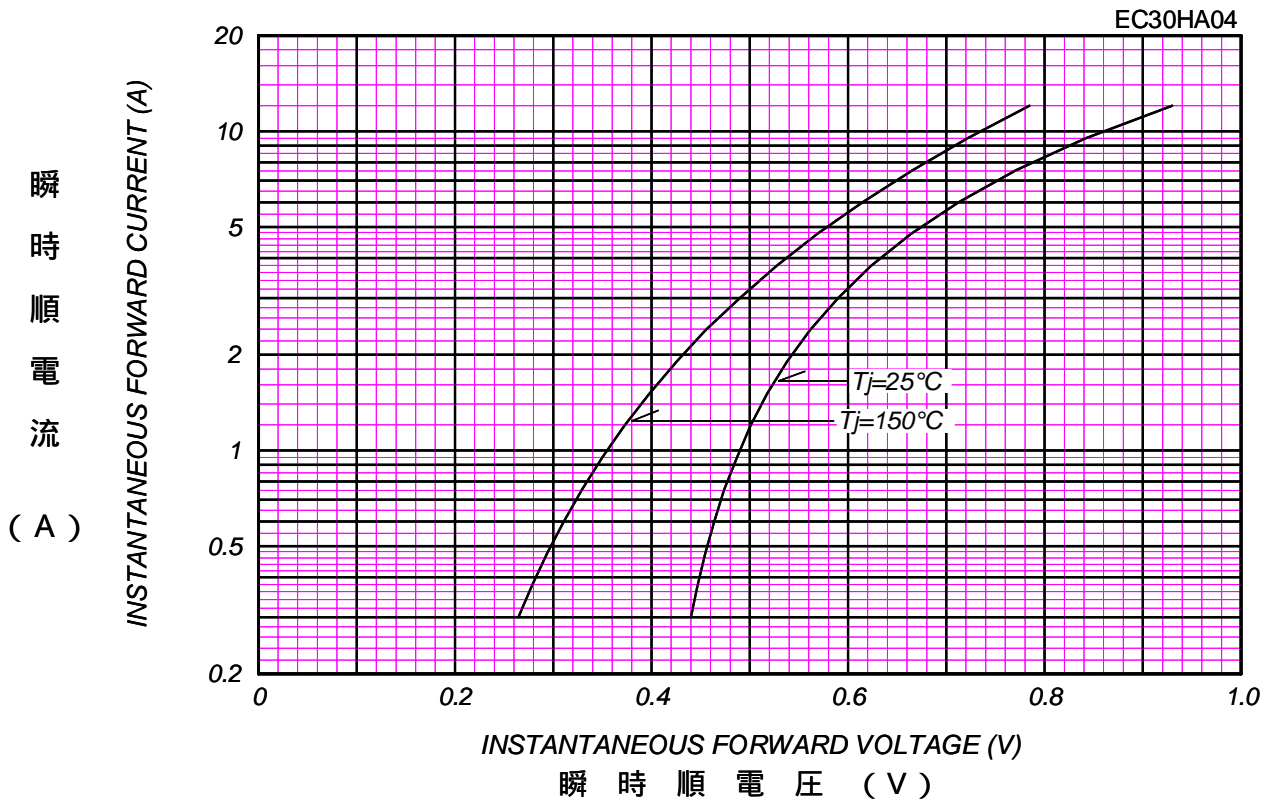

平均順電力損失特性  
AVERAGE FORWARD POWER DISSIPATION

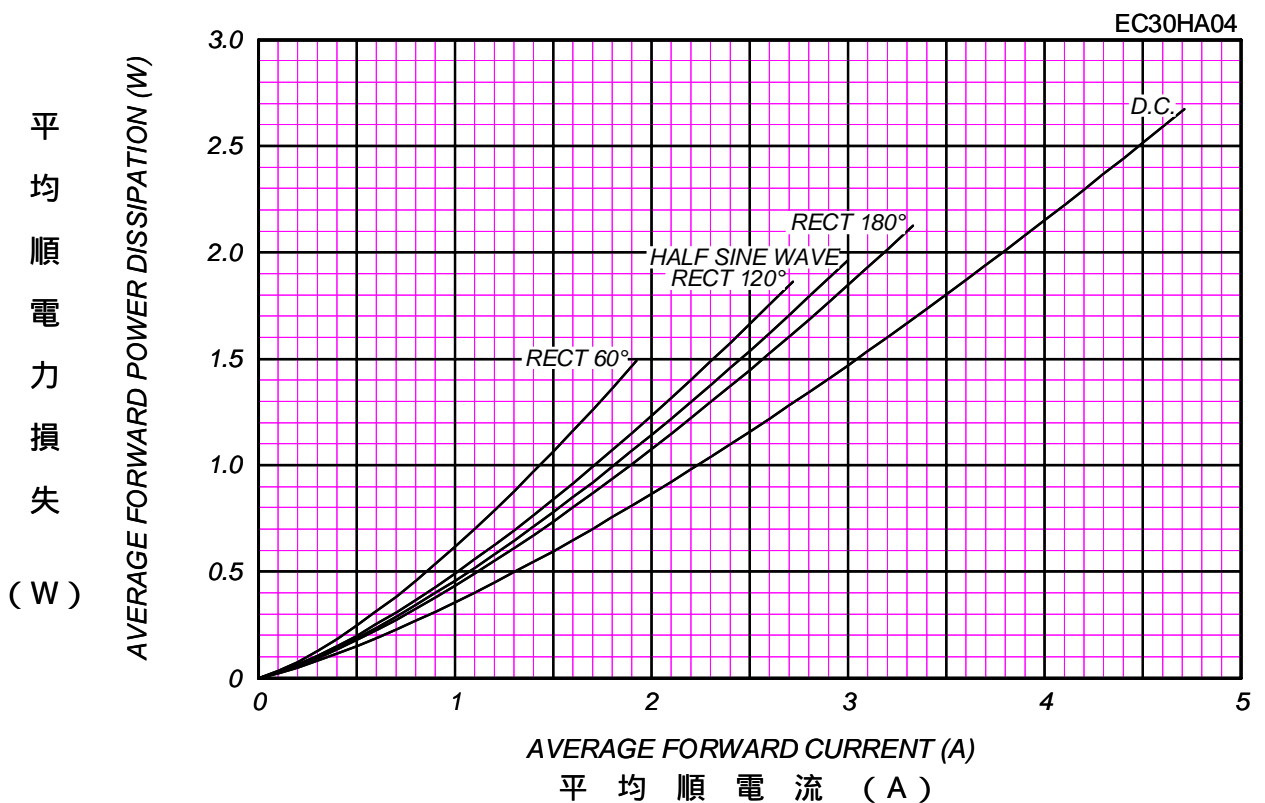

ピーク逆電流 - ピーク逆電圧特性  
 PEAK REVERSE CURRENT VS. PEAK REVERSE VOLTAGE

T<sub>j</sub> = 150 °C

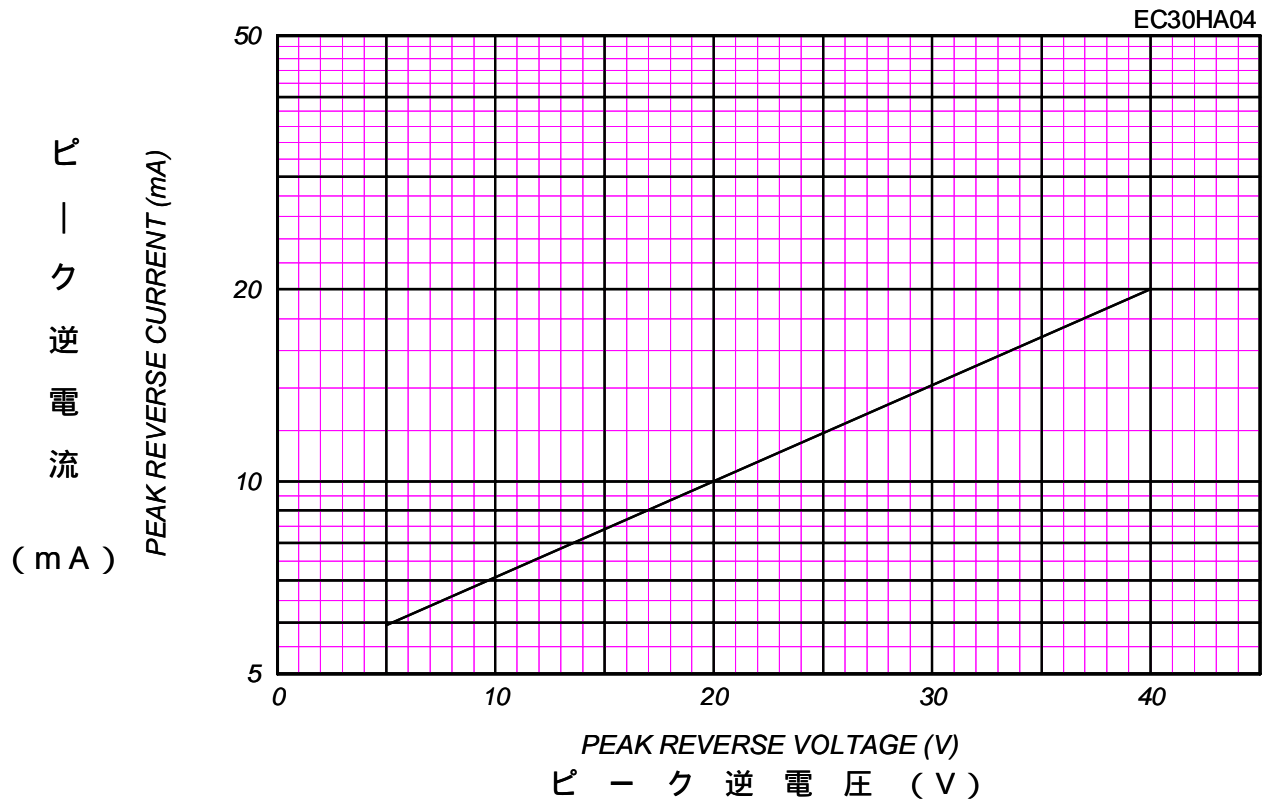

平均逆電力損失  
 AVERAGE REVERSE POWER DISSIPATION

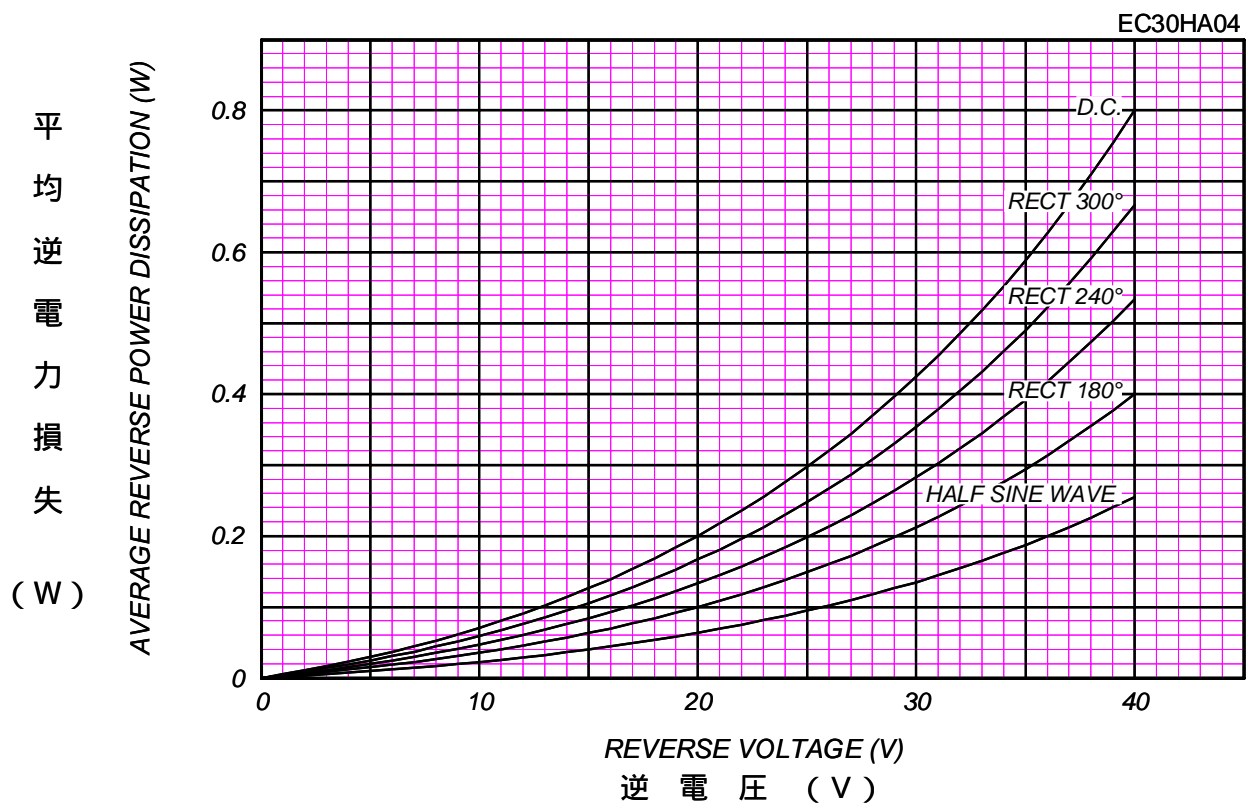

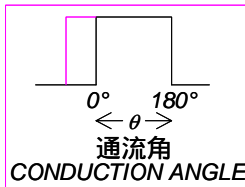

平均順電流 - 周囲温度定格  
 AVERAGE FORWARD CURRENT VS. AMBIENT TEMPERATURE

Alumina Substrate Mounted (Soldering Land=2x2mm),  $V_{RM}=40V$

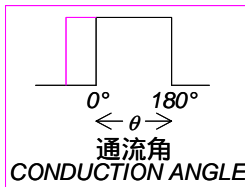
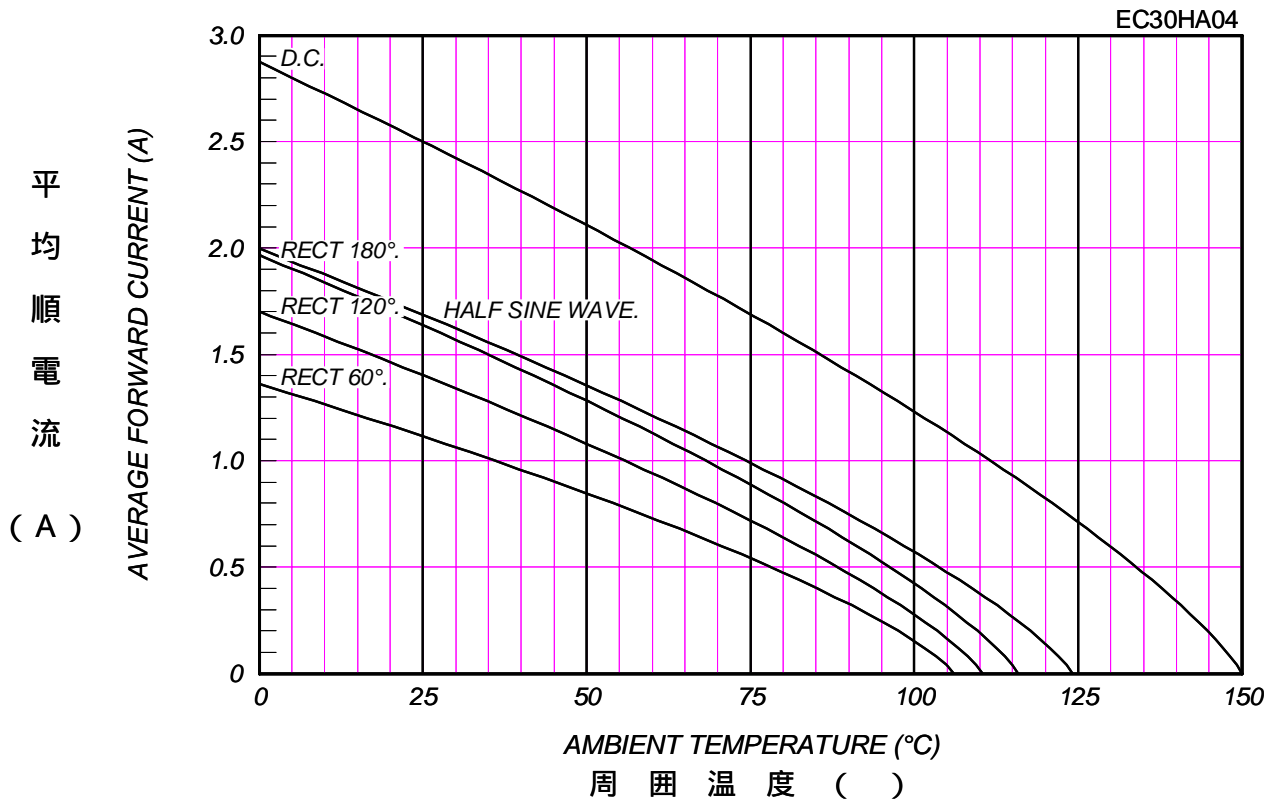

平均順電流 - リード温度定格  
 AVERAGE FORWARD CURRENT VS. LEAD TEMPERATURE

$V_{RM}=40V$

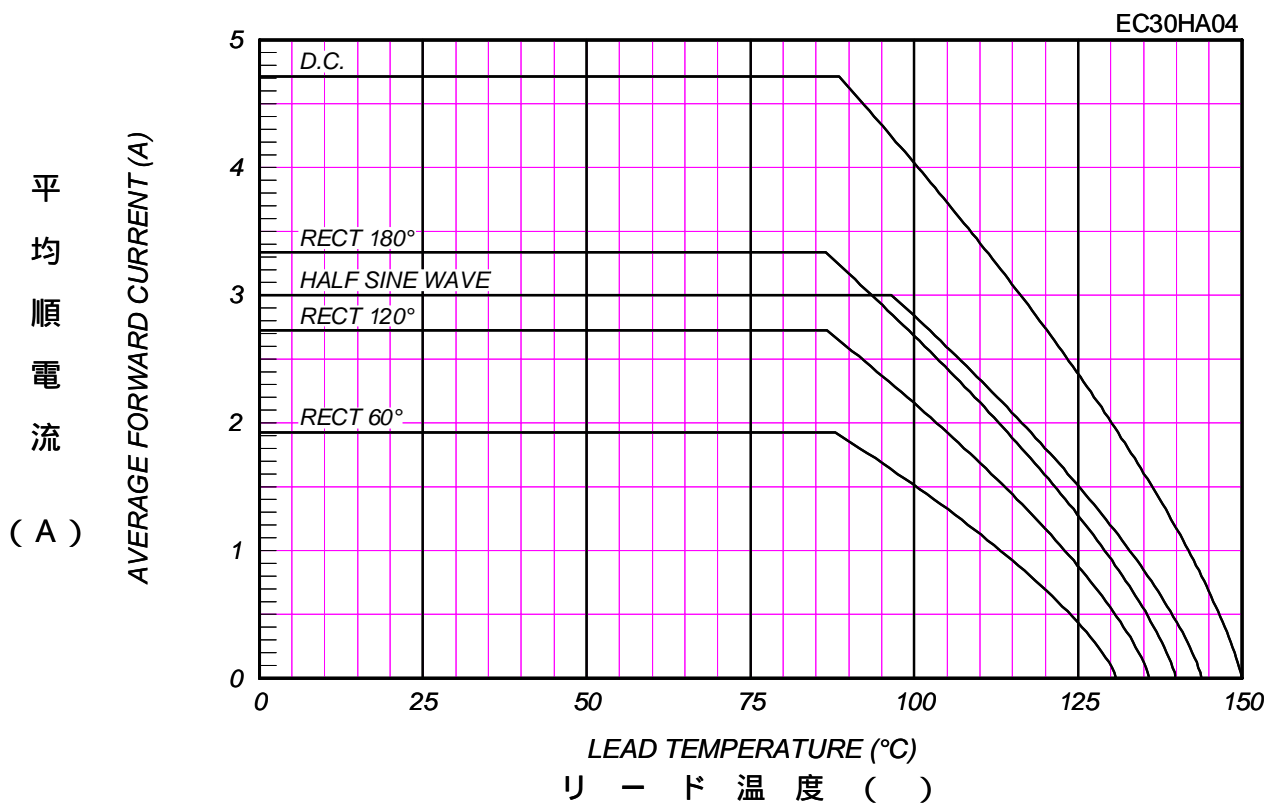

# サージ順電流定格 SURGE CURRENT RATINGS

f=50Hz, Half Sine Wave, Non-Repetitive, No Load

EC30HA04

サ  
ー  
ジ  
順  
電  
流  
  
(A)

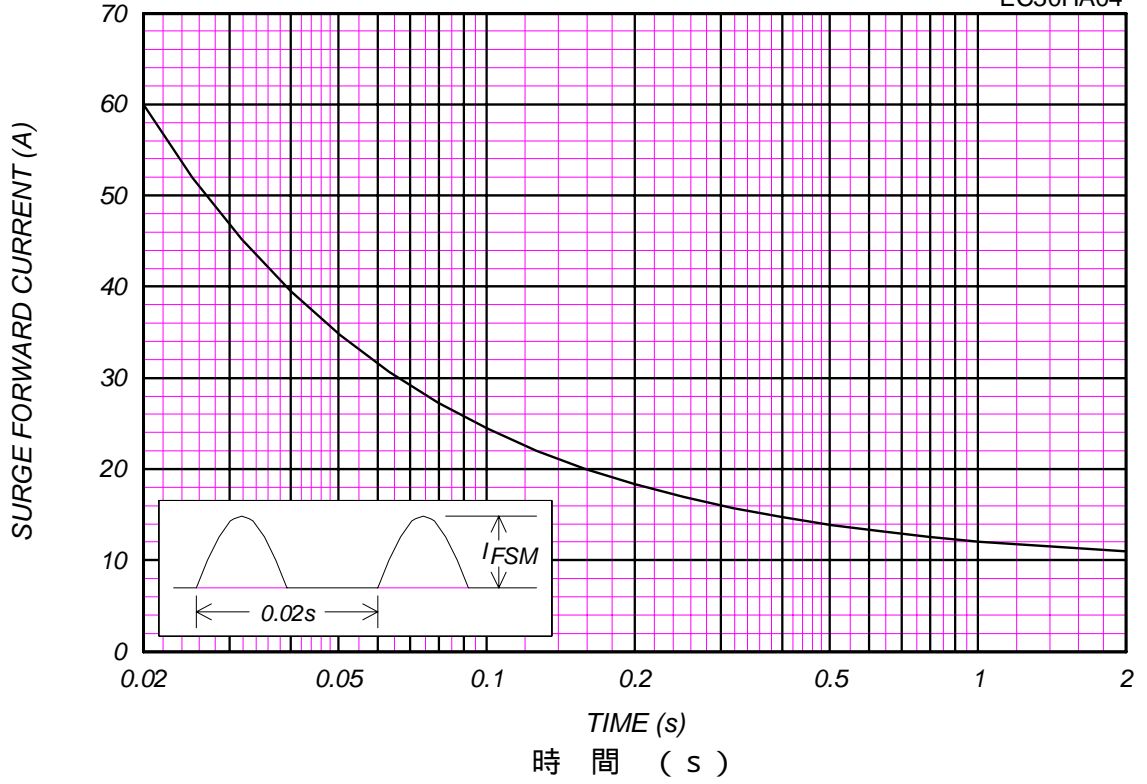

# 接合容量特性 JUNCTION CAPACITANCE VS. REVERSE VOLTAGE

T<sub>j</sub>=25°C, V<sub>m</sub>=20mV<sub>RMS</sub>, f=100kHz, Typical Value

EC30HA04

接  
合  
容  
量  
  
(pF)

