

MITSUBISHI INSULATED GATE BIPOLAR TRANSISTOR

CT20VM-8

STROBE FLASHER USE

CT20VM-8



- V_{CES} 400V
- I_{CM} 130A

OUTLINE DRAWING Dimensions in mm

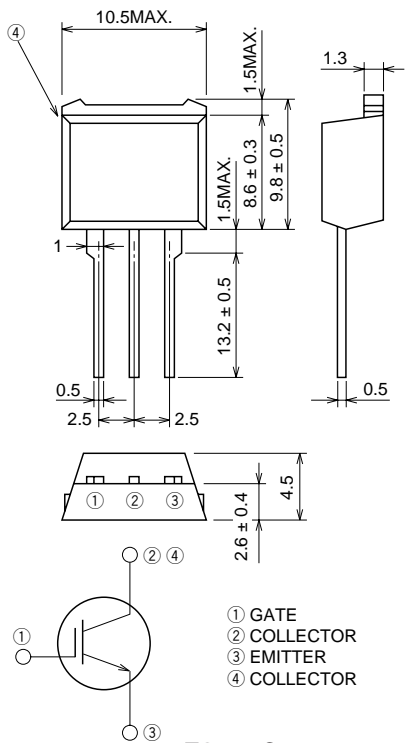

① GATE
② COLLECTOR
③ EMITTER
④ COLLECTOR

TO-220C

APPLICATION
Strobe Flasher.

MAXIMUM RATINGS ($T_c = 25^\circ\text{C}$)

Symbol	Parameter	Conditions	Ratings	Unit
V_{CES}	Collector-emitter voltage	$V_{GE} = 0V$	400	V
V_{GES}	Gate-emitter voltage	$V_{CE} = 0V$, See notice 4	± 30	V
V_{GEM}	Peak gate-emitter voltage	$V_{CE} = 0V$, $t_w = 0.5s$	± 40	V
I_{CM}	Collector current (Pulsed)	See figure 1	130	A
T_j	Junction temperature		$-40 \sim +150$	$^\circ\text{C}$
T_{stg}	Storage temperature		$-40 \sim +150$	$^\circ\text{C}$

ELECTRICAL CHARACTERISTICS ($T_j = 25^\circ\text{C}$)

Symbol	Parameter	Test conditions	Limits			Unit
			Min.	Typ.	Max.	
$V_{(BR)CES}$	Collector-emitter breakdown voltage	$I_C = 1mA$, $V_{GE} = 0V$	450	—	—	V
I_{CES}	Collector-emitter leakage current	$V_{CE} = 400V$, $V_{GE} = 0V$	—	—	10	μA
I_{GES}	Gate-emitter leakage current	$V_{GE} = \pm 40V$, $V_{CE} = 0V$	—	—	± 0.1	μA
$V_{GE(th)}$	Gate-emitter threshold voltage	$V_{CE} = 10V$, $I_C = 1mA$	—	—	7.0	V

PERFORMANCE CURVES

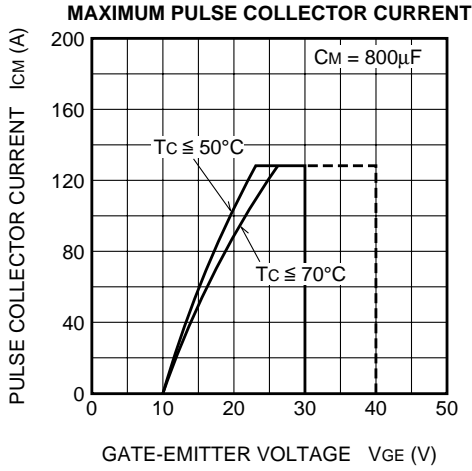

Figure 1

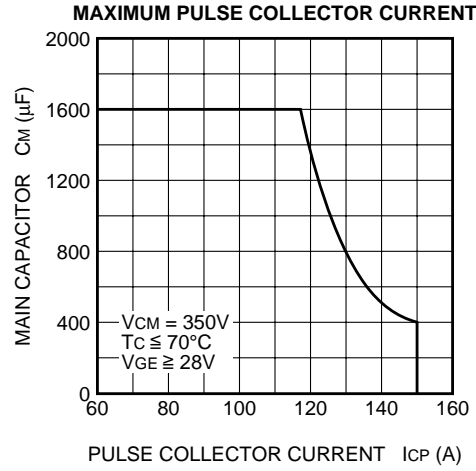
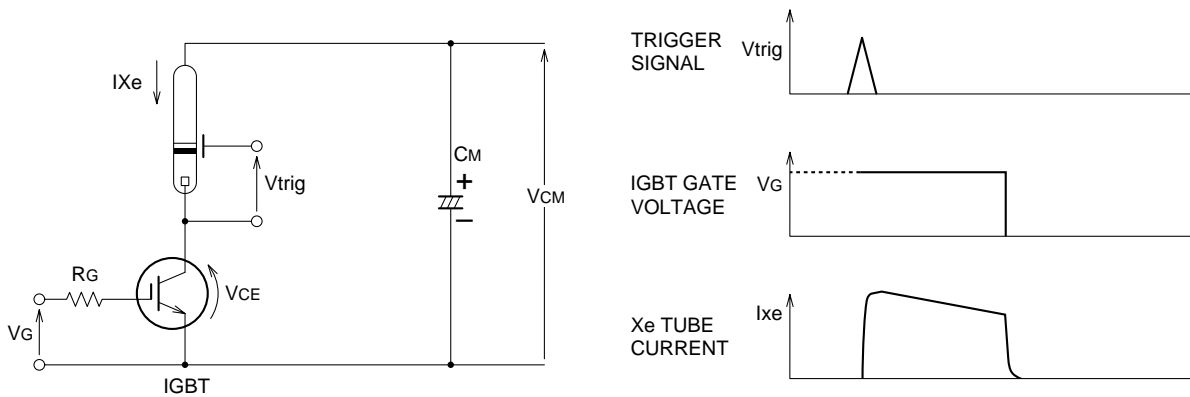

Figure 2

APPLICATION EXAMPLE



RECOMMEND CONDITION	MAXIMUM CONDITION
V _{CM} = 330V	360V
I _P = 120A	130A
C _M = 700µF	800µF
V _{GE} = 28V	

- Notice 1. Gate drive voltage during on-period must be applied to satisfy the rating of maximum pulse collector current. And reverse gate current during turn-off must be kept less than 1A. (In general, it is satisfied if R_G ≥ 30Ω)
- Notice 2. IGBT has MOS structure and its gate is insulated by thin silicon oxide. So please handle carefully not to suffer from electrostatic charge.
- Notice 3. The operation life should be endured 5,000 shots under the charge current (I_xe ≤ 130A : full luminescence condition) of main condenser (C_M=800µF). Repetition period under full luminescence condition is over 3 seconds.
- Notice 4. Total operation hours must be applied within 5,000 hours.