

**HIGH FREQUENCY AMPLIFIER AND SWITCHING
PNP SILICON EPITAXIAL TRANSISTOR
MINI MOLD**

PACKAGE DIMENSIONS

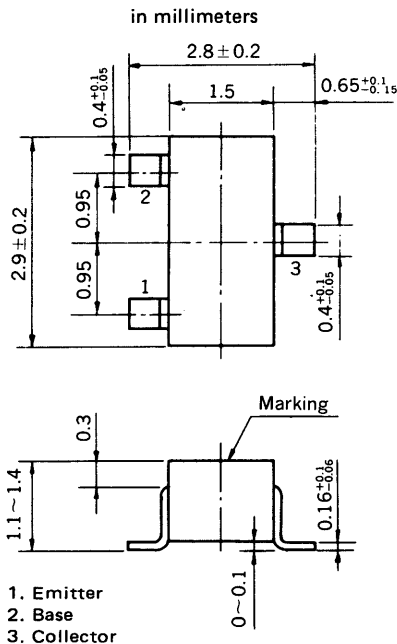

FEATURES

- High Speed Switching: $t_{stg} = 110$ ns
- High Gain Bandwidth Product : $f_T = 510$ MHz
- Complementary to 2SC3734

ABSOLUTE MAXIMUM RATINGS

Maximum Voltages and Current ($T_a = 25^\circ\text{C}$)

Collector to Base Voltage	V_{CBO}	-40	V
Collector to Emitter Voltage	V_{CEO}	-40	V
Emitter to Base Voltage	V_{EBO}	-5	V
Collector Current (DC)	I_C	-200	mA

Maximum Power Dissipation

Total Power Dissipation at 25°C Ambient Temperature	P_T	200	mW
--	-------	-----	----

Maximum Temperatures

Junction Temperature	T_j	150	$^\circ\text{C}$
Storage Temperature Range	T_{stg}	-55 to +150	$^\circ\text{C}$

ELECTRICAL CHARACTERISTICS ($T_a = 25^\circ\text{C}$)

CHARACTERISTIC	SYMBOL	MIN.	TYP.	MAX.	UNIT	TEST CONDITIONS
Collector Cutoff Current	I_{CBO}			-100	nA	$V_{CB} = -30$ V, $I_E = 0$
Emitter Cutoff Current	I_{EBO}			-100	nA	$V_{EB} = -3.0$ V, $I_C = 0$
DC Current Gain	h_{FE1}^*	75	180	300		$V_{CE} = -1.0$ V, $I_C = -10$ mA
DC Current Gain	h_{FE2}^*	25	100			$V_{CE} = -10$ V, $I_C = -100$ mA
Collector Saturation Voltage	$V_{CE(sat)}^*$		-0.1	-0.4	V	$I_C = -50$ mA, $I_B = -5.0$ mA
Base Saturation Voltage	$V_{BE(sat)}^*$		-0.8	-0.95	V	$I_C = -50$ mA, $I_B = -5.0$ mA
Gain Bandwidth Product	f_T	200	510		MHz	$V_{CE} = -20$ V, $I_E = 10$ mA
Output Capacitance	C_{ob}		2.5	4.5	pF	$V_{CB} = -5.0$ V, $I_E = 0$, $f = 1.0$ MHz
Turn-on Time	t_{on}			70	ns	$V_{CC} = -3.0$ V
Storage Time	t_{stg}		110	225	ns	$I_C = -10$ mA
Turn-off Time	t_{off}			300	ns	$I_{B1} = -I_{B2} = -1.0$ mA

* Pulsed: $PW \leq 350$ μ s, Duty Cycle ≤ 2 %

h_{FE} Classification

MARKING	Y22	Y23	Y24
h_{FE1}	75 to 150	100 to 200	150 to 300

SWITCHING TIME TEST CIRCUIT

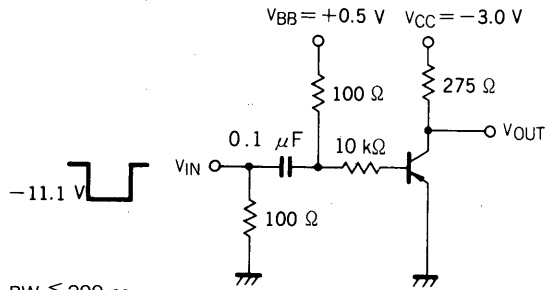

$PW \leq 300$ ns
 $t_r < 1.0$ ns
 $Z_{IN} = 50 \Omega$
 Duty Cycle = 2 %

t_{on} SWITCHING

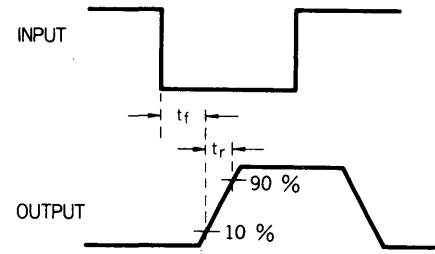

VOLTAGE WAVEFORMS

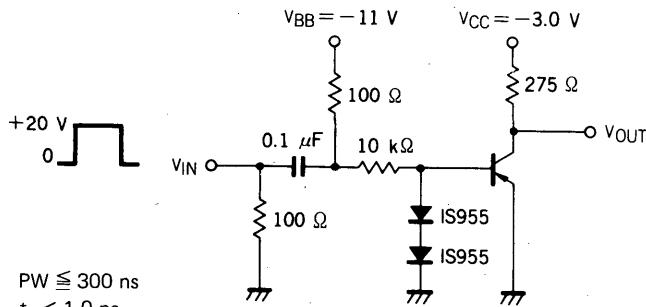

$PW \leq 300$ ns
 $t_r < 1.0$ ns
 Duty Cycle = 2 %

t_{off} SWITCHING

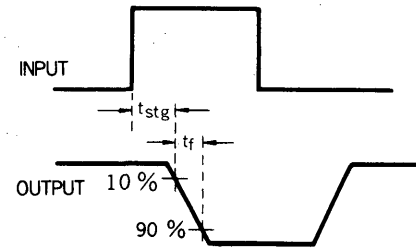

VOLTAGE WAVEFORMS

TYPICAL CHARACTERISTICS ($T_a = 25^\circ C$)

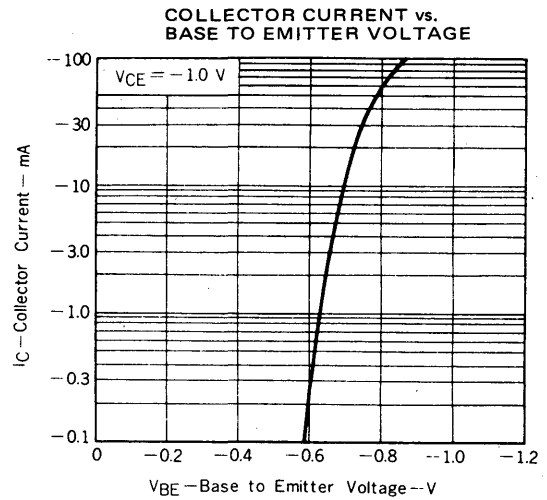
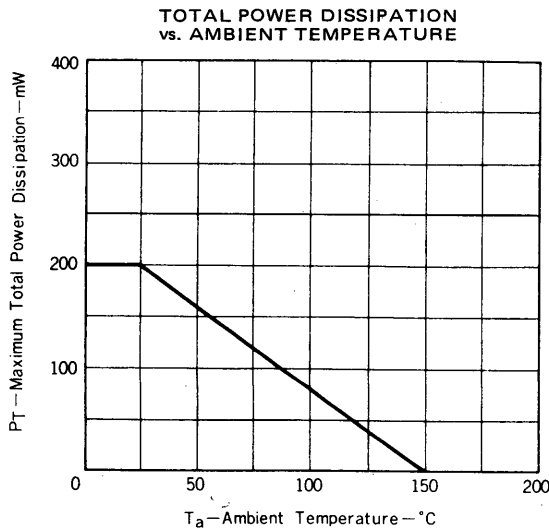

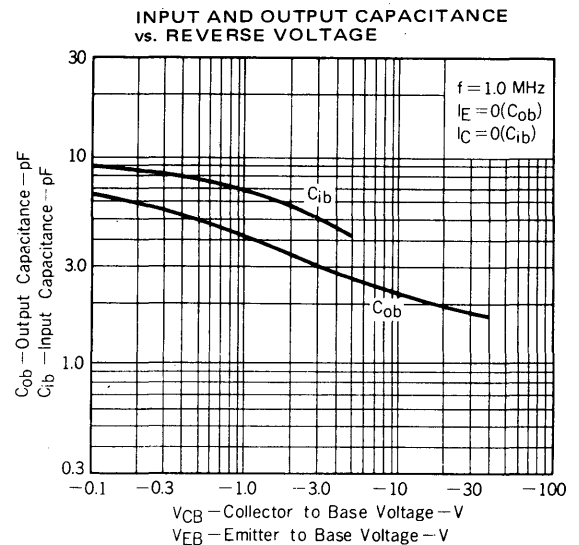
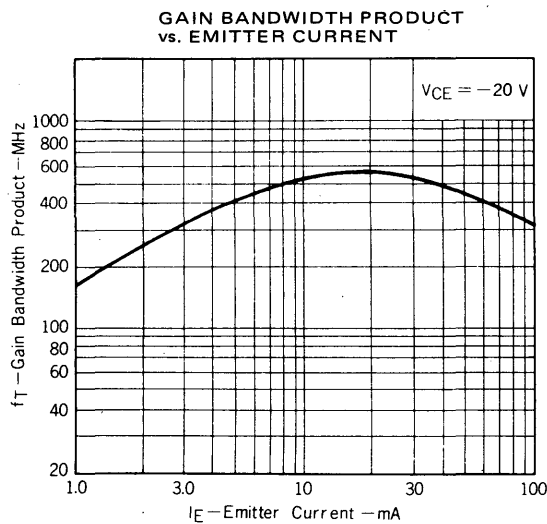
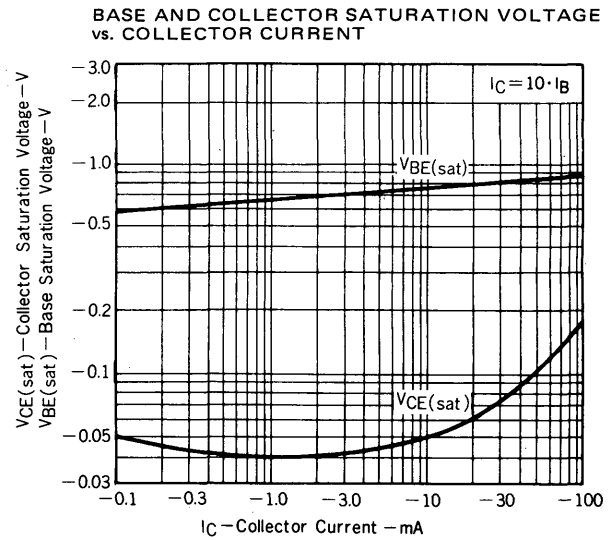
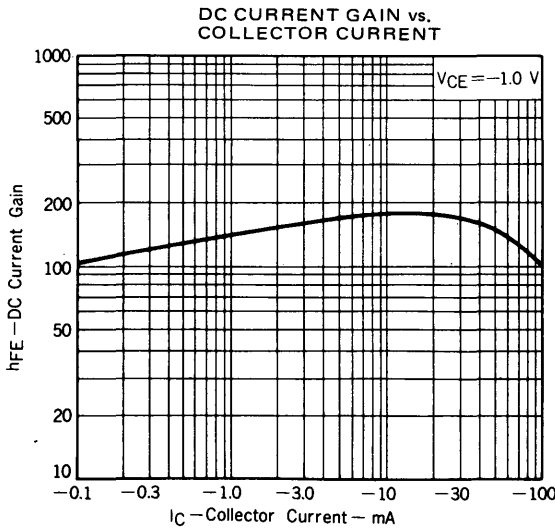
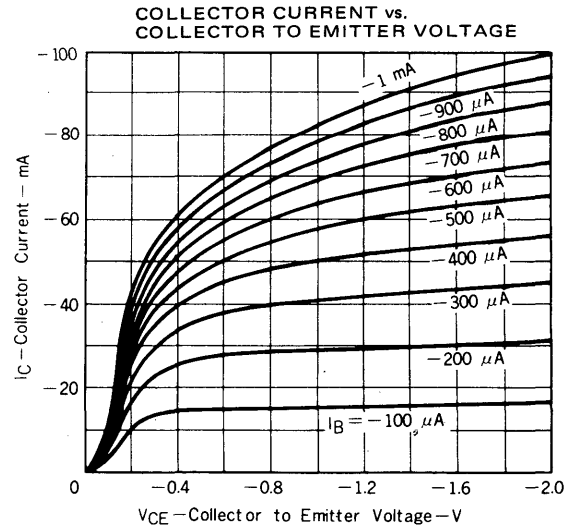
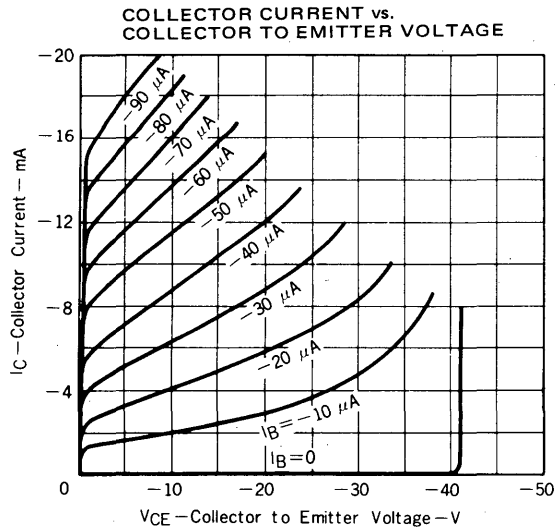

TURN-ON TIME vs. COLLECTOR CURRENT

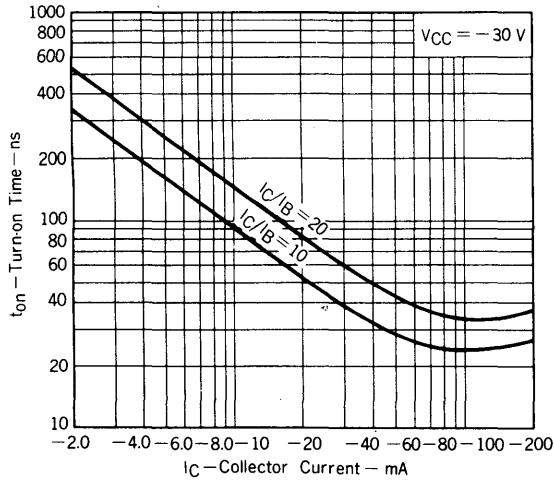

RISE TIME vs. COLLECTOR CURRENT

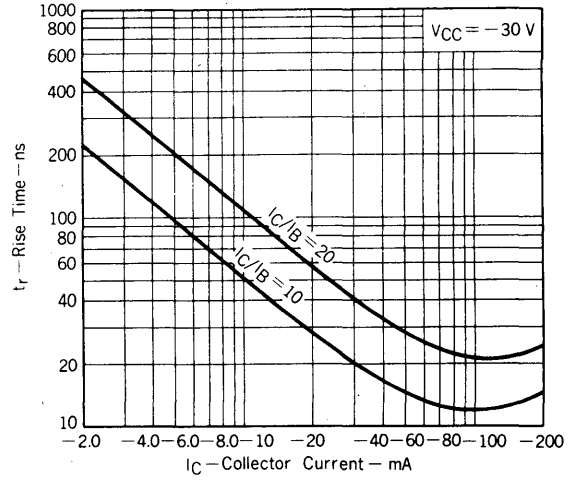

STORAGE TIME vs. COLLECTOR CURRENT

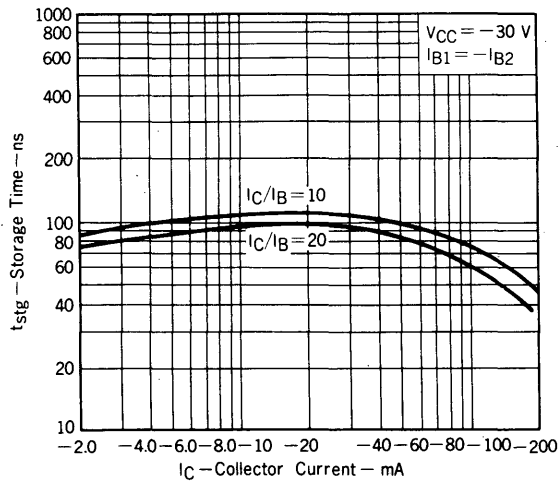

FALL TIME vs. COLLECTOR CURRENT

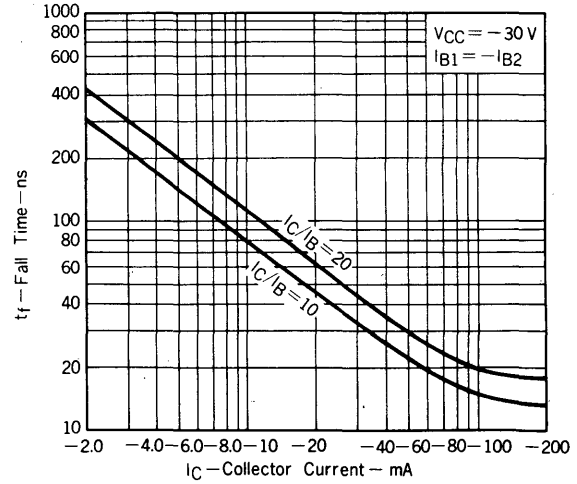

NEC Corporation

INTERNATIONAL ELECTRON DEVICES DIV.
 SUMITOMO MITA Building, 37-8,
 Shiba Gochome, Minato-ku, Tokyo 108, Japan
 Tel: Tokyo 456-3111
 Telex Address: NECTOK J22686
 Cable Address: NEC TOKYO

This datasheet has been download from:

www.datasheetcatalog.com

Datasheets for electronics components.