

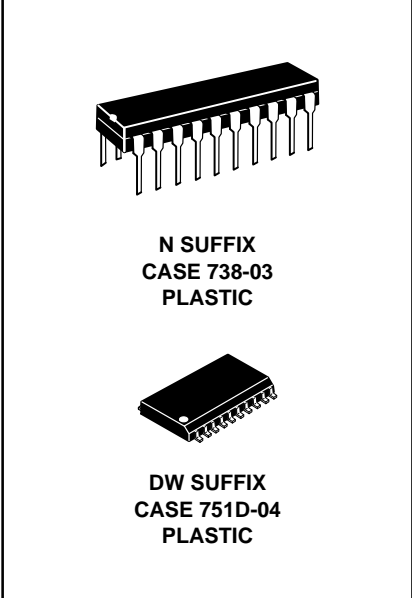

MC74AC377 MC74ACT377

OCTAL D
FLIP-FLOP WITH
CLOCK ENABLE



Octal D Flip-Flop with Clock Enable

The MC74AC377/74ACT377 has eight edge-triggered, D-type flip-flops with individual D inputs and Q outputs. The common buffered Clock (CP) input loads all flip-flops simultaneously, when the Clock Enable (CE) is LOW.

The register is fully edge-triggered. The state of each D input, one setup time before the LOW-to-HIGH clock transition, is transferred to the corresponding flip-flop's Q output. The CE input must be stable only one setup time prior to the LOW-to-HIGH clock transition for predictable operation.

- Ideal for Addressable Register Applications
- Clock Enable for Address and Data Synchronization Applications
- Eight Edge-Triggered D Flip-Flops
- Buffered Common Clock
- Outputs Source/Sink 24 mA
- See MC74AC273 for Master Reset Version
- See MC74AC373 for Transparent Latch Version
- See MC74AC374 for 3-State Version
- 'ACT377 Has TTL Compatible Inputs

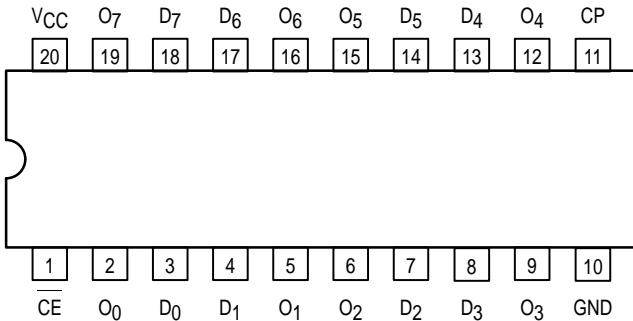

PIN NAMES

- D_0 - D_7 Data Inputs
- CE Clock Enable (Active LOW)
- Q_0 - Q_7 Data Outputs
- CP Clock Pulse Input

MODE SELECT-FUNCTION TABLE

| Operating Mode | Inputs | | | Outputs |
|-------------------|--------|----|-------|-----------|
| | CP | CE | D_n | Q_n |
| Load '1' | ┐ | L | H | H |
| Load '0' | ┐ | L | L | L |
| Hold (Do Nothing) | ┐ | H | X | No Change |
| | X | H | X | No Change |

H = HIGH Voltage Level
L = LOW Voltage Level
X = Immaterial
┐ = LOW-to-HIGH Clock Transition

LOGIC SYMBOL

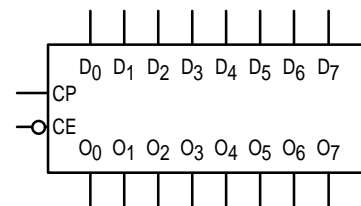

MC74AC377 MC74ACT377

LOGIC DIAGRAM

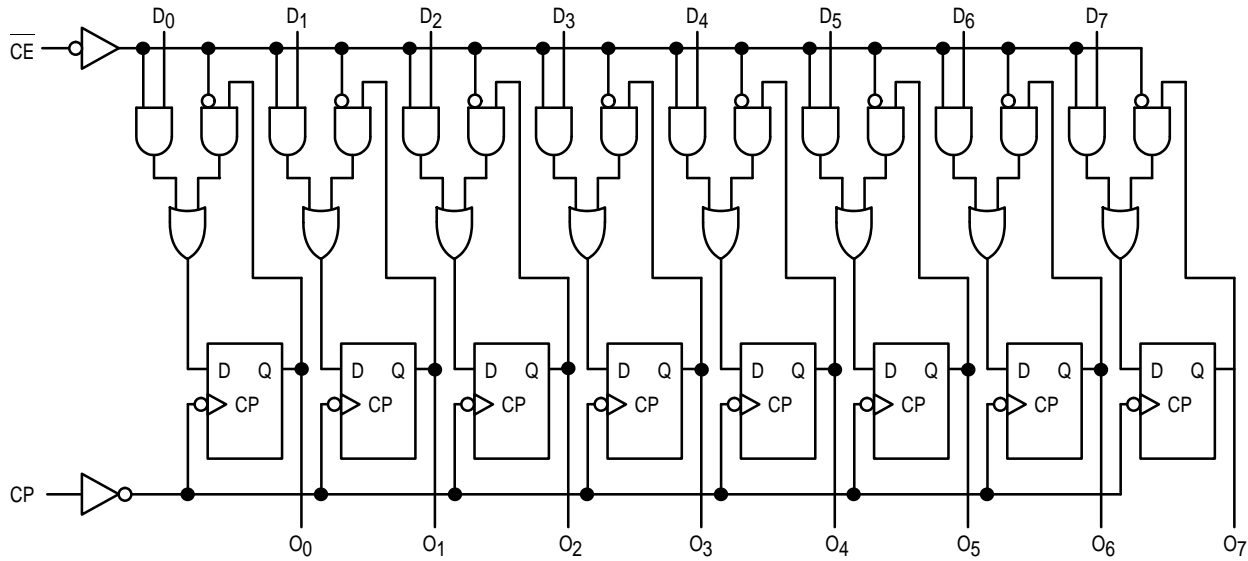

Please note that this diagram is provided only for the understanding of logic operations and should not be used to estimate propagation delays.

MAXIMUM RATINGS*

| Symbol | Parameter | Value | Unit |
|-----------|---|------------------------|--------------------|
| V_{CC} | DC Supply Voltage (Referenced to GND) | -0.5 to +7.0 | V |
| V_{in} | DC Input Voltage (Referenced to GND) | -0.5 to $V_{CC} + 0.5$ | V |
| V_{out} | DC Output Voltage (Referenced to GND) | -0.5 to $V_{CC} + 0.5$ | V |
| I_{in} | DC Input Current, per Pin | ± 20 | mA |
| I_{out} | DC Output Sink/Source Current, per Pin | ± 50 | mA |
| I_{CC} | DC V_{CC} or GND Current per Output Pin | ± 50 | mA |
| T_{stg} | Storage Temperature | -65 to +150 | $^{\circ}\text{C}$ |

* Maximum Ratings are those values beyond which damage to the device may occur. Functional operation should be restricted to the Recommended Operating Conditions.

RECOMMENDED OPERATING CONDITIONS

| Symbol | Parameter | Min | Typ | Max | Unit | |
|-------------------|---|-------------------------|-----|----------|--------------------|------|
| V_{CC} | Supply Voltage | 'AC | 2.0 | 5.0 | 6.0 | V |
| | | 'ACT | 4.5 | 5.0 | 5.5 | |
| V_{in}, V_{out} | DC Input Voltage, Output Voltage (Ref. to GND) | 0 | | V_{CC} | V | |
| t_r, t_f | Input Rise and Fall Time (Note 1) 'AC Devices except Schmitt Inputs | $V_{CC} @ 3.0\text{ V}$ | | 150 | | ns/V |
| | | $V_{CC} @ 4.5\text{ V}$ | | 40 | | |
| | | $V_{CC} @ 5.5\text{ V}$ | | 25 | | |
| t_r, t_f | Input Rise and Fall Time (Note 2) 'ACT Devices except Schmitt Inputs | $V_{CC} @ 4.5\text{ V}$ | | 10 | | ns/V |
| | | $V_{CC} @ 5.5\text{ V}$ | | 8.0 | | |
| T_J | Junction Temperature (PDIP) | | | 140 | $^{\circ}\text{C}$ | |
| T_A | Operating Ambient Temperature Range | -40 | 25 | 85 | $^{\circ}\text{C}$ | |
| I_{OH} | Output Current — High | | | -24 | mA | |
| I_{OL} | Output Current — Low | | | 24 | mA | |

1. V_{in} from 30% to 70% V_{CC} ; see individual Data Sheets for devices that differ from the typical input rise and fall times.

2. V_{in} from 0.8 V to 2.0 V; see individual Data Sheets for devices that differ from the typical input rise and fall times.

MC74AC377 MC74ACT377

DC CHARACTERISTICS

| Symbol | Parameter | V _{CC} (V) | 74AC | | 74AC | | Unit | Conditions |
|------------------|-----------------------------------|------------------------|------------------------|-------------------|------------------------------------|--|------|---|
| | | | T _A = +25°C | | T _A = -40°C to +85°C | | | |
| | | | Typ | Guaranteed Limits | | | | |
| V _{IH} | Minimum High Level Input Voltage | 3.0 | 1.5 | 2.1 | 2.1 | | V | V _{OUT} = 0.1 V or V _{CC} - 0.1 V |
| | | 4.5 | 2.25 | 3.15 | 3.15 | | | |
| | | 5.5 | 2.75 | 3.85 | 3.85 | | | |
| V _{IL} | Maximum Low Level Input Voltage | 3.0 | 1.5 | 0.9 | 0.9 | | V | V _{OUT} = 0.1 V or V _{CC} - 0.1 V |
| | | 4.5 | 2.25 | 1.35 | 1.35 | | | |
| | | 5.5 | 2.75 | 1.65 | 1.65 | | | |
| V _{OH} | Minimum High Level Output Voltage | 3.0 | 2.99 | 2.9 | 2.9 | | V | I _{OUT} = -50 μA |
| | | 4.5 | 4.49 | 4.4 | 4.4 | | | |
| | | 5.5 | 5.49 | 5.4 | 5.4 | | | |
| | | 3.0 | | 2.56 | 2.46 | | V | *V _{IN} = V _{IL} or V _{IH} -12 mA I _{OH} -24 mA -24 mA |
| | | 4.5 | | 3.86 | 3.76 | | | |
| | | 5.5 | | 4.86 | 4.76 | | | |
| V _{OL} | Maximum Low Level Output Voltage | 3.0 | 0.002 | 0.1 | 0.1 | | V | I _{OUT} = 50 μA |
| | | 4.5 | 0.001 | 0.1 | 0.1 | | | |
| | | 5.5 | 0.001 | 0.1 | 0.1 | | | |
| | | 3.0 | | 0.36 | 0.44 | | V | *V _{IN} = V _{IL} or V _{IH} 12 mA I _{OL} 24 mA 24 mA |
| | | 4.5 | | 0.36 | 0.44 | | | |
| | | 5.5 | | 0.36 | 0.44 | | | |
| I _{IN} | Maximum Input Leakage Current | 5.5 | | ±0.1 | ±1.0 | | μA | V _I = V _{CC} , GND |
| I _{OLD} | †Minimum Dynamic Output Current | 5.5 | | | 75 | | mA | V _{OLD} = 1.65 V Max |
| I _{OHD} | | 5.5 | | | -75 | | mA | V _{OHD} = 3.85 V Min |
| I _{CC} | Maximum Quiescent Supply Current | 5.5 | | 8.0 | 80 | | μA | V _{IN} = V _{CC} or GND |

* All outputs loaded; thresholds on input associated with output under test.

† Maximum test duration 2.0 ms, one output loaded at a time.

Note: I_{IN} and I_{CC} @ 3.0 V are guaranteed to be less than or equal to the respective limit @ 5.5 V V_{CC}.

AC CHARACTERISTICS (For Figures and Waveforms — See Section 3)

| Symbol | Parameter | V _{CC} * (V) | 74AC | | | 74AC | | Unit | Fig. No. |
|------------------|---|--------------------------|--|-----|-----|--|------|------|----------|
| | | | T _A = +25°C C _L = 50 pF | | | T _A = -40°C to +85°C C _L = 50 pF | | | |
| | | | Min | Typ | Max | Min | Max | | |
| f _{max} | Maximum Clock Frequency | 3.3 | 90 | | | 75 | MHz | 3-3 | |
| | | 5.0 | 140 | | | 125 | | | |
| t _{PLH} | Propagation Delay CP to Q _n | 3.3 | 3.0 | | 13 | 1.5 | 14 | ns | 3-6 |
| | | 5.0 | 2.0 | | 9.0 | 1.5 | 10 | | |
| t _{PHL} | Propagation Delay CP to Q _n | 3.3 | 3.5 | | 13 | 2.0 | 14.5 | ns | 3-6 |
| | | 5.0 | 2.5 | | 10 | 1.5 | 11 | | |

* Voltage Range 3.3 V is 3.3 V ±0.3 V.

Voltage Range 5.0 V is 5.0 V ±0.5 V.

MC74AC377 MC74ACT377

AC OPERATING REQUIREMENTS

| Symbol | Parameter | V _{CC} * (V) | 74AC | | Unit | Fig. No. | |
|----------------|---|--------------------------|--|--------------------|------|----------|--|
| | | | T _A = +25°C C _L = 50 pF | | | | T _A = -40°C to +85°C C _L = 50 pF |
| | | | Typ | Guaranteed Minimum | | | |
| t _s | Setup Time, HIGH or LOW D _n to CP | 3.3 | 5.5 | 6.0 | ns | 3-9 | |
| | | 5.0 | 4.0 | 4.5 | | | |
| t _h | Hold Time, HIGH or LOW D _n to CP | 3.3 | 0 | 0 | ns | 3-9 | |
| | | 5.0 | 1.0 | 1.0 | | | |
| t _s | Setup Time, HIGH or LOW CE to CP | 3.3 | 6.0 | 7.5 | ns | 3-9 | |
| | | 5.0 | 4.0 | 4.5 | | | |
| t _h | Hold Time, HIGH or LOW CE to CP | 3.3 | 0 | 0 | ns | 3-9 | |
| | | 5.0 | 1.0 | 1.0 | | | |
| t _w | CP Pulse Width HIGH or LOW | 3.3 | 5.5 | 6.0 | ns | 3-6 | |
| | | 5.0 | 4.0 | 4.5 | | | |

* Voltage Range 3.3 V is 3.3 V ±0.3 V.
Voltage Range 5.0 V is 5.0 V ±0.5 V.

DC CHARACTERISTICS

| Symbol | Parameter | V _{CC} (V) | 74ACT | | 74ACT | | Unit | Conditions |
|-------------------|--|------------------------|------------------------|-------------------|------------------------------------|----|---|------------|
| | | | T _A = +25°C | | T _A = -40°C to +85°C | | | |
| | | | Typ | Guaranteed Limits | | | | |
| V _{IH} | Minimum High Level Input Voltage | 4.5 | 1.5 | 2.0 | 2.0 | V | V _{OUT} = 0.1 V or V _{CC} - 0.1 V | |
| | | 5.5 | 1.5 | 2.0 | 2.0 | | | |
| V _{IL} | Maximum Low Level Input Voltage | 4.5 | 1.5 | 0.8 | 0.8 | V | V _{OUT} = 0.1 V or V _{CC} - 0.1 V | |
| | | 5.5 | 1.5 | 0.8 | 0.8 | | | |
| V _{OH} | Minimum High Level Output Voltage | 4.5 | 4.49 | 4.4 | 4.4 | V | I _{OUT} = -50 μA | |
| | | 5.5 | 5.49 | 5.4 | 5.4 | | | |
| | | 4.5 | | 3.86 | 3.76 | V | *V _{IN} = V _{IL} or V _{IH} -24 mA I _{OH} -24 mA | |
| | | 5.5 | | 4.86 | 4.76 | | | |
| V _{OL} | Maximum Low Level Output Voltage | 4.5 | 0.001 | 0.1 | 0.1 | V | I _{OUT} = 50 μA | |
| | | 5.5 | 0.001 | 0.1 | 0.1 | | | |
| | | 4.5 | | 0.36 | 0.44 | V | *V _{IN} = V _{IL} or V _{IH} 24 mA I _{OL} 24 mA | |
| | | 5.5 | | 0.36 | 0.44 | | | |
| I _{IN} | Maximum Input Leakage Current | 5.5 | | ±0.1 | ±1.0 | μA | V _I = V _{CC} , GND | |
| ΔI _{CCT} | Additional Max. I _{CC} /Input | 5.5 | 0.6 | | 1.5 | mA | V _I = V _{CC} - 2.1 V | |
| I _{OLD} | †Minimum Dynamic Output Current | 5.5 | | | 75 | mA | V _{OLD} = 1.65 V Max | |
| I _{OHD} | | 5.5 | | | -75 | mA | V _{OHD} = 3.85 V Min | |
| I _{CC} | Maximum Quiescent Supply Current | 5.5 | | 8.0 | 80 | μA | V _{IN} = V _{CC} or GND | |

* All outputs loaded; thresholds on input associated with output under test.

† Maximum test duration 2.0 ms, one output loaded at a time.

MC74AC377 MC74ACT377

AC CHARACTERISTICS (For Figures and Waveforms — See Section 3)

| Symbol | Parameter | V _{CC} * (V) | 74ACT | | | 74ACT | | Unit | Fig. No. |
|------------------|---|-----------------------|--|-----|-----|--|-----|------|----------|
| | | | T _A = +25°C C _L = 50 pF | | | T _A = -40°C to +85°C C _L = 50 pF | | | |
| | | | Min | Typ | Max | Min | Max | | |
| f _{max} | Maximum Clock Frequency | 5.0 | 140 | | | 125 | | MHz | 3-3 |
| t _{PLH} | Propagation Delay CP to Q _n | 5.0 | 3.0 | | 9.0 | 2.5 | 10 | ns | 3-6 |
| t _{PHL} | Propagation Delay CP to Q _n | 5.0 | 3.5 | | 10 | 2.5 | 11 | ns | 3-6 |

* Voltage Range 5.0 V is 5.0 V ±0.5 V.

AC OPERATING REQUIREMENTS

| Symbol | Parameter | V _{CC} * (V) | 74ACT | | 74ACT | | Unit | Fig. No. |
|----------------|---|-----------------------|--|--------------------|--|--|------|----------|
| | | | T _A = +25°C C _L = 50 pF | | T _A = -40°C to +85°C C _L = 50 pF | | | |
| | | | Typ | Guaranteed Minimum | | | | |
| t _s | Setup Time, HIGH or LOW D _n to CP | 5.0 | | 4.5 | 5.5 | | ns | 3-9 |
| t _h | Hold Time, HIGH or LOW D _n to CP | 5.0 | | 1.0 | 1.0 | | ns | 3-9 |
| t _s | Setup Time, HIGH or LOW CE to CP | 5.0 | | 4.5 | 5.5 | | ns | 3-9 |
| t _h | Hold Time, HIGH or LOW CE to CP | 5.0 | | 1.0 | 1.0 | | ns | 3-9 |
| t _w | CP Pulse Width HIGH or LOW | 5.0 | | 4.0 | 4.5 | | ns | 3-6 |

* Voltage Range 5.0 V is 5.0 V ±0.5 V.

CAPACITANCE

| Symbol | Parameter | Value Typ | Unit | Test Conditions |
|-----------------|-------------------------------|--------------|------|-------------------------|
| C _{IN} | Input Capacitance | 4.5 | pF | V _{CC} = 5.0 V |
| CPD | Power Dissipation Capacitance | 90 | pF | V _{CC} = 5.0 V |

MC74AC377 MC74ACT377

OUTLINE DIMENSIONS

N SUFFIX PLASTIC DIP PACKAGE CASE 738-03 ISSUE E

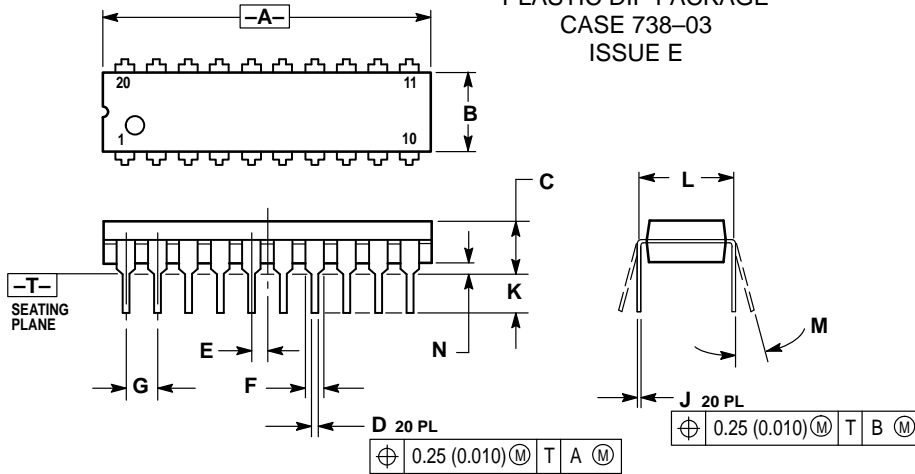

- NOTES:
1. DIMENSIONING AND TOLERANCING PER ANSI Y14.5M, 1982.
 2. CONTROLLING DIMENSION: INCH.
 3. DIMENSION L TO CENTER OF LEAD WHEN FORMED PARALLEL.
 4. DIMENSION B DOES NOT INCLUDE MOLD FLASH.

| DIM | INCHES | | MILLIMETERS | |
|-----|-----------|-------|-------------|-------|
| | MIN | MAX | MIN | MAX |
| A | 1.010 | 1.070 | 25.66 | 27.17 |
| B | 0.240 | 0.260 | 6.10 | 6.60 |
| C | 0.150 | 0.180 | 3.81 | 4.57 |
| D | 0.015 | 0.022 | 0.39 | 0.55 |
| E | 0.050 BSC | | 1.27 BSC | |
| F | 0.050 | 0.070 | 1.27 | 1.77 |
| G | 0.100 BSC | | 2.54 BSC | |
| J | 0.008 | 0.015 | 0.21 | 0.38 |
| K | 0.110 | 0.140 | 2.80 | 3.55 |
| L | 0.300 BSC | | 7.62 BSC | |
| M | 0° | 15° | 0° | 15° |
| N | 0.020 | 0.040 | 0.51 | 1.01 |

DW SUFFIX PLASTIC SOIC PACKAGE CASE 751D-04 ISSUE E

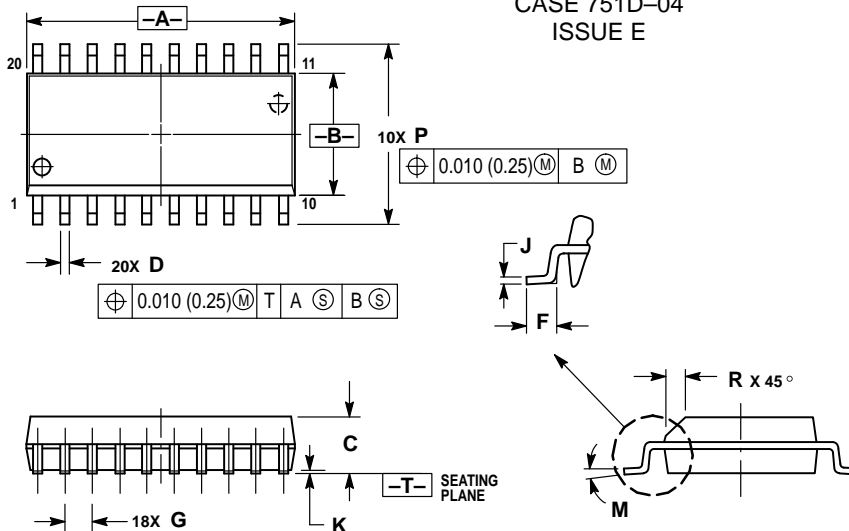

- NOTES:
1. DIMENSIONING AND TOLERANCING PER ANSI Y14.5M, 1982.
 2. CONTROLLING DIMENSION: MILLIMETER.
 3. DIMENSIONS A AND B DO NOT INCLUDE MOLD PROTRUSION.
 4. MAXIMUM MOLD PROTRUSION 0.150 (0.006) PER SIDE.
 5. DIMENSION D DOES NOT INCLUDE DAMBAR PROTRUSION. ALLOWABLE DAMBAR PROTRUSION SHALL BE 0.13 (0.005) TOTAL IN EXCESS OF D DIMENSION AT MAXIMUM MATERIAL CONDITION.

| DIM | MILLIMETERS | | INCHES | |
|-----|-------------|-------|-----------|-------|
| | MIN | MAX | MIN | MAX |
| A | 12.65 | 12.95 | 0.499 | 0.510 |
| B | 7.40 | 7.60 | 0.292 | 0.299 |
| C | 2.35 | 2.65 | 0.093 | 0.104 |
| D | 0.35 | 0.49 | 0.014 | 0.019 |
| F | 0.50 | 0.90 | 0.020 | 0.035 |
| G | 1.27 BSC | | 0.050 BSC | |
| J | 0.25 | 0.32 | 0.010 | 0.012 |
| K | 0.10 | 0.25 | 0.004 | 0.009 |
| M | 0° | 7° | 0° | 7° |
| P | 10.05 | 10.55 | 0.395 | 0.415 |
| R | 0.25 | 0.75 | 0.010 | 0.029 |

Motorola reserves the right to make changes without further notice to any products herein. Motorola makes no warranty, representation or guarantee regarding the suitability of its products for any particular purpose, nor does Motorola assume any liability arising out of the application or use of any product or circuit, and specifically disclaims any and all liability, including without limitation consequential or incidental damages. "Typical" parameters can and do vary in different applications. All operating parameters, including "Typicals" must be validated for each customer application by customer's technical experts. Motorola does not convey any license under its patent rights nor the rights of others. Motorola products are not designed, intended, or authorized for use as components in systems intended for surgical implant into the body, or other applications intended to support or sustain life, or for any other application in which the failure of the Motorola product could create a situation where personal injury or death may occur. Should Buyer purchase or use Motorola products for any such unintended or unauthorized application, Buyer shall indemnify and hold Motorola and its officers, employees, subsidiaries, affiliates, and distributors harmless against all claims, costs, damages, and expenses, and reasonable attorney fees arising out of, directly or indirectly, any claim of personal injury or death associated with such unintended or unauthorized use, even if such claim alleges that Motorola was negligent regarding the design or manufacture of the part. Motorola and  are registered trademarks of Motorola, Inc. Motorola, Inc. is an Equal Opportunity/Affirmative Action Employer.

How to reach us:

USA/EUROPE: Motorola Literature Distribution;
P.O. Box 20912; Phoenix, Arizona 85036. 1-800-441-2447

JAPAN: Nippon Motorola Ltd.; Tatsumi-SPD-JLDC, Toshikatsu Otsuka,
6F Seibu-Butsuryu-Center, 3-14-2 Tatsumi Koto-Ku, Tokyo 135, Japan. 03-3521-8315

MFAX: RMFAX0@email.sps.mot.com -TOUCHTONE (602) 244-6609
INTERNET: <http://Design-NET.com>

HONG KONG: Motorola Semiconductors H.K. Ltd.; 8B Tai Ping Industrial Park,
51 Ting Kok Road, Tai Po, N.T., Hong Kong. 852-26629298



MC74AC377/D

