

# NTF2955

## Power MOSFET

-60 V, -2.6 A, Single P-Channel SOT-223

### Features

- TMOS7 Design for low  $R_{DS(on)}$
- Withstands High Energy in Avalanche and Commutation Modes

### Applications

- Power Supplies
- PWM Motor Control
- Converters
- Power Management

### MAXIMUM RATINGS ( $T_J = 25^\circ\text{C}$ unless otherwise noted)

Parameter		Symbol	Value	Unit	
Drain-to-Source Voltage		$V_{DSS}$	-60	V	
Gate-to-Source Voltage		$V_{GS}$	$\pm 20$	V	
Continuous Drain Current (Note 1)	Steady State	$T_A = 25^\circ\text{C}$	$I_D$	-2.6	A
				$T_A = 85^\circ\text{C}$	
Power Dissipation (Note 1)	Steady State	$T_A = 25^\circ\text{C}$	$P_D$	2.3	W
Continuous Drain Current (Note 2)	Steady State	$T_A = 25^\circ\text{C}$	$I_D$	-1.7	A
				$T_A = 85^\circ\text{C}$	
Power Dissipation (Note 2)		$T_A = 25^\circ\text{C}$	$P_D$	1.0	W
Pulsed Drain Current	$tp = 10 \mu\text{s}$	$I_{DM}$	-10.4	A	
Operating Junction and Storage Temperature		$T_J, T_{STG}$	-55 to 175	$^\circ\text{C}$	
Single Pulse Drain-to-Source Avalanche Energy ( $V_{DD} = 25 \text{ V}, V_G = 10 \text{ V}, I_{PK} = 6.7 \text{ A}, L = 10 \text{ mH}, R_G = 25 \Omega$ )		EAS	225	mJ	
Lead Temperature for Soldering Purposes (1/8" from case for 10 s)		$T_L$	260	$^\circ\text{C}$	

### THERMAL RESISTANCE RATINGS

Parameter	Symbol	Max	Unit
Junction-to-Tab (Drain) - Steady State (Note 2)	$R_{\theta JC}$	14	$^\circ\text{C}/\text{W}$
Junction-to-Ambient - Steady State (Note 1)	$R_{\theta JA}$	65	
Junction-to-Ambient - Steady State (Note 2)	$R_{\theta JA}$	150	

Maximum ratings are those values beyond which device damage can occur. Maximum ratings applied to the device are individual stress limit values (not normal operating conditions) and are not valid simultaneously. If these limits are exceeded, device functional operation is not implied, damage may occur and reliability may be affected.

1. When surface mounted to an FR4 board using 1 in. pad size (Cu. area = 1.127 in<sup>2</sup> [1 oz] including traces)
2. When surface mounted to an FR4 board using the minimum recommended pad size (Cu. area = 0.341 in<sup>2</sup>)



ON Semiconductor®

<http://onsemi.com>

$V_{(BR)DSS}$	$R_{DS(on)}$ TYP	$I_D$ MAX
-60 V	145 m $\Omega$ @ -10 V	-2.6 A

### P-Channel

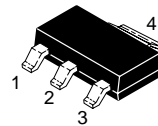
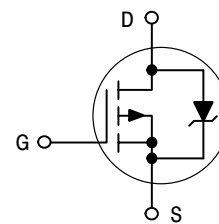

SOT-223  
CASE 318E  
STYLE 3

### MARKING DIAGRAM

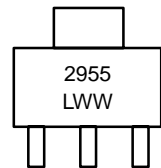

2955 = Device Code  
L = Location Code  
WW = Work Week

### PIN ASSIGNMENT

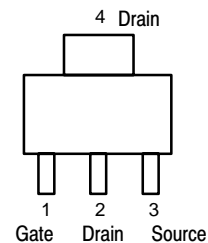

### ORDERING INFORMATION

Device	Package	Shipping†
NTF2955T1	SOT-223	1000/Tape & Reel
NTF2955T3	SOT-223	4000/Tape & Reel

†For information on tape and reel specifications, including part orientation and tape sizes, please refer to our Tape and Reel Packaging Specification Brochure, BRD8011/D.

# NTF2955

## ELECTRICAL CHARACTERISTICS (T<sub>J</sub>=25°C unless otherwise stated)

Parameter	Symbol	Test Condition	Min	Typ	Max	Unit
-----------	--------	----------------	-----	-----	-----	------

### OFF CHARACTERISTICS

Drain-to-Source Breakdown Voltage	V <sub>(BR)DSS</sub>	V <sub>GS</sub> = 0 V, I <sub>D</sub> = -250 μA	-60			V
Drain-to-Source Breakdown Voltage Temperature Coefficient	V <sub>(BR)DSS</sub> /T <sub>J</sub>			66.4		mV/°C
Zero Gate Voltage Drain Current	I <sub>DSS</sub>	V <sub>GS</sub> = 0 V, V <sub>DS</sub> = -60 V	T <sub>J</sub> = 25°C		-1.0	μA
			T <sub>J</sub> = 125°C		-50	
Gate-to-Source Leakage Current	I <sub>GSS</sub>	V <sub>DS</sub> = 0 V, V <sub>GS</sub> = ±20 V			±100	nA

### ON CHARACTERISTICS (Note 3)

Gate Threshold Voltage	V <sub>GS(TH)</sub>	V <sub>GS</sub> = V <sub>DS</sub> , I <sub>D</sub> = -1.0 mA	-2.0		-4.0	V
Drain-to-Source On Resistance	R <sub>DS(on)</sub>	V <sub>GS</sub> = -10 V, I <sub>D</sub> = -0.75 A		145	170	mΩ
		V <sub>GS</sub> = -10 V, I <sub>D</sub> = -1.5 A		150	180	
		V <sub>GS</sub> = -10 V, I <sub>D</sub> = -2.4 A		154	185	
Forward Transconductance	g <sub>FS</sub>	V <sub>GS</sub> = -15 V, I <sub>D</sub> = -0.75 A		1.77		S

### CHARGES AND CAPACITANCES

Input Capacitance	C <sub>ISS</sub>	V <sub>GS</sub> = 0 V, f = 1.0 MHz, V <sub>DS</sub> = 25 V		492		pF
Output Capacitance	C <sub>OSS</sub>			165		
Reverse Transfer Capacitance	C <sub>RSS</sub>			50		
Total Gate Charge	Q <sub>G(TOT)</sub>	V <sub>GS</sub> = 10 V, V <sub>DS</sub> = 30 V, I <sub>D</sub> = 1.5 A		14.3		nC
Threshold Gate Charge	Q <sub>G(TH)</sub>			1.2		
Gate-to-Source Charge	Q <sub>GS</sub>			2.3		
Gate-to-Drain Charge	Q <sub>GD</sub>			5.2		

### SWITCHING CHARACTERISTICS (Note 4)

Turn-On Delay Time	t <sub>d(ON)</sub>	V <sub>GS</sub> = 10 V, V <sub>DD</sub> = 25 V, I <sub>D</sub> = 1.5 A, R <sub>G</sub> = 9.1 Ω R <sub>L</sub> = 25 Ω		11		ns
Rise Time	t <sub>r</sub>			7.6		
Turn-Off Delay Time	t <sub>d(OFF)</sub>			65		
Fall Time	t <sub>f</sub>			38		

### DRAIN-SOURCE DIODE CHARACTERISTICS

Forward Diode Voltage	V <sub>SD</sub>	V <sub>GS</sub> = 0 V, I <sub>S</sub> = 1.5 A	T <sub>J</sub> = 25°C		-1.10	-1.30	V
			T <sub>J</sub> = 125°C		-0.9		
Reverse Recovery Time	t <sub>RR</sub>	V <sub>GS</sub> = 0 V, dI <sub>S</sub> /dt = 100 A/μs, I <sub>S</sub> = 1.5 A		36		ns	
Charge Time	t <sub>a</sub>			20			
Discharge Time	t <sub>b</sub>			16			
Reverse Recovery Charge	Q <sub>RR</sub>			0.139			nC

- Pulse Test: pulse width ≤ 300 μs, duty cycle ≤ 2%.
- Switching characteristics are independent of operating junction temperatures.

TYPICAL PERFORMANCE CURVES ( $T_J = 25^\circ\text{C}$  unless otherwise noted)

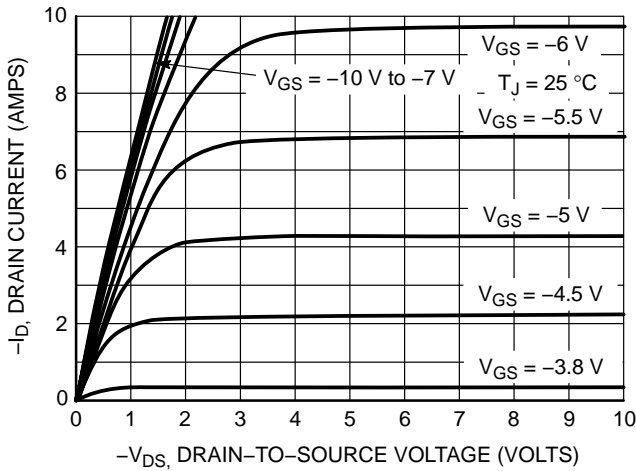

Figure 1. On-Region Characteristics

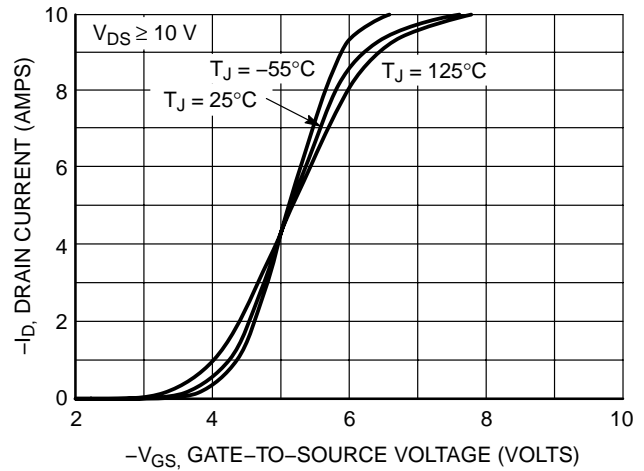

Figure 2. Transfer Characteristics

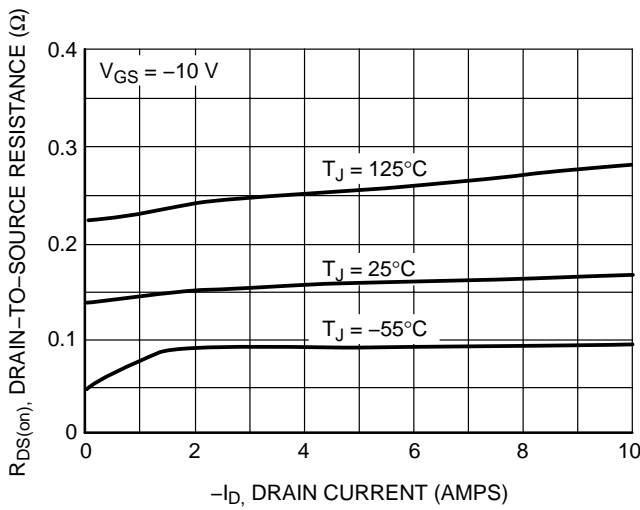

Figure 3. On-Resistance versus Drain Current and Temperature

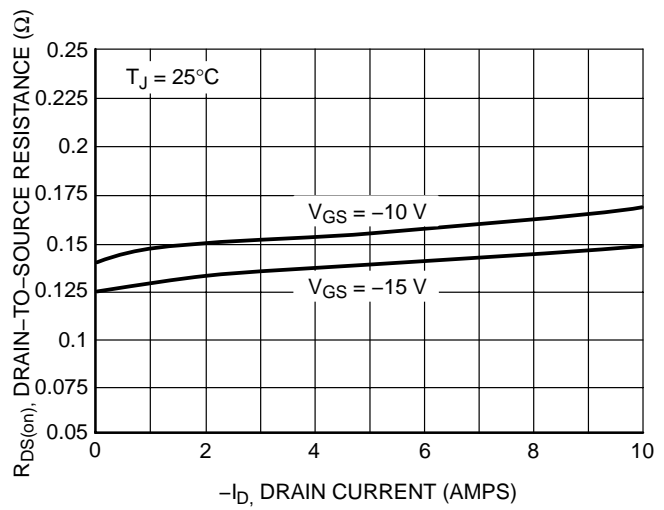

Figure 4. On-Resistance versus Drain Current and Gate Voltage

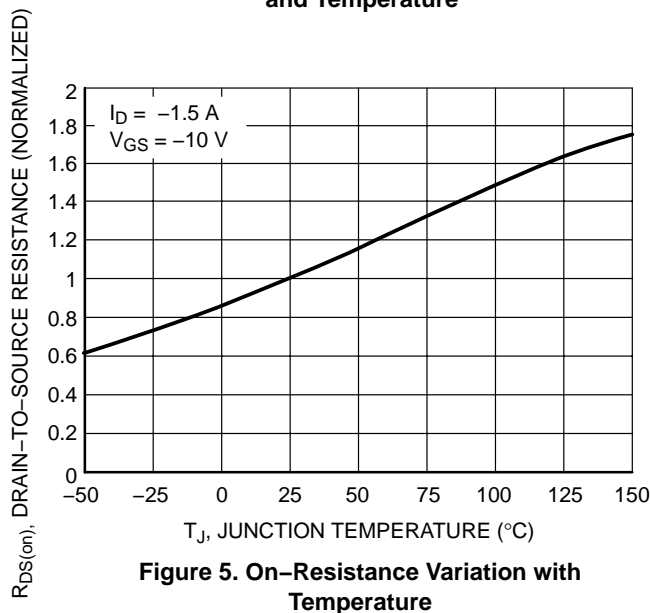

Figure 5. On-Resistance Variation with Temperature

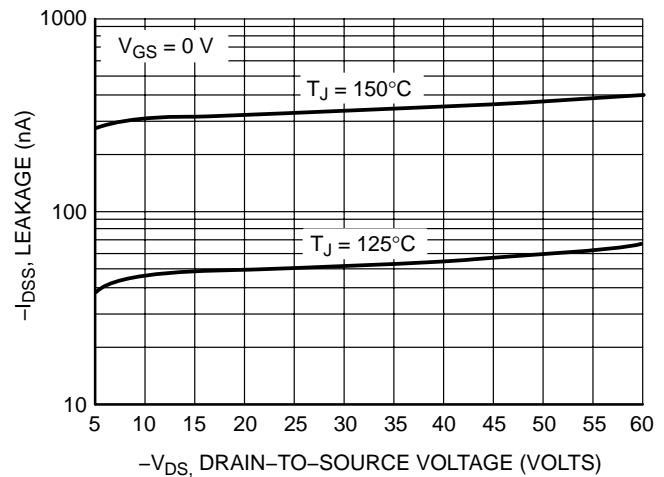

Figure 6. Drain-to-Source Leakage Current versus Voltage

TYPICAL PERFORMANCE CURVES ( $T_J = 25^\circ\text{C}$  unless otherwise noted)

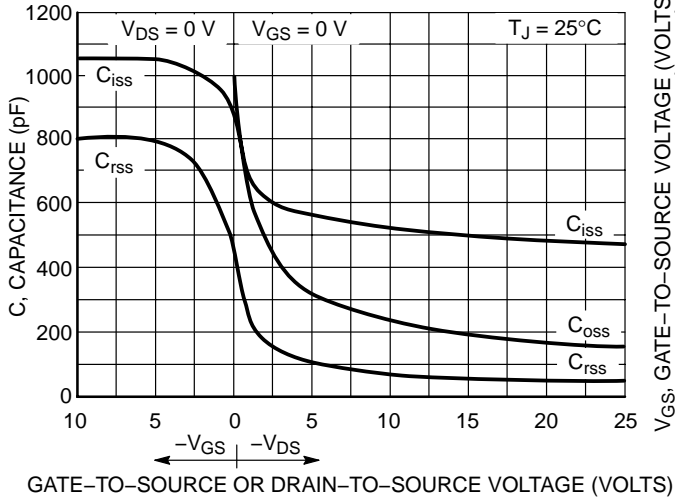

Figure 7. Capacitance Variation

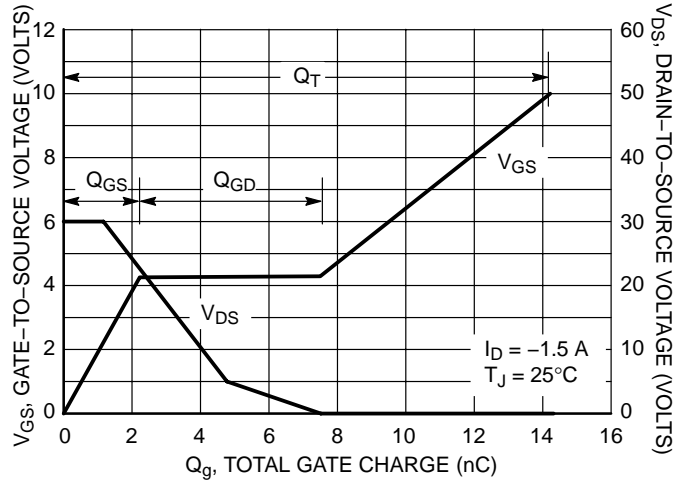

Figure 8. Gate-to-Source and Drain-to-Source Voltage versus Total Charge

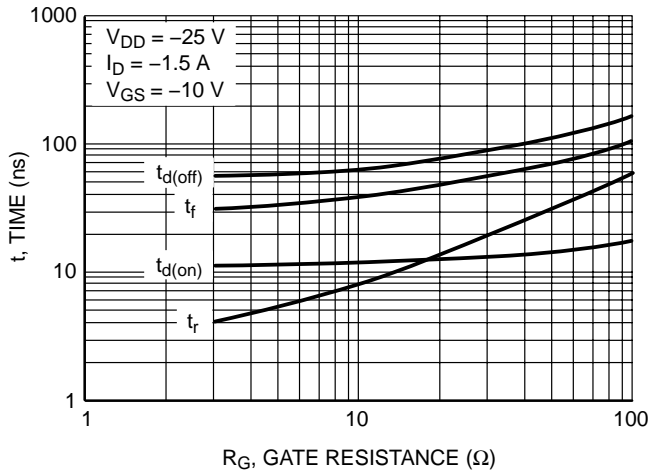

Figure 9. Resistive Switching Time Variation versus Gate Resistance

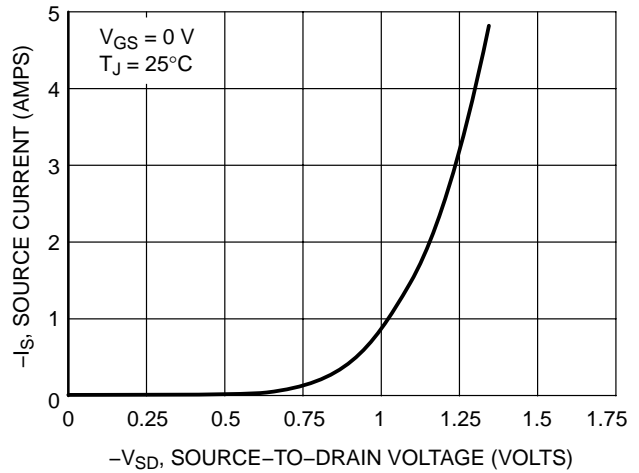

Figure 10. Diode Forward Voltage versus Current

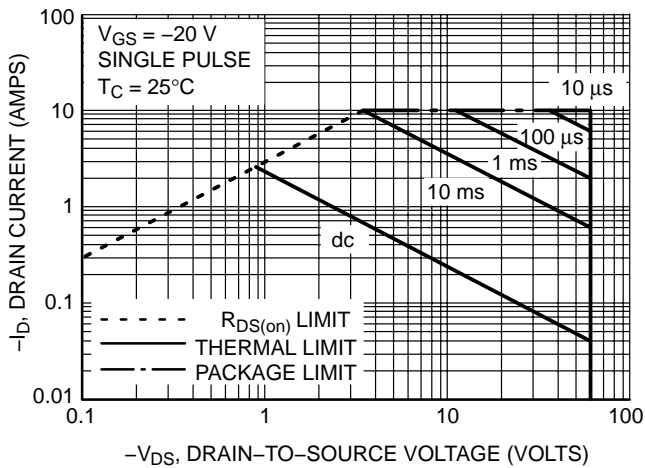

Figure 11. Maximum Rated Forward Biased Safe Operating Area

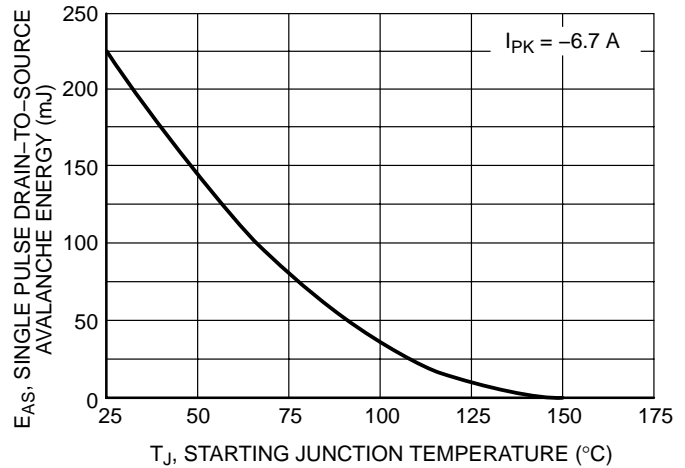
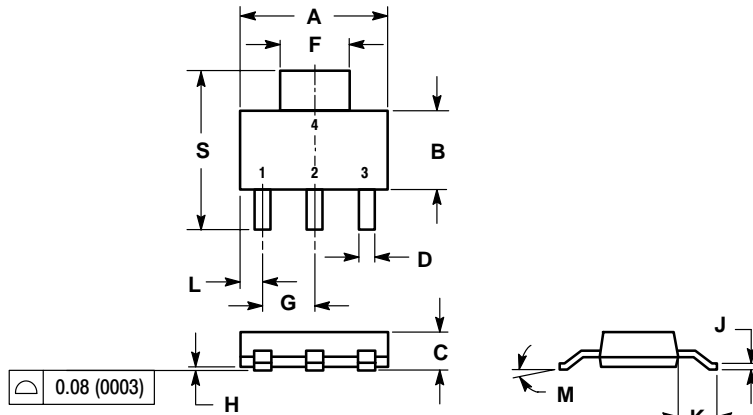

Figure 12. Maximum Avalanche Energy versus Starting Junction Temperature

# NTF2955

## PACKAGE DIMENSIONS

SOT-223 (TO-261)  
CASE 318E-04  
ISSUE K



- NOTES:  
1. DIMENSIONING AND TOLERANCING PER ANSI Y14.5M, 1982.  
2. CONTROLLING DIMENSION: INCH.

DIM	INCHES		MILLIMETERS	
	MIN	MAX	MIN	MAX
A	0.249	0.263	6.30	6.70
B	0.130	0.145	3.30	3.70
C	0.060	0.068	1.50	1.75
D	0.024	0.035	0.60	0.89
F	0.115	0.126	2.90	3.20
G	0.087	0.094	2.20	2.40
H	0.0008	0.0040	0.020	0.100
J	0.009	0.014	0.24	0.35
K	0.060	0.078	1.50	2.00
L	0.033	0.041	0.85	1.05
M	0°	10°	0°	10°
S	0.264	0.287	6.70	7.30

- STYLE 3:  
PIN 1. GATE  
2. DRAIN  
3. SOURCE  
4. DRAIN

### SOLDERING FOOTPRINT

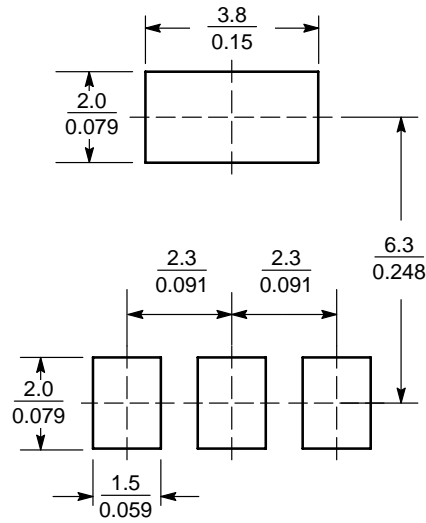

**ON Semiconductor** and  are registered trademarks of Semiconductor Components Industries, LLC (SCILLC). SCILLC reserves the right to make changes without further notice to any products herein. SCILLC makes no warranty, representation or guarantee regarding the suitability of its products for any particular purpose, nor does SCILLC assume any liability arising out of the application or use of any product or circuit, and specifically disclaims any and all liability, including without limitation special, consequential or incidental damages. "Typical" parameters which may be provided in SCILLC data sheets and/or specifications can and do vary in different applications and actual performance may vary over time. All operating parameters, including "Typicals" must be validated for each customer application by customer's technical experts. SCILLC does not convey any license under its patent rights nor the rights of others. SCILLC products are not designed, intended, or authorized for use as components in systems intended for surgical implant into the body, or other applications intended to support or sustain life, or for any other application in which the failure of the SCILLC product could create a situation where personal injury or death may occur. Should Buyer purchase or use SCILLC products for any such unintended or unauthorized application, Buyer shall indemnify and hold SCILLC and its officers, employees, subsidiaries, affiliates, and distributors harmless against all claims, costs, damages, and expenses, and reasonable attorney fees arising out of, directly or indirectly, any claim of personal injury or death associated with such unintended or unauthorized use, even if such claim alleges that SCILLC was negligent regarding the design or manufacture of the part. SCILLC is an Equal Opportunity/Affirmative Action Employer. This literature is subject to all applicable copyright laws and is not for resale in any manner.

## PUBLICATION ORDERING INFORMATION

### LITERATURE FULFILLMENT:

Literature Distribution Center for ON Semiconductor  
P.O. Box 61312, Phoenix, Arizona 85082-1312 USA  
**Phone:** 480-829-7710 or 800-344-3860 Toll Free USA/Canada  
**Fax:** 480-829-7709 or 800-344-3867 Toll Free USA/Canada  
**Email:** [orderlit@onsemi.com](mailto:orderlit@onsemi.com)

**N. American Technical Support:** 800-282-9855 Toll Free  
USA/Canada

**Japan:** ON Semiconductor, Japan Customer Focus Center  
2-9-1 Kamimeguro, Meguro-ku, Tokyo, Japan 153-0051  
**Phone:** 81-3-5773-3850

**ON Semiconductor Website:** <http://onsemi.com>

**Order Literature:** <http://www.onsemi.com/litorder>

For additional information, please contact your  
local Sales Representative.