

SUBMINIATURE PHOTOINTERRUPTER

MIR-3301

Description

The MIR-3301 consists of a Gallium Arsenide infrared emitting diode and a NPN silicon phototransistor built in a black plastic housing. It is a reflective subminiature photointerrupter.

Package Dimensions

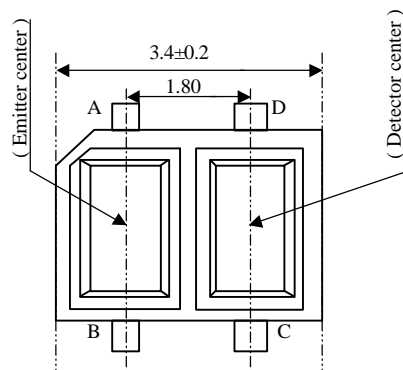

Unit: mm

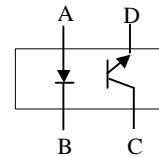

Features

- Compact and thin
- MIR-3301 : Compact DIP, long lead type
- Optimum detecting distance : 0.8 - 1.0 mm
- Wavelength : 940nm
- Visible light cut-off type

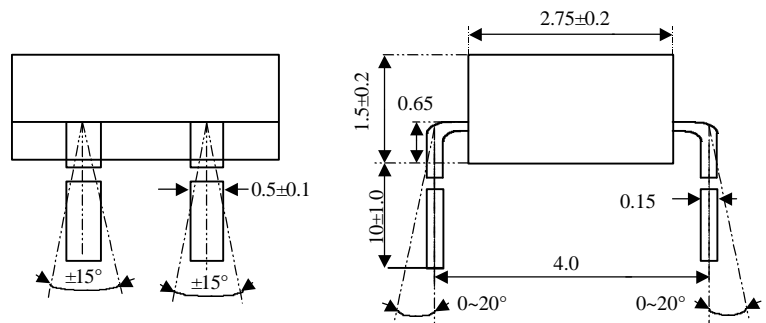

Absolute Maximum Ratings

@ T_A=25°C

Parameter		Symbol	Minimum Rating	Maximum Rating	Unit
INPUT	Continuous Forward Current	I _F		50	mA
	Reverse Voltage	V _R		5	V
	Power Dissipation	P _{ad}		75	mW
OUTPUT	Collector-emitter breakdown voltage	V _{(BR)CEO}	30		V
	Emitter-Collector breakdown voltage	V _{(BR)ECO}	5		V
	Collector power dissipation	P _C		75	mW
Total power dissipation		P _{TOT}		100	mW
Operating Temperature Range		T _{opr}	-25°C to + 85°C		
Storage Temperature Range		T _{stg}	-40°C to + 100°C		
Lead Soldering Temperature (within 5 sec, minimum 1.6mm from body) at 260°C					

UNI

Unity Opto Technology Co., Ltd.

02/04/2002

Optical-Electrical Characteristics

Parameter		Symbol	Min .	Typ .	Max .	Unit .	Test Conditions	
Input	Forward Voltage	V_F	-	1.2	1.4	V	$I_F=20mA$	
	Reverse Current	I_R	-	-	10	μA	$V_R=5V$	
Output	Collector Dark Current	I_{ceo}	-	-	100	nA	$V_{ce}=10V$	
Transfer Characteristics	*1 Collector Current	I_c	B	38	-	75	μA	$I_F=4mA, V_{ce}=5V$
			C	56	-	108		
			D	80	-	151		
			E	112	-	216		
	Response Time (RISE)	t_r	-	20	100	μS	$I_c=100\mu A, V_{ce}=2V$	
Response Time (FALL)	t_f	-	20	100	μS	$R_L=1K, d=1mm$		
	*2 Leak Current	I_{LEAK}	-	-	0.1	μA	$I_F=4mA, V_{ce}=5V$	

*1 THE CONDITION AND ARRANGEMENT OF THE REFLECTIVE OBJECT ARE SHOWN AS FOLLOWING .

*2 WITHOUT REFLECTIVE OBJECT.

TEST CONDITION AND ARRANGEMENT FOR COLLECTOR CURRENT

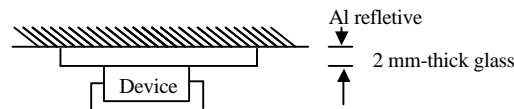

Typical Optical-Electrical Characteristic Curves

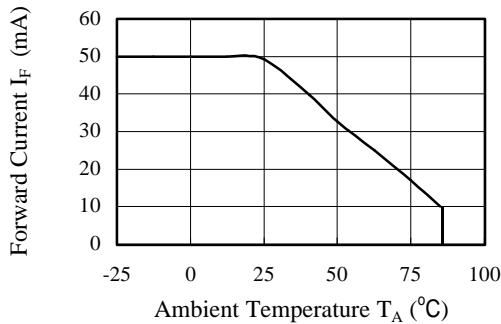

Fig.1 forward Current vs. Ambient Temperature

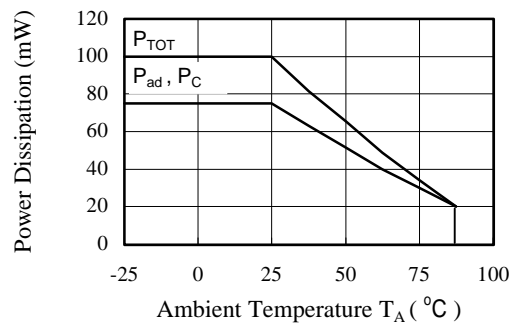

Fig.2 Power Dissipation vs. Ambient Temperature

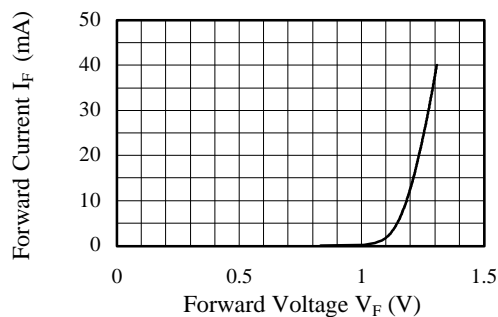

Fig.3 Forward Current vs Forward Voltage

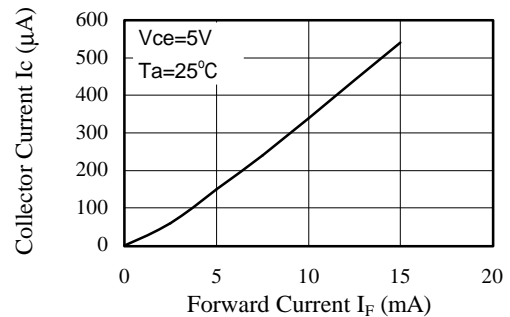

Fig.4 Collector Current vs. Forward Current

Typical Optical-Electrical Characteristic Curves

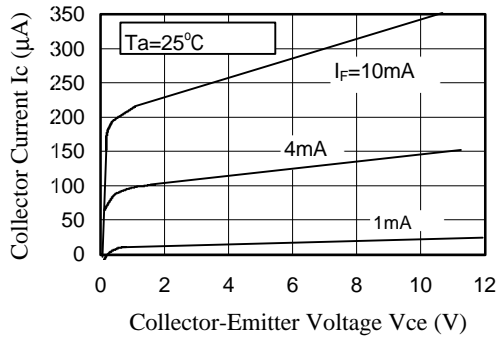

Fig.5 Collector Current vs. Vce

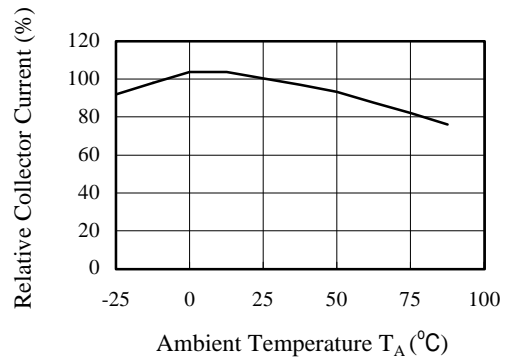

Fig.6 Relative Collector Current vs. Ambient Temperature TA (°C)

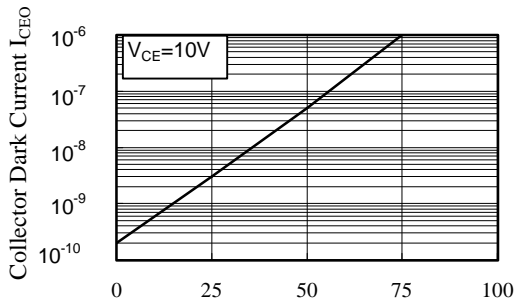

Fig.7 Collector Dark Current vs. Ambient Temperature

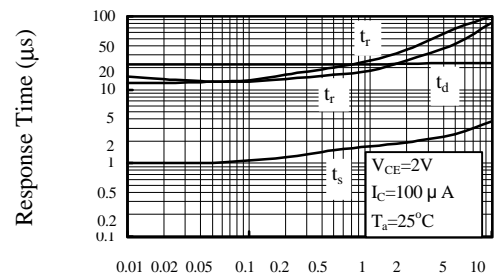

Fig.8 Response Time vs. Load Resistance

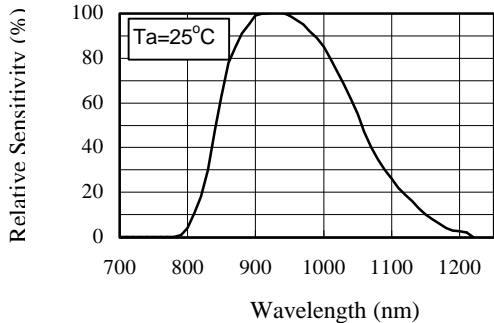

Fig.9 Spectral Sensitivity (Detecting side)

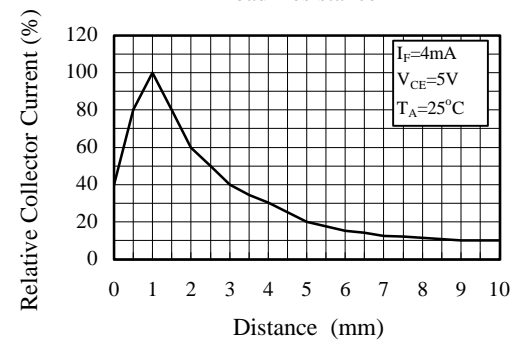

Fig.10 Relative Collector Current vs. Distance between MIR-3301 and Card

Test Circuit for Response Time

