

**LA2010****Audio Level Sensor****Overview**

The LA2010 is an IC for detecting interprogram spaces to pick out the starting point of a program immediately preceding or following musical program recorded on tape.

Applicable Sets

- Radio-cassette recorders.
- Cassette decks.
- Car stereos.

Application

- Detection of spaces between programs recorded on tape.

Features

- Built-in transistor capable of driving plunger with 600mA max. and protective diode to prevent induced reverse voltage.
- Capable of desired timing setting by using external C, R.
- Detects unrecorded areas of tape and drives plunger.
- Built-in preventer to prevent plunger from malfunctioning at the time of application of power.
- Built-in detector to detect recorded area.

Package Dimensions

unit:mm

3017C-SIP9

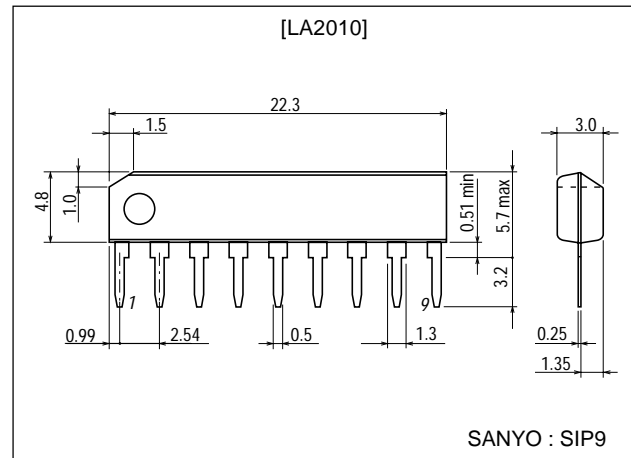
**Specifications****Maximum Ratings** at $T_a = 25^\circ\text{C}$

Parameter	Symbol	Conditions	Ratings	Unit
Maximum supply voltage	V_{CC} max		15	V
Flow-in current	I_G max		600	mA
Allowable power dissipation	P_d max		540	mW
Operating temperature	T_{opr}		-20 to +75	$^\circ\text{C}$
Storage temperature	T_{stg}		-40 to +125	$^\circ\text{C}$

- Note)
- The voltage on pin 1 must not exceed the voltage on pin 9.
 - The current flowing into pin 2 and pin 4 must not exceed $\pm 0.5\text{mA}$ continuously.
 - The voltage on pin 8 is 2.5V max. and must not exceed the voltage on pin 7.

■ Any and all SANYO products described or contained herein do not have specifications that can handle applications that require extremely high levels of reliability, such as life-support systems, aircraft's control systems, or other applications whose failure can be reasonably expected to result in serious physical and/or material damage. Consult with your SANYO representative nearest you before using any SANYO products described or contained herein in such applications.

■ SANYO assumes no responsibility for equipment failures that result from using products at values that exceed, even momentarily, rated values (such as maximum ratings, operating condition ranges, or other parameters) listed in products specifications of any and all SANYO products described or contained herein.

SANYO Electric Co.,Ltd. Semiconductor Company

TOKYO OFFICE Tokyo Bldg., 1-10, 1 Chome, Ueno, Taito-ku, TOKYO, 110-8534 JAPAN

LA2010

Recommended Operating Conditions at Ta = 25°C

Parameter	Symbol	Conditions	Ratings	Unit
Recommended supply voltage	V _{CC}		9	V
Operating voltage range	V _{CC op}		3.5 to 14	V

Operating Characteristics at Ta = 25°C, V_{CC}=9.0V, f=1kHz

Parameter	Symbol	Conditions	Ratings			Unit
			min	typ	max	
Circuit current	I _{CC}	f=1kHz, V _{IN} =-30dB		11	22	mA
Output transistor saturation voltage	V _{CE(Sat)}	I ₆ =600mA		1.1	1.6	V
Output diode forward voltage	V _F	I _F =600mA		1.5	2.0	V
Input check level	V _{IN}	f=1kHz, Pin 6 L → H	-47	-50	-53	dB
Comparator (1) ON level	V _{TH1-H}	Pin 6 inverted	3.0	3.5	4.0	V
Comparator (1) OFF level	V _{TH1-L}	Pin 6 inverted	1.8	2.2	2.6	V
Comparator (2) ON level	V _{TH2-H}	Pin 6 inverted	4.7	5.5	6.3	V
Comparator (2) OFF level	V _{TH2-L}	Pin 6 inverted	3.6	4.0	4.6	V
Pin 4 reset level	V _{4R}	f=1kHz, V _{IN} =-30dB, pin 8=1.0V		0.02	0.1	V
Pin 8 reset voltage-1	V _{8R-1}	Pin 1 inverted, R _g =0	0.6	0.7	0.8	V
Pin 8 reset voltage-2	V _{8R-2}	f=1kHz, V _{IN} =-30dB, pin 4 inverted	1.1	1.3	1.5	V

1. Description of external parts

- C1 : Input coupling capacitor
Capacitor used for coupling with preceding preamp. Characteristics at the time of application of power considered, the capacitance value of C1 must not exceed that of C3 on pin 3. 0.047μF (polyester film capacitor) is recommended. R1, R2 are used to adjust the input level. Pin 1 is high in input impedance ; in order to be free from external effect, R2 must not exceed 10kΩ and must be grounded.

- C2, R3 : For setting interprogram space detect time (TD)
By selecting proper C2 and R3, your desired TD can be obtained.
TD=1.34×C2 · R3 (s)
It is recommended to use R3 of 150kΩ to 500kΩ.
It is recommended to use C2 of 0.22μF (polyester film capacitor).

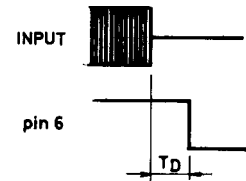

- C3 : NF capacitor
Lower cut-off frequency f_L depends on this capacitor.

$$f_L = \frac{1}{0.3\pi C3 (\mu F)} \dots\dots\dots (\text{kHz})$$

Assuming C3=0.47μF, f_L=2.2kHz is obtained. If the capacitance value of C3 is increased, f_L lowers, thereby being subjected to the effect of the variations in preamp. Further, since the time that elapses between the moment V_{CC} is applied and the moment the circuit is stabilized becomes longer, the reset time must be made longer accordingly. Therefore, it is recommended to use C3 of 0.47μF.

- C4, R4 : For setting recorded area detect time (TS)
The presence or absence of a program (input signal) is checked by the time setting determined by C4, R4 as follows :

- For recorded area T_S < T_I + T_D
- For unrecorded area T_S > T_I + T_D

The recorded area detect time is set by :

$$T_S = C4 (\mu F) R4 (k\Omega) (\text{ms})$$

Therefore, if the recorded area detect time (TS) is longer than the input signal time (TI) + the unrecorded area detect time (TD), no program is present. The resistance value of R4 must be 50kΩ to 200kΩ ; it is recommended to use R4 of 100kΩ. The capacitance value of C4 must not exceed 4.7μF ; it is recommended to use C4 of 1μF to 3.3μF.

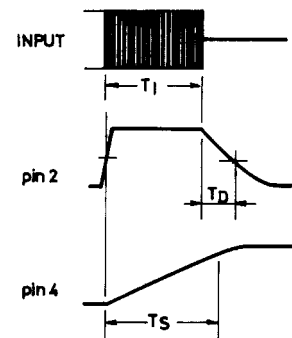

- C5 : For setting reset time
Capacitor used to set the time for initializing the circuit at the time of application of power. The reset pulse is generated for a certain period of time $[TR=14.4 \cdot C5 (\mu F) (ms)]$ that is set each time power is applied.
- C6, R5 : For power ripple filter.

Description of Operatin (See Timing Chart.)

When power is applied, the reset circuit operates to initialize the circuit. The reset time depends on the capacitance value of C5 on pin 8 and no input signal is accepted while the reset circuit is operating. When the reset mode is released and the input signal exceeds the input check level, C, R on pin 2 are charged and the pontential on pin 2 rises, thereby causing the comparator (1) to be inverted. When the comparator (1) is inverted, pin 4 (C4) is charged and the potential on pin 4 begins rising. When this potential exceeds the threshold voltage, the comparator (2) is inverted and the program presence mode is memorized ; thus the potential on pin 4 is held at High level. During this period of time, the output (pin 6) is held at High level. When the signal disappears and the comparator (1) is inverted, the output (pin 6) turns to Low level, thereby causing the plunger to be driven. The reset pulse is generated for a certain period of time each time power is applied, thereby causing the circuit to be initialized.

Timing Chart

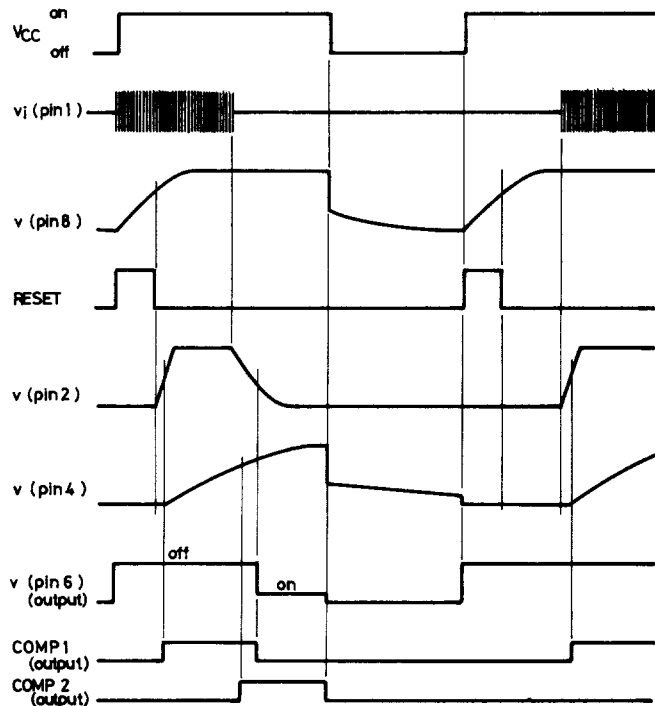

Proper Cares in Using IC

- Maximum Ratings
If the maximum ratings are exceeded, breakdown or deterioration may result. Use the IC in the range where the maximum ratings are not exceeded.
- Pin-to-pin Short and Inverted Insertion
These may cause breakdown or deterioration to occur. Be extremely careful when mounting the IC on the board.
- The voltage on pin 1 must not exceed that on pin 9.
- The current flowing into pin 2 and pin 4 must not exceed $\pm 0.5mA$ continuously.
- The voltage on pin 8 is 2.5V max. and must not exceed that on pin 7.
- Electrolytic capacitors are used to set the recorded area detect time and reset time. The actual time constants are 15 to 20% larger than the calculated values obtained by using the catalon values of such capacitors. For polyester film capacitor and tantalum electrolytic capacitor, the calculated values hold to a fairly good approximation.

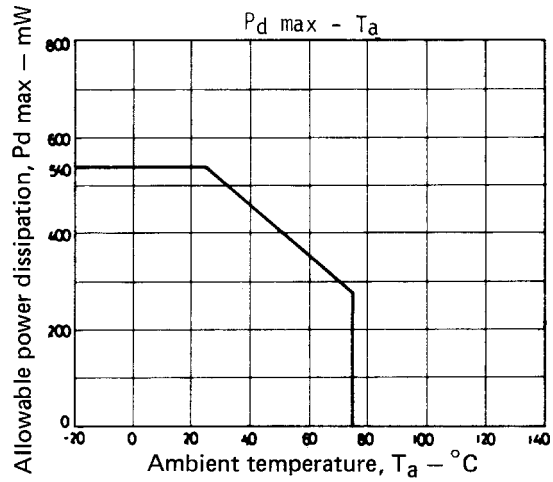
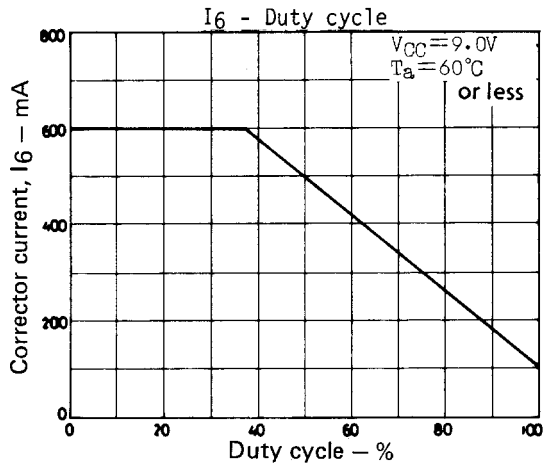

Note) Continuous application of I_C = 600 mA: Within 3 s.

Test Circuit

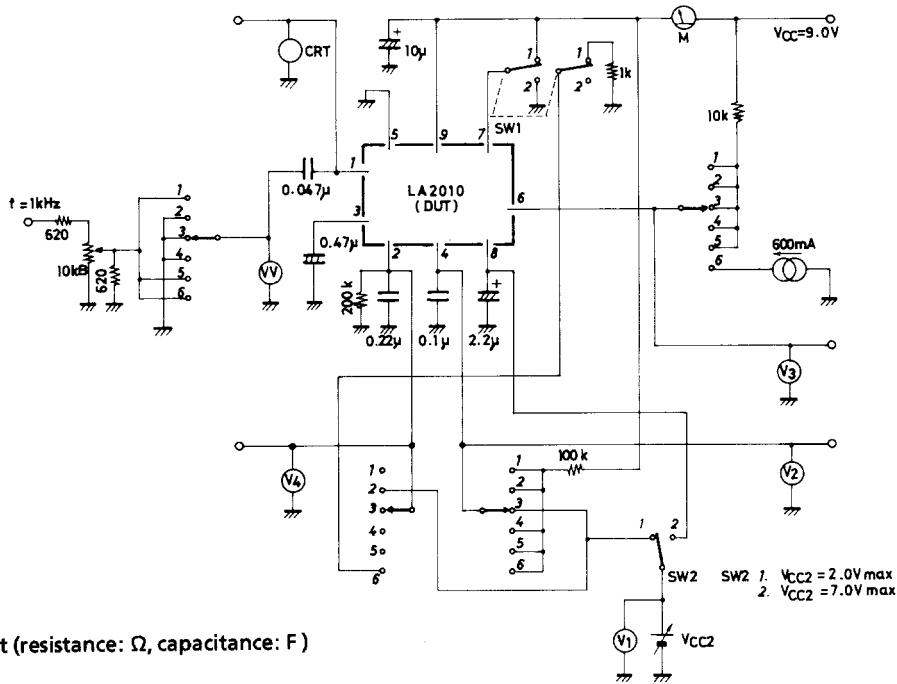

Unit (resistance: Ω, capacitance: F)

Test Item	Symbol	Rotary SW	SW-1	SW-2	Conditions
Input check level	V _{IN}	1	1	1	Measure AC input level VV at pin 6 L → H inversion mode.
Comparator (1) ON level	V _{TH1-H}	2	1	1	Measure pin 2 V ₄ at pin 6 L → H inversion mode.
Comparator (1) OFF level	V _{TH1-L}	2	1	1	Measure pin 2 V ₄ at pin 6 H → L inversion mode.
Comparator (2) ON level	V _{TH2-H}	3	1	1	Measure pin 4 V ₂ at pin 6 H → L inversion mode.
Comparator (2) OFF level	V _{TH2-L}	3	1	1	Measure pin 4 V ₂ at pin 6 L → H inversion mode.
Pin 8 reset voltage 1	V _{8R-1}	4	1	2	Measure V ₁ voltage at pin 1 inversion mode.
Pin 8 reset voltage 2	V _{8R-2}	5	1	2	Measure V ₁ voltage at pin 4 inversion mode.
Pin 4 reset level	V _{4R}	5	1	2	Measure pin 4 voltage V ₂ at V ₁ =1V.
Circuit current	I _{CC}	5	1	1	Measure supply current.
Output transistor saturation voltage	V _{CE(sat)}	6	1	1	Measure pin 6 voltage V ₃ at 600mA.
Output diode saturation voltage	V _F	6	2	1	Measure pin 6 voltage V ₃ at 600mA.

LA2010

Equivalent Circuit Block Diagram

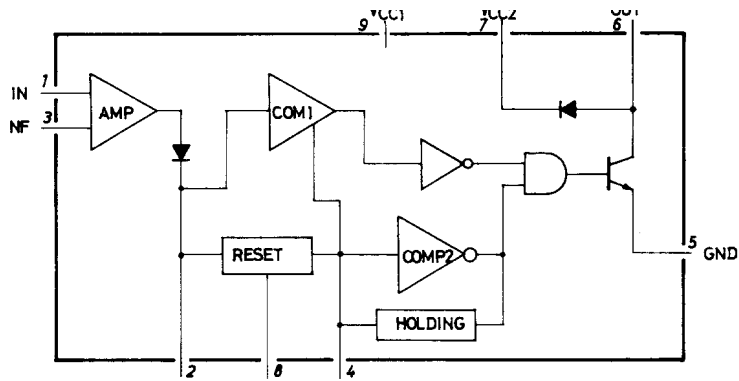

Sample Application Circuit

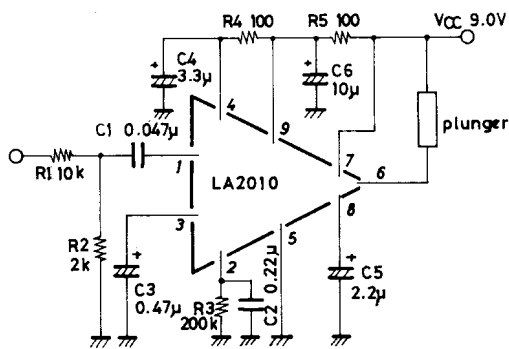

Unit (resistance: Ω , capacitance: F)

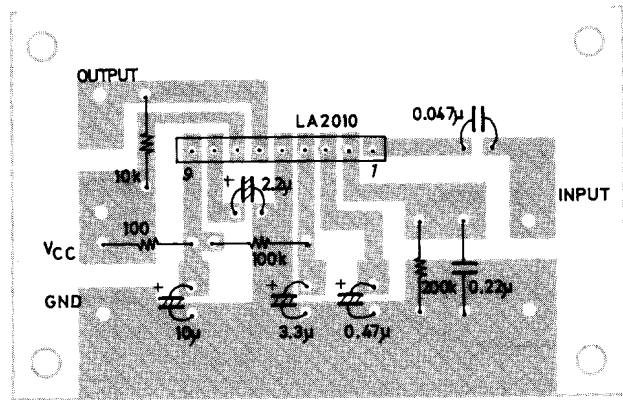

Sample Printed Circuit Pattern
(Cu-foiled area)

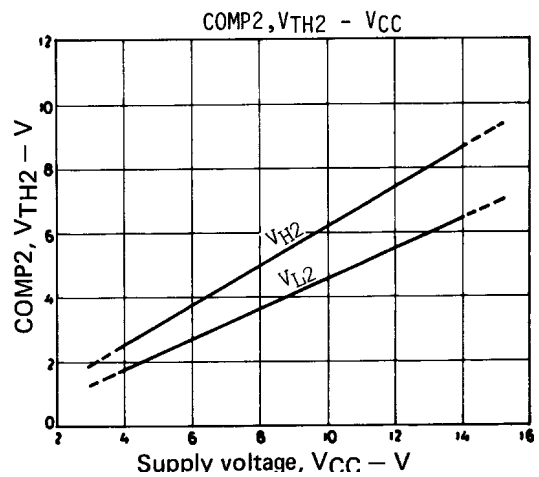
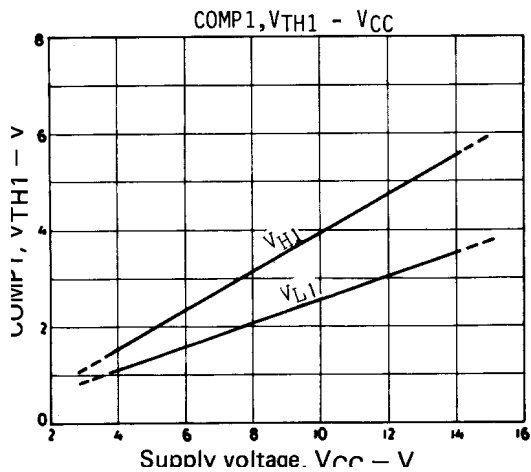

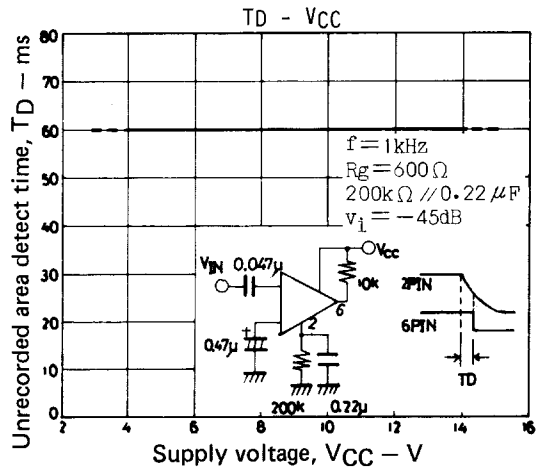
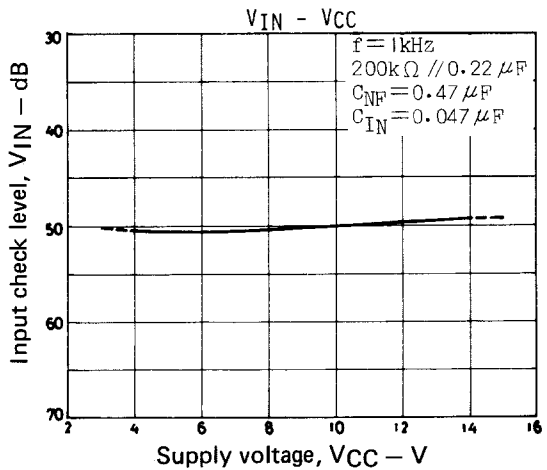
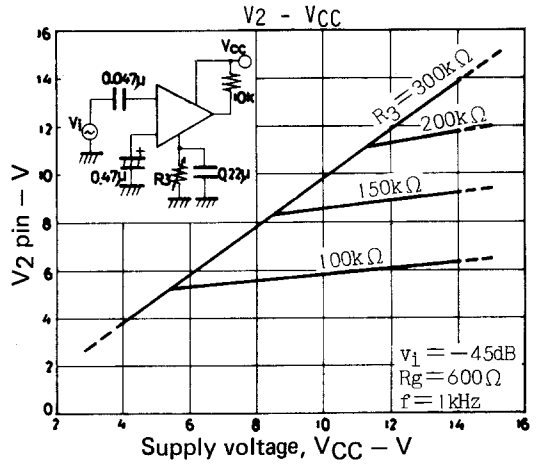
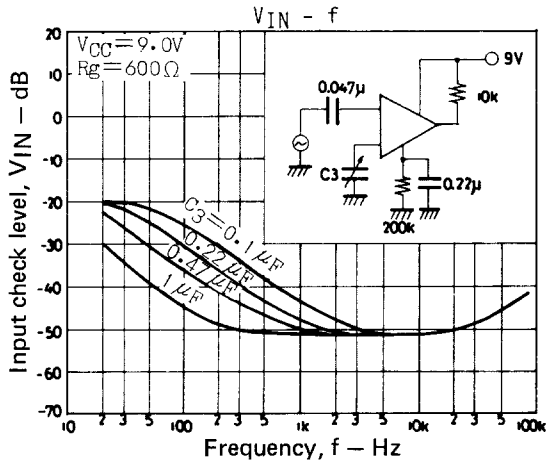
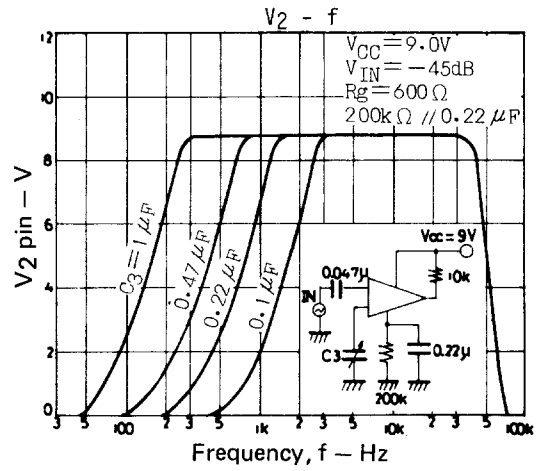
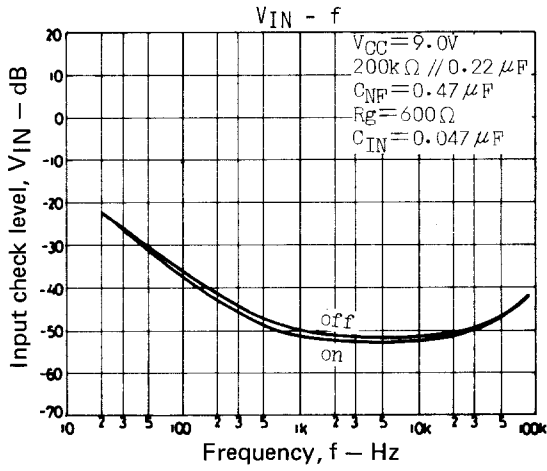
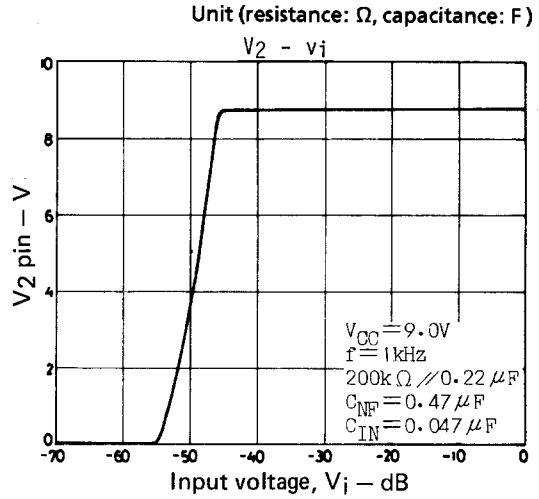
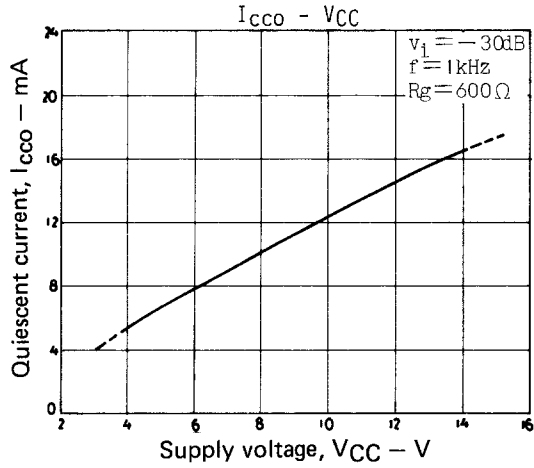

Unit (resistance: Ω , capacitance: F)

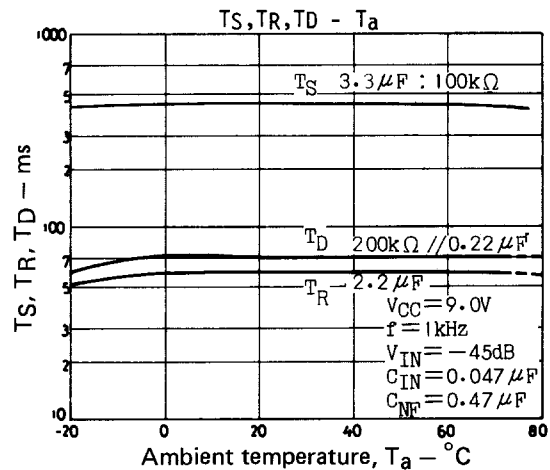
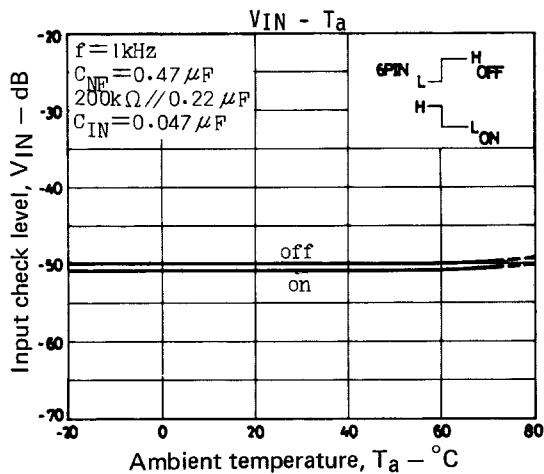
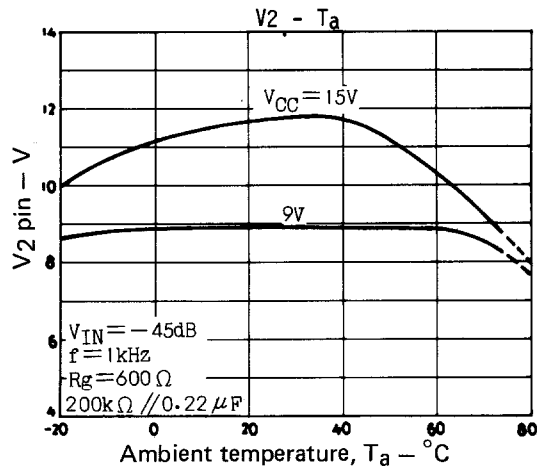
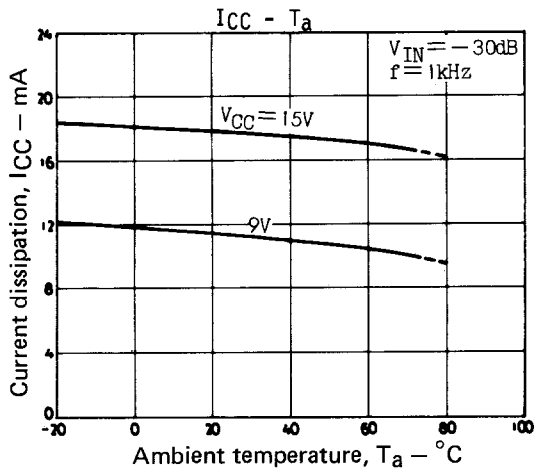
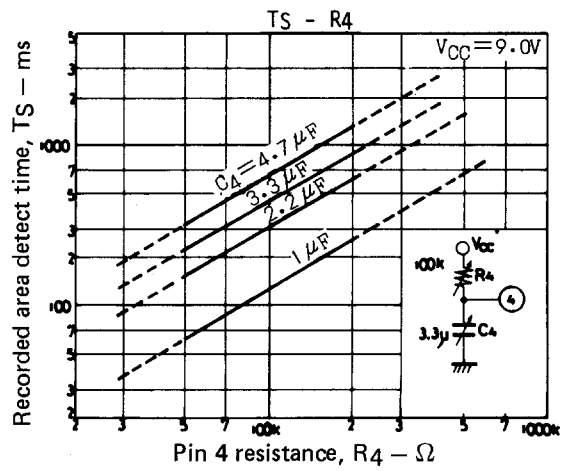
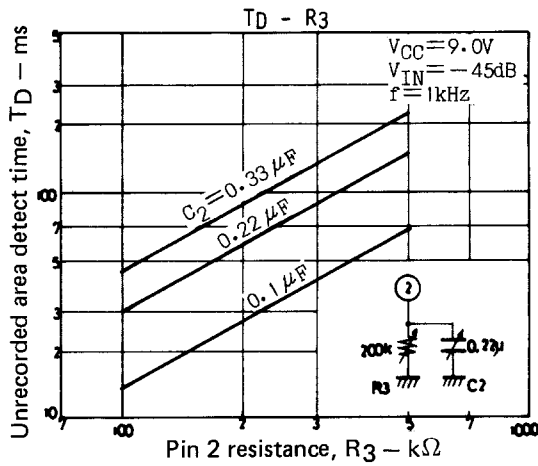
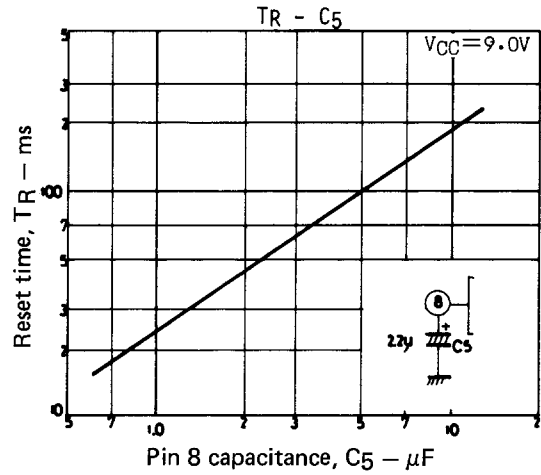
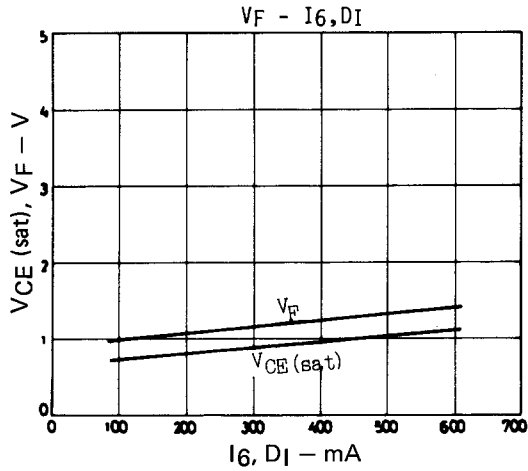

- Specifications of any and all SANYO products described or contained herein stipulate the performance, characteristics, and functions of the described products in the independent state, and are not guarantees of the performance, characteristics, and functions of the described products as mounted in the customer's products or equipment. To verify symptoms and states that cannot be evaluated in an independent device, the customer should always evaluate and test devices mounted in the customer's products or equipment.
- SANYO Electric Co., Ltd. strives to supply high-quality high-reliability products. However, any and all semiconductor products fail with some probability. It is possible that these probabilistic failures could give rise to accidents or events that could endanger human lives, that could give rise to smoke or fire, or that could cause damage to other property. When designing equipment, adopt safety measures so that these kinds of accidents or events cannot occur. Such measures include but are not limited to protective circuits and error prevention circuits for safe design, redundant design, and structural design.
- In the event that any or all SANYO products(including technical data, services) described or contained herein are controlled under any of applicable local export control laws and regulations, such products must not be exported without obtaining the export license from the authorities concerned in accordance with the above law.
- No part of this publication may be reproduced or transmitted in any form or by any means, electronic or mechanical, including photocopying and recording, or any information storage or retrieval system, or otherwise, without the prior written permission of SANYO Electric Co., Ltd.
- Any and all information described or contained herein are subject to change without notice due to product/technology improvement, etc. When designing equipment, refer to the "Delivery Specification" for the SANYO product that you intend to use.
- Information (including circuit diagrams and circuit parameters) herein is for example only ; it is not guaranteed for volume production. SANYO believes information herein is accurate and reliable, but no guarantees are made or implied regarding its use or any infringements of intellectual property rights or other rights of third parties.

This catalog provides information as of January, 2000. Specifications and information herein are subject to change without notice.