

CS1087

Vacuum Fluorescent Display Tube Driver

The VFD Driver is a microprocessor interface IC that drives a multiplexed VF (Vacuum Fluorescent) display tube. It consists of a 32-bit shift register, a 32-bit transparent data latch, a metal mask ROM, six 20 mA anode output drivers, twenty-three 2 mA anode output drivers, and three 50 mA grid drivers with output enables.

Features

- Power On Reset
- Display Dimming Possible
- Three, 50 mA Grid Drivers
- Anode Options – DIP-40 and PCLL-44:
 - 6 @ 20 mA
 - 23 @ 2 mA
- Anode Options – SO-28L:
 - 3 @ 20 mA
 - 15 @ 2 mA

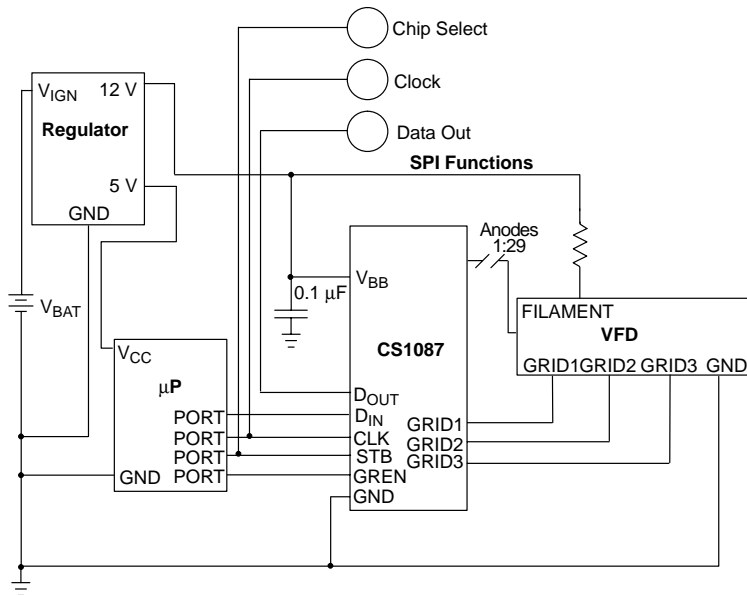
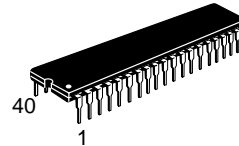

Figure 1. Application Diagram



ON Semiconductor™

<http://onsemi.com>



DIP-40
WIDE BODY
N SUFFIX
CASE 711

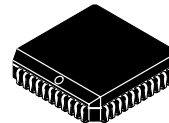

PLCC-44
FN SUFFIX
CASE 777

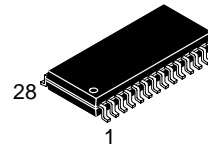

SO-28L
DW SUFFIX
CASE 751F

ORDERING INFORMATION*

Device	Package	Shipping
CS1087XN40	DIP-40 WIDE BODY	9 Units/Rail
CS1087XFN44	PLCC-44	23 Units/Rail
CS1087XFNR44	PLCC-44	500 Tape & Reel
CS1087XDW28	SO-28L	27 Units/Rail
CS1087XDWR28	SO-28L	1000 Tape & Reel

*For additional package options, consult your local ON Semiconductor sales office.

DEVICE MARKING INFORMATION

See general marking information in the device marking section on page 7 of this data sheet.

CS1087

MAXIMUM RATINGS*

Parameter	Value	Unit
Supply Voltage (V_{BB})	-0.6 to +18	V
Input Voltages (D_{IN} , CLK, STB, GREN)	-0.6 to +6.0	V
Junction Temperature Range	-40 to +150	°C
Storage Temperature Range	-55 to +150	°C
ESD Susceptibility (Human Body Model)	2.0	kV
ESD Susceptibility (Machine Model)	200	V
Package Thermal Resistance, DIP-40 Junction-to-Case, $R_{\theta JC}$ Junction-to-Ambient, $R_{\theta JA}$	20 45	°C/W °C/W
Package Thermal Resistance, PLCC-44 Junction-to-Case, $R_{\theta JC}$ Junction-to-Ambient, $R_{\theta JA}$	16 55	°C/W °C/W
Package Thermal Resistance, SO-28L Junction-to-Case, $R_{\theta JC}$ Junction-to-Ambient, $R_{\theta JA}$	15 75	°C/W °C/W
Lead Temperature Soldering:	Wave Solder (through hole styles only) Note 1 Reflow (SMD styles only) Note 2	260 Peak 230 Peak °C

1. 10 second maximum.

2. 60 second maximum above 183°C.

*The maximum package power dissipation must be observed.

ELECTRICAL CHARACTERISTICS (8.0 V ≤ V_{BB} ≤ 16.5 V, Gnd = 0 V, -40°C ≤ T_J ≤ 105°C; unless otherwise stated. Note 3.)

Parameter	Test Conditions	Min	Typ	Max	Unit
-----------	-----------------	-----	-----	-----	------

V_{BB} Input

V_{BB} Input Voltage	-	8.0	-	16.5	V
I_{BB0} Current	No outputs active, $V_{BB} = 16.5$ V	-	2.0	5.0	mA
Reset Mode	All outputs forced low.	-	6.5	7.5	V

D_{IN} , CLK, STB Inputs

V_{IL1} , Input Low Voltage	-	-	-	1.6	V
V_{IH} , Input High Voltage	-	3.3	-	-	V
I_{IL} , Input Current	$V_{IN} = V_{IH}$	-	7.5	20.0	μA

GREN Input

V_{IL} , Input Low Voltage	-	-	-	1.6	V
V_{IH} , Input High Voltage	-	3.3	-	-	V
I_{IH} , Input Pull-down Current	$V_{IN} = 3.325$ V	-	30	60	μA

GRID1, GRID2, GRID3 Outputs

I_{OL}	Sink Current	1.0	-	-	mA
I_{OH}	Source Current	50	-	-	mA
V_{OL}	$I_{OUT} = 1.0$ mA	-	-	0.5	V
V_{OH}	$I_{OUT} = -50$ mA, $V_{BB} = 12$ V	$V_{BB} - 0.75$	-	V_{BB}	V

3. Designed to meet these characteristics over the stated voltage and temperature ranges, though may not be 100% parametrically tested in production.

CS1087

ELECTRICAL CHARACTERISTICS (continued) ($8.0\text{ V} \leq V_{\text{BB}} \leq 16.5\text{ V}$, $\text{Gnd} = 0\text{ V}$, $-40^\circ\text{C} \leq T_{\text{J}} \leq 105^\circ\text{C}$; unless otherwise stated. Note 4.)

Parameter	Test Conditions	Min	Typ	Max	Unit
-----------	-----------------	-----	-----	-----	------

AN24 – AN29 Outputs

I_{OL}	Sink Current	400	–	–	μA
I_{OH}	Source Current	20	–	–	mA
V_{OL}	$I_{\text{OUT}} = 400\ \mu\text{A}$	–	–	0.5	V
V_{OH}	$I_{\text{OUT}} = -20\ \text{mA}$, $V_{\text{BB}} = 12\ \text{V}$	$V_{\text{BB}} - 0.5$	–	V_{BB}	V

AN1 – AN23 Outputs

I_{OL}	Sink Current	100	–	–	μA
I_{OH}	Source Current	2.0	–	–	mA
V_{OL}	$I_{\text{OUT}} = 100\ \mu\text{A}$	–	–	0.5	V
V_{OH}	$I_{\text{OUT}} = -2.0\ \text{mA}$, $V_{\text{BB}} = 12\ \text{V}$	$V_{\text{BB}} - 0.5$	–	V_{BB}	V

DOUT Output

I_{OL}	Sink Current	1.0	–	–	mA
I_{OH}	Source Current	1.0	–	–	mA
V_{OL}	$I_{\text{OUT}} = 1.0\ \text{mA}$	–	–	0.5	V
V_{OH}	$I_{\text{OUT}} = -1.0\ \text{mA}$	3.9	–	5.1	V

AC Characteristics: Input and Output Timing

F_{C} , CLK Frequency	–	0	–	1.0	MHz
T_{CL} , CLK Low Time	–	200	–	–	ns
T_{CH} , CLK High Time	–	200	–	–	ns
T_{CR} , CLK Rise Time	–	–	–	100	ns
T_{CF} , CLK Fall Time	–	–	–	100	ns
T_{CD} , CLK Low to D _{OUT} Propagation Delay	–	–	–	200	ns
T_{SC} , STB Low to CLK High Time	–	50	–	–	ns
T_{ST} , STB High Time	–	500	–	–	ns
T_{AN} , STB High to Anode Output Propagation Delay	–	–	–	5.0	μs
T_{GL} , Grid Turn On Propagation Delay	$V_{\text{BB}} = 12\ \text{V}$	–	–	2.0	μs
T_{GO} , Grid Turn Off Propagation Delay	$V_{\text{BB}} = 12\ \text{V}$	–	–	5.0	μs
T_{GR} , Grid Rise Time	At rated load. Note 5.	0.50	–	2.00	μs
T_{GF} , Grid Fall Time	At rated load. Note 5.	0.35	–	2.00	μs
T_{AR} , Anode Rise Time	At rated load. Note 5.	0.40	–	2.00	μs
T_{AF} , Anode Fall Time	At rated load. Note 5.	0.40	–	2.50	μs

4. Designed to meet these characteristics over the stated voltage and temperature ranges, though may not be 100% parametrically tested in production.
5. Grid and anode rise/fall times are measured from 10% and 90% points. Output currents are at the maximum rated currents for the respective stages.

CS1087

PACKAGE LEAD DESCRIPTION

Package Lead Number			Lead Symbol	Function
40L DIP	44L PLCC	SO-28L	(29 Anode Configuration)	
1	14	1	GRID1	50 mA grid output.
2	15	2	GRID2	50 mA grid output.
3	16	3	GRID3	50 mA grid output.
4	17	–	AN1	2.0 mA anode output.
5	18	4	AN2	2.0 mA anode output.
6	19	5	AN3	2.0 mA anode output.
7	20	6	AN4	2.0 mA anode output.
8	21	–	AN5	2.0 mA anode output.
9	22	7	AN6	2.0 mA anode output.
10	24	–	AN7	2.0 mA anode output.
11	25	–	AN8	2.0 mA anode output.
12	26	8	AN9	2.0 mA anode output.
13	27	–	AN10	2.0 mA anode output.
14	28	9	AN11	2.0 mA anode output.
15	29	10	AN12	2.0 mA anode output.
16	30	11	AN13	2.0 mA anode output.
17	31	12	AN14	2.0 mA anode output.
18	32	13	AN15	2.0 mA anode output.
19	33	–	AN16	2.0 mA anode output.
20	35	14	GND	Ground connection.
21	36	15	AN17	2.0 mA anode output.
22	37	–	AN18	2.0 mA anode output.
23	38	16	AN19	2.0 mA anode output.
24	39	17	AN20	2.0 mA anode output.
25	40	18	AN21	2.0 mA anode output.
26	41	19	AN22	2.0 mA anode output.
27	42	–	AN23	2.0 mA anode output.
28	43	20	AN24	20 mA anode output.
29	44	21	AN25	20 mA anode output.
30	2	22	AN26	20 mA anode output.
31	3	–	AN27	20 mA anode output.
32	4	–	AN28	20 mA anode output.
33	5	–	AN29	20 mA anode output.
34	6	23	D _{OUT}	Shift register data output.
35	7	24	D _{IN}	Shift register data input.
36	8	25	CLK	Shift register clock input.
37	9	26	STB	Transfer contents of shift registers to output stages.
38	10	27	GREN	Grid outputs enable.
39	1, 11, 12, 23, 34	–	NC	No connection.
40	13	28	V _{BB}	Supply voltage input.

CS1087

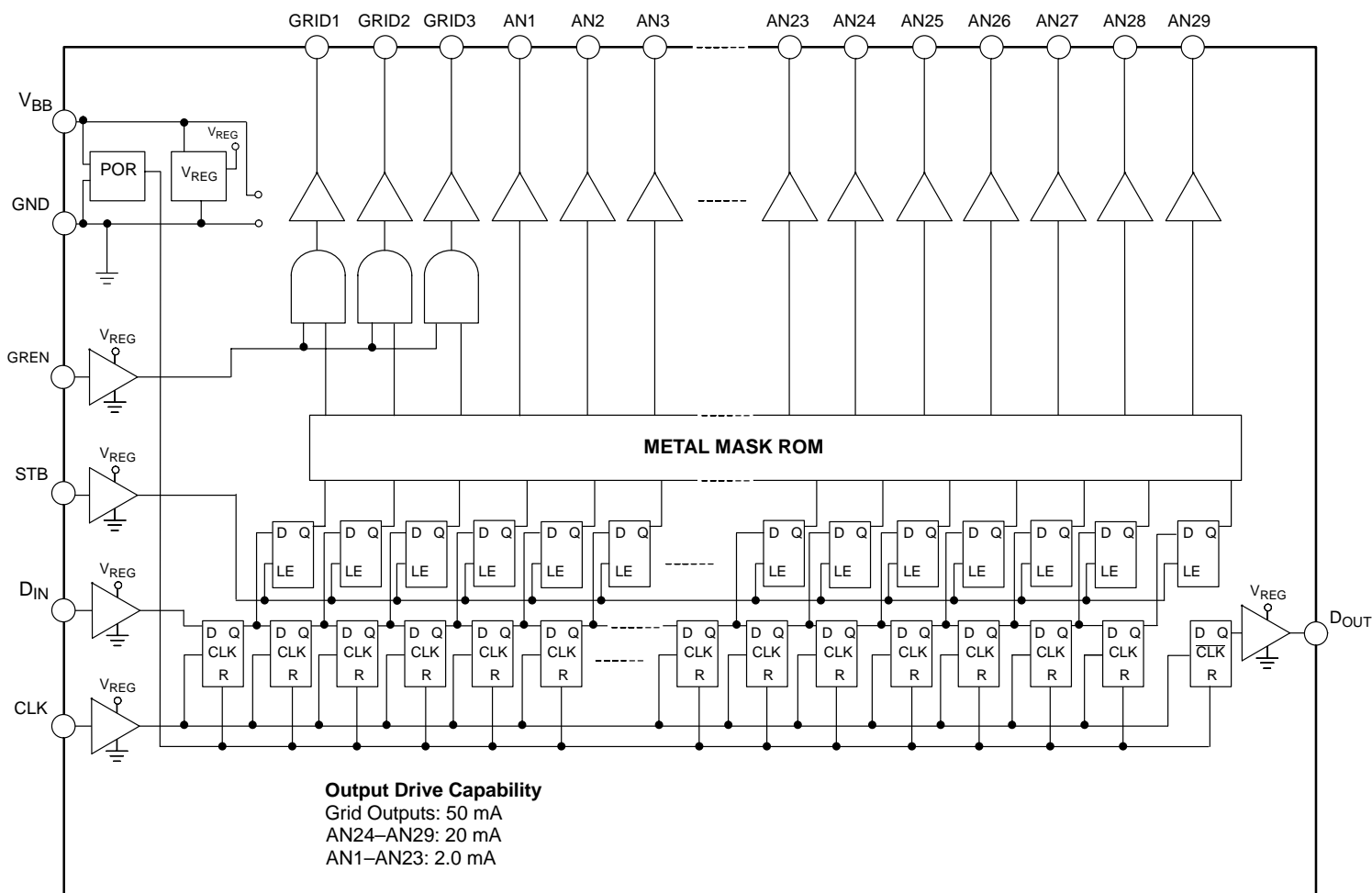

Figure 2. Block Diagram

OPERATION DESCRIPTION

Upon the initial application of power, the power on reset function will cause all of the anode and grid driver outputs to be off and all shift register outputs to be set low. Data is fed into the shift register through the D_{IN} pin at the rising edge of the CLK input. Thirty two bits of data are capable of being stored by the shift register. Once the desired pattern is stored in the shift register, it can be transferred to the latch by setting the STB input high. The output of each latch drives its corresponding output stage. A logic high input to the shift register/latch will cause the corresponding output to turn on. A logic low input to the shift register/latch will cause the corresponding output to turn off. Please note that if the STB is held high, the outputs of the latch reflect the outputs of the corresponding shift register bits and will change if data is shifted in.

The three $GRID$ outputs are gated by the $GREN$ input. When $GREN$ is low, the $GRID$ outputs are forced low regardless of the state of the corresponding latch output. When $GREN$ is high, the $GRID$ outputs correspond to the state of their respective latch outputs. The anode outputs, $AN1$ to $AN29$ are always enabled.

The D_{OUT} pin is the output of the last stage of the shift register to allow serial cascading of this IC with other devices. Data from the last stage of the shift register is supplied to the D_{OUT} pin delayed by 1/2 CLK cycle. Data on the D_{OUT} output changes with the falling edges of the CLK to prevent logic race conditions between the CLK and the D_{IN} of the next IC in the serial chain.

APPLICATION INFORMATION

Table 1. Bit Pattern, G = Grid, A = Anode.

Bit #	1	2	3	4	5	6	7	8	9	10	11	12	13	14	15	16
Pin Name	G1	G2	G3	A1	A2	A3	A4	A5	A6	A7	A8	A9	A10	A11	A12	A13

Bit #	17	18	19	20	21	22	23	24	25	26	27	28	29	30	31	32
Pin Name	A14	A15	A16	A17	A18	A19	A20	A21	A22	A23	A24	A25	A26	A27	A28	A29

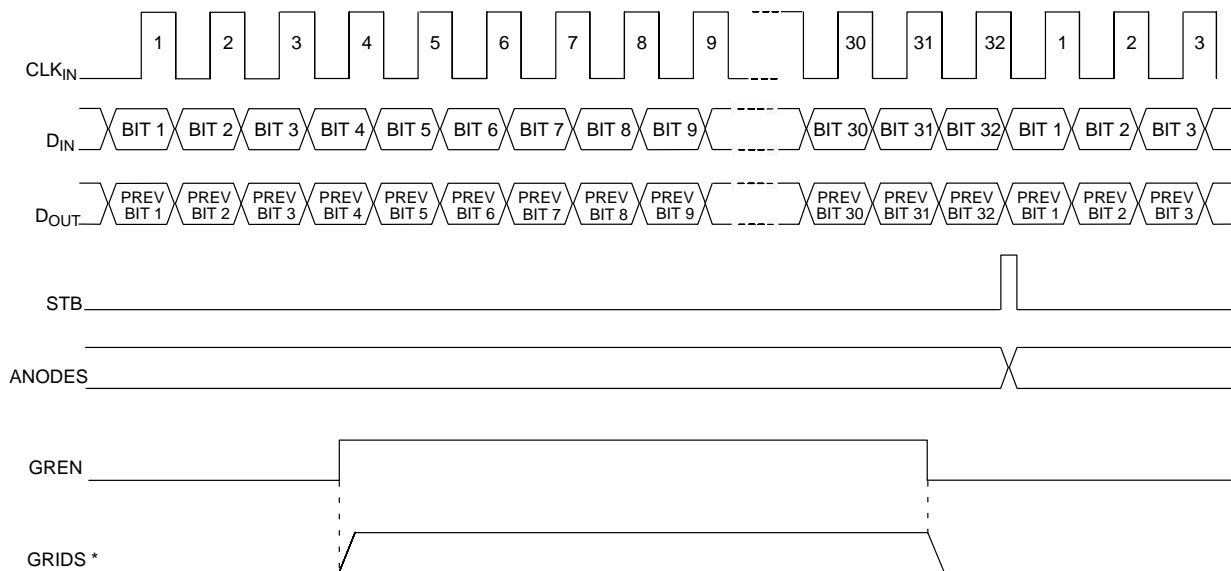

* Selected grid goes high only if input bit pattern from shift register to grid is high.

Figure 3. Typical Operation

Unused grid and anode drivers should have their respective bits set to logic low in the data stream.

Multiple grid or anode drivers may be connected together, but must be programmed to the same logic state for proper device operation. Maximum package power must be observed and care must be taken to maintain junction temperature below +150°C.

Care must be taken when interfacing this part to a microprocessor. The D_{OUT} output V_{OH} is specified at 3.9 V

to 5.1 V at an I_{OUT} of -1.0 mA. Lower current loads will result in a higher output voltage. V_{OH} = 5.2 V (typ) with no load. V_{OH} = 5.7 V (max) with no load. Protection or workarounds for the device may be needed at the application level. No protection is needed when interfacing with other parts in this family (CS1087, CS1088, or CS1089).

CS1087

MARKING DIAGRAMS



**DIP-40
WIDE BODY
N SUFFIX
CASE 711**



**PLCC-44
FN SUFFIX
CASE 777**

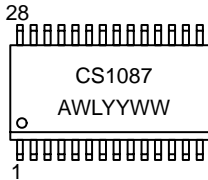

**SO-28L
DW SUFFIX
CASE 751F**

A = Assembly Location
 WL, L = Wafer Lot
 YY, Y = Year
 WW, W = Work Week

PIN CONNECTIONS

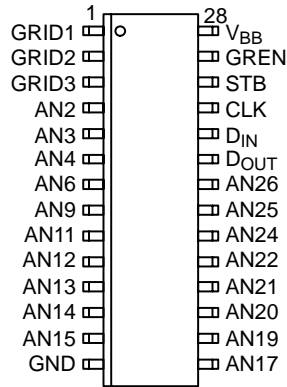
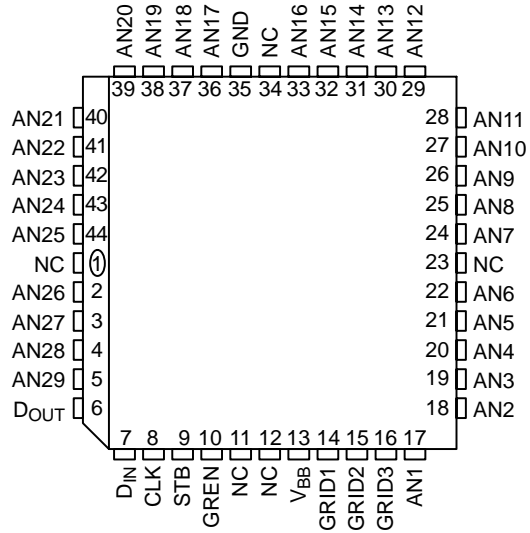
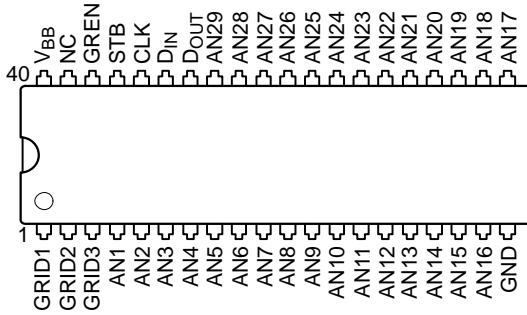

CS1087

PACKAGE DIMENSIONS

DIP-40
WIDE BODY
N SUFFIX
CASE 711-03
ISSUE C

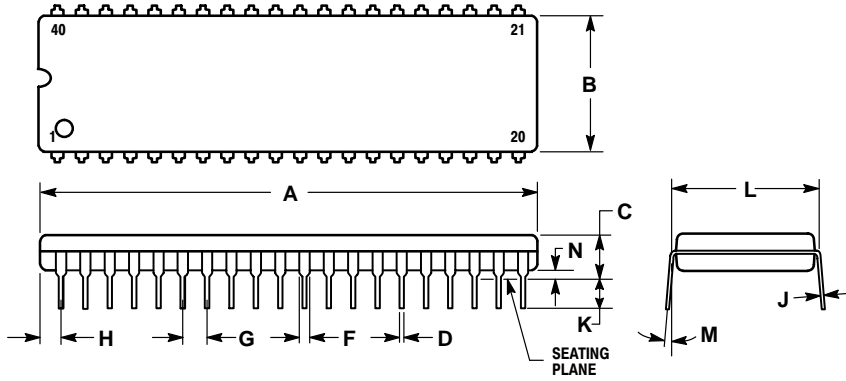

NOTES:

1. POSITIONAL TOLERANCE OF LEADS (D), SHALL BE WITHIN 0.25 (0.010) AT MAXIMUM MATERIAL CONDITION, IN RELATION TO SEATING PLANE AND EACH OTHER.
2. DIMENSION L TO CENTER OF LEADS WHEN FORMED PARALLEL.
3. DIMENSION B DOES NOT INCLUDE MOLD FLASH.

DIM	MILLIMETERS		INCHES	
	MIN	MAX	MIN	MAX
A	51.69	52.45	2.035	2.065
B	13.72	14.22	0.540	0.560
C	3.94	5.08	0.155	0.200
D	0.36	0.56	0.014	0.022
F	1.02	1.52	0.040	0.060
G	2.54 BSC		0.100 BSC	
H	1.65	2.16	0.065	0.085
J	0.20	0.38	0.008	0.015
K	2.92	3.43	0.115	0.135
L	15.24 BSC		0.600 BSC	
M	0°	15°	0°	15°
N	0.51	1.02	0.020	0.040

CS1087

PACKAGE DIMENSIONS

PLCC-44
FN SUFFIX
CASE 777-02
ISSUE C

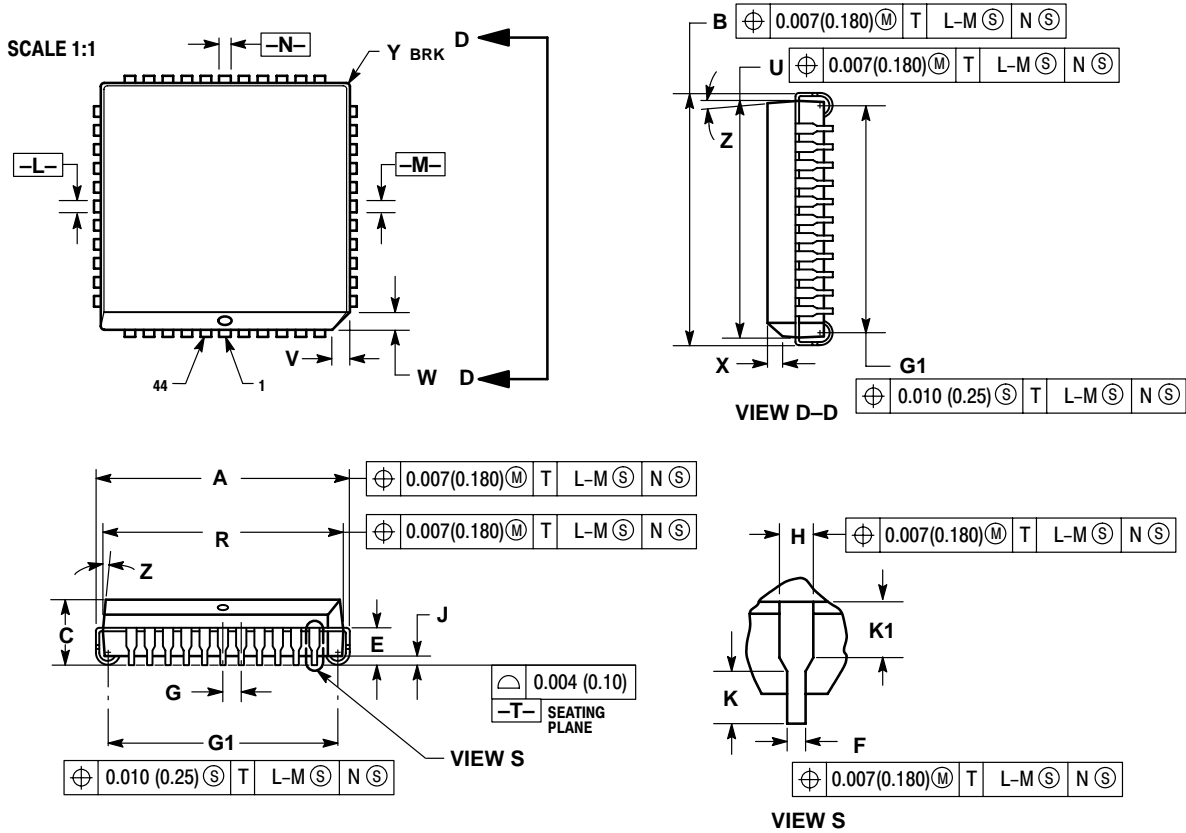

NOTES:

- DATUMS -L-, -M-, AND -N- ARE DETERMINED WHERE TOP OF LEAD SHOULDER EXITS PLASTIC BODY AT MOLD PARTING LINE.
- DIMENSION G1, TRUE POSITION TO BE MEASURED AT DATUM -T-, SEATING PLANE.
- DIMENSIONS R AND U DO NOT INCLUDE MOLD FLASH. ALLOWABLE MOLD FLASH IS 0.010 (0.25) PER SIDE.
- DIMENSIONING AND TOLERANCING PER ANSI Y14.5M, 1982.
- CONTROLLING DIMENSION: INCH.
- THE PACKAGE TOP MAY BE SMALLER THAN THE PACKAGE BOTTOM BY UP TO 0.012 (0.300). DIMENSIONS R AND U ARE DETERMINED AT THE OUTERMOST EXTREMES OF THE PLASTIC BODY EXCLUSIVE OF MOLD FLASH, TIE BAR BURRS, GATE BURRS AND INTERLEAD FLASH, BUT INCLUDING ANY MISMATCH BETWEEN THE TOP AND BOTTOM OF THE PLASTIC BODY.
- DIMENSION H DOES NOT INCLUDE DAMBAR PROTRUSION OR INTRUSION. THE DAMBAR PROTRUSION(S) SHALL NOT CAUSE THE H DIMENSION TO BE GREATER THAN 0.037 (0.940). THE DAMBAR INTRUSION(S) SHALL NOT CAUSE THE H DIMENSION TO BE SMALLER THAN 0.025 (0.635).

DIM	INCHES		MILLIMETERS	
	MIN	MAX	MIN	MAX
A	0.685	0.695	17.40	17.65
B	0.685	0.695	17.40	17.65
C	0.165	0.180	4.20	4.57
E	0.090	0.110	2.29	2.79
F	0.013	0.019	0.33	0.48
G	0.050 BSC		1.27 BSC	
H	0.026	0.032	0.66	0.81
J	0.020	---	0.51	---
K	0.025	---	0.64	---
R	0.650	0.656	16.51	16.66
U	0.650	0.656	16.51	16.66
V	0.042	0.048	1.07	1.21
W	0.042	0.048	1.07	1.21
X	0.042	0.056	1.07	1.42
Y	---	0.020	---	0.50
Z	2°	10°	2°	10°
G1	0.610	0.630	15.50	16.00
K1	0.040	---	1.02	---

CS1087

PACKAGE DIMENSIONS

SO-28L
DW SUFFIX
CASE 751F-05
ISSUE G

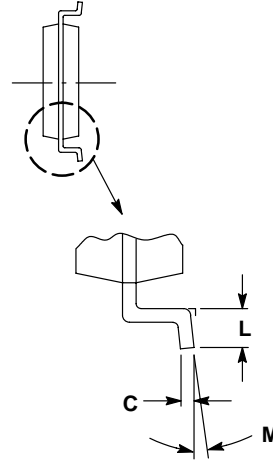
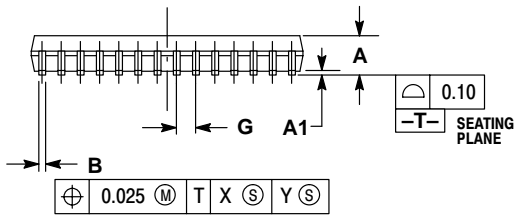
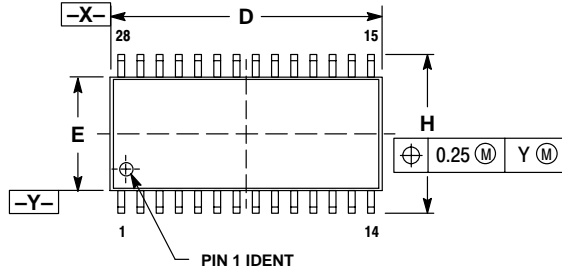

NOTES:

1. DIMENSIONING AND TOLERANCING PER ANSI Y14.5M, 1982.
2. CONTROLLING DIMENSION: MILLIMETER.
3. DIMENSIONS D AND E DO NOT INCLUDE MOLD PROTRUSION
4. MAXIMUM MOLD PROTRUSION 0.15 PER SIDE.
5. DIMENSION B DOES NOT INCLUDE DAMBAR PROTRUSION. ALLOWABLE DAMBAR PROTRUSION SHALL NOT BE 0.13 TOTAL IN EXCESS OF B DIMENSION AT MAXIMUM MATERIAL CONDITION.

DIM	MILLIMETERS	
	MIN	MAX
A	2.35	2.65
A1	0.13	0.29
B	0.35	0.49
C	0.23	0.32
D	17.80	18.05
E	7.40	7.60
G	1.27 BSC	
H	10.05	10.55
L	0.41	0.90
M	0°	8°

Notes

ON Semiconductor and  are trademarks of Semiconductor Components Industries, LLC (SCILLC). SCILLC reserves the right to make changes without further notice to any products herein. SCILLC makes no warranty, representation or guarantee regarding the suitability of its products for any particular purpose, nor does SCILLC assume any liability arising out of the application or use of any product or circuit, and specifically disclaims any and all liability, including without limitation special, consequential or incidental damages. "Typical" parameters which may be provided in SCILLC data sheets and/or specifications can and do vary in different applications and actual performance may vary over time. All operating parameters, including "Typicals" must be validated for each customer application by customer's technical experts. SCILLC does not convey any license under its patent rights nor the rights of others. SCILLC products are not designed, intended, or authorized for use as components in systems intended for surgical implant into the body, or other applications intended to support or sustain life, or for any other application in which the failure of the SCILLC product could create a situation where personal injury or death may occur. Should Buyer purchase or use SCILLC products for any such unintended or unauthorized application, Buyer shall indemnify and hold SCILLC and its officers, employees, subsidiaries, affiliates, and distributors harmless against all claims, costs, damages, and expenses, and reasonable attorney fees arising out of, directly or indirectly, any claim of personal injury or death associated with such unintended or unauthorized use, even if such claim alleges that SCILLC was negligent regarding the design or manufacture of the part. SCILLC is an Equal Opportunity/Affirmative Action Employer.

PUBLICATION ORDERING INFORMATION

Literature Fulfillment:

Literature Distribution Center for ON Semiconductor
P.O. Box 5163, Denver, Colorado 80217 USA
Phone: 303-675-2175 or 800-344-3860 Toll Free USA/Canada
Fax: 303-675-2176 or 800-344-3867 Toll Free USA/Canada
Email: ONlit@hibbertco.com

N. American Technical Support: 800-282-9855 Toll Free USA/Canada

JAPAN: ON Semiconductor, Japan Customer Focus Center
4-32-1 Nishi-Gotanda, Shinagawa-ku, Tokyo, Japan 141-0031
Phone: 81-3-5740-2700
Email: r14525@onsemi.com

ON Semiconductor Website: <http://onsemi.com>

For additional information, please contact your local Sales Representative.