

HALL AMPLIFIER IC

■GENERAL DESCRIPTION

The NJM2650 is a dual hall amplifier IC for converting signals from hall sensors to digital signals.

It is suitable for speed and position sensing of motor control system using DSP or micro controllers.

The NJM2650 can turn off the amplifier block and bias supply of hall device at the standby. Therefore, the consumption current of the application can be reduced.

■PACKAGE OUTLINE

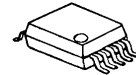

NJM2650V

■FEATURES

- Position Sensing Output
- Chip Enable
- Hall Bias Stand-By Function
- Open Collector Output
- Bipolar Technology
- Package Outline

SSOP10

■PIN CONFIGURATION

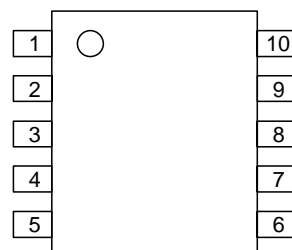

NJM2650V

PIN Function

1. A +INPUT
2. A -INPUT
3. OUT1
4. HBIAS
5. GND
6. STBY
7. OUT2
8. B -INPUT
9. B +INPUT
10. V⁺

NJM2650

■BLOCK DIAGRAM

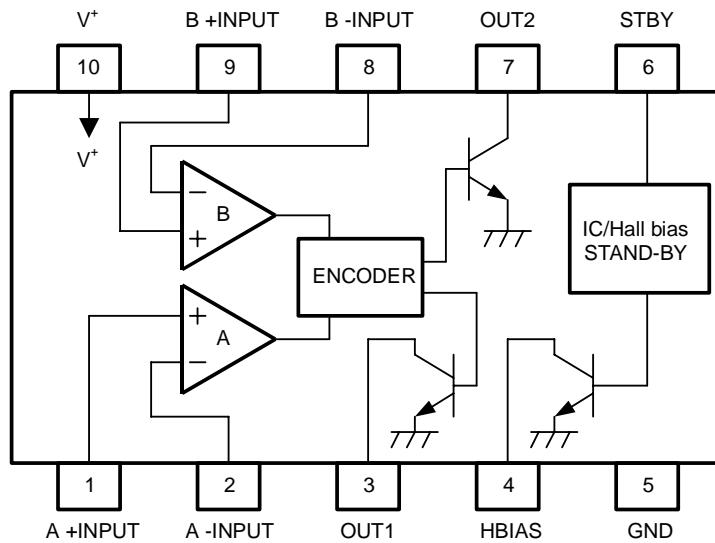

■ABSOLUTE MAXIMUM RATINGS (Ta=25°C)

PARAMETER	SYMBOL	RATINGS	UNIT
Maximum Supply Voltage	V ⁺	20	V
Output Voltage	V _{OUT}	V ⁺	V
Output Current	I _{OUT}	7	mA
Hall Bias Current	I _{OBIAS}	20	mA
Stand-By Terminal	V _{OUT}	V ⁺	V
Differential Input Voltage	V _{ID}	V ⁺	V
Input Voltage	V _{IC}	-0.3 ~ V ⁺ -1.5	V
Power Dissipation	P _D	SSOP10 250	mW
Operating Temperature Range	T _{opr}	-40 ~ +85	°C
Storage Temperature Range	T _{stg}	-50 ~ +150	°C

Output to GND in internal diode for ESD.

Output voltage is below to IC supply voltage.

■ELECTRICAL CHARACTERISTICS (V⁺=5V, V_{STBY}=5V, Ta=25°C)

Total Device

PARAMETER	SYMBOL	TEST CONDITION	MIN.	TYP.	MAX.	UNIT
Supply Voltage	V ⁺		4.5	–	18	V
Supply Current 1	I _{CC1}	R _L =∞	–	2	4	mA
Supply Current 2	I _{CC2}	V _{STBY} =0V	–	30	60	μA

Hall Amplifier Section

PARAMETER	SYMBOL	TEST CONDITION	MIN.	TYP.	MAX.	UNIT
Input Offset Voltage	V _{IO}		-4.2	–	4.2	mV
Input Common Mode Voltage Range	V _{ICM}		1.5	–	3.5	V
Input Bias Current	I _B		–	–	600	nA

Hall Bias Block Section

PARAMETER	SYMBOL	TEST CONDITION	MIN.	TYP.	MAX.	UNIT
Low Level Output Voltage (HBIAS Pin)	V _{OLBIAS}	I _{SINK} =10mA	–	0.1	0.3	V
Output Leak Current (HBIAS Pin)	I _{LEAK(HBIAS)}	V _{OUT} =5V	–	–	5	μA

Output Section

PARAMETER	SYMBOL	TEST CONDITION	MIN.	TYP.	MAX.	UNIT
Low Level Output Voltage (OUT1,OUT2 Pin)	V _{OL1} V _{OL2}	I _{SINK} =5mA	–	0.2	0.5	V
Output Leak Current (OUT1,OUT2 Pin)	I _{LEAK(OUT)}	V _{OUT} =5V	–	–	5	μA

Stand-By Section (Low Level Stand-By)

PARAMETER	SYMBOL	TEST CONDITION	MIN.	TYP.	MAX.	UNIT
Input Low Level Voltage	V _{IL(STBY)}		–	–	0.4	V
Input High Level Voltage	V _{IH(STBY)}		2.4	–	–	V
Input Bias Current	I _{STBY}		–	1	20	μA

NJM2650

TYPICAL APPLICATIONS

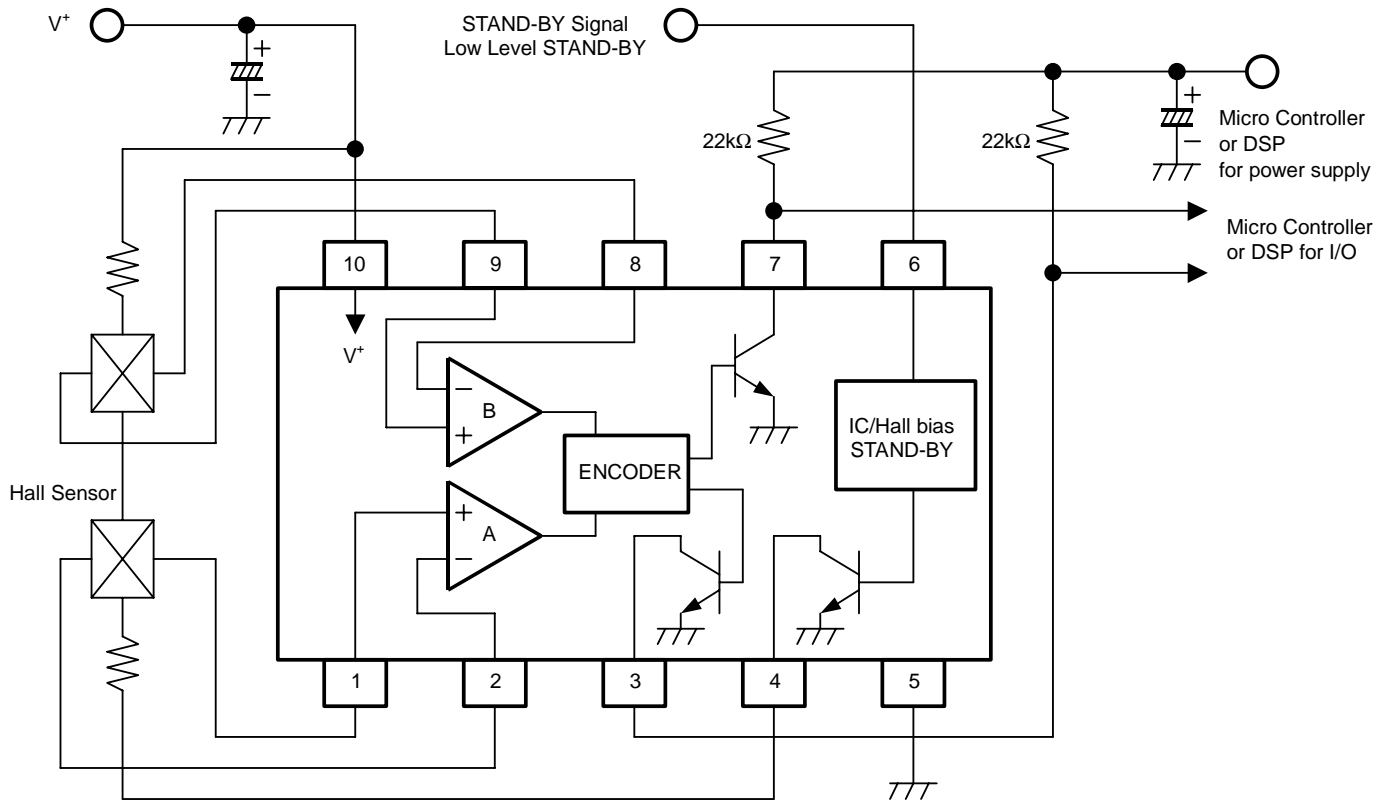

TIMING CHART

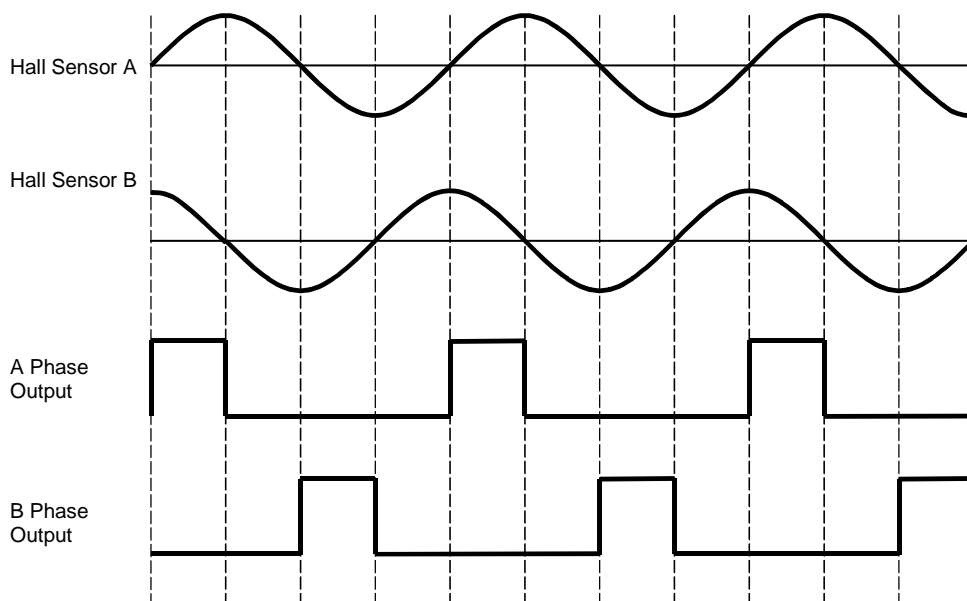

■ TYPICAL CHARACTERISTICS

Low Level Output Voltage vs. Sink Current
(OUT1,OUT2 Pin, $V^+=5V, T_a=25^\circ C$)

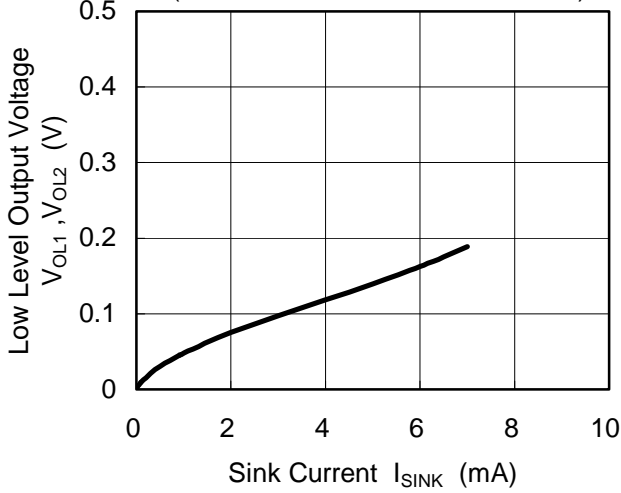

Low Level Output Voltage vs. Sink Current
(HBIAS Pin, $V^+=5V, T_a=25^\circ C$)

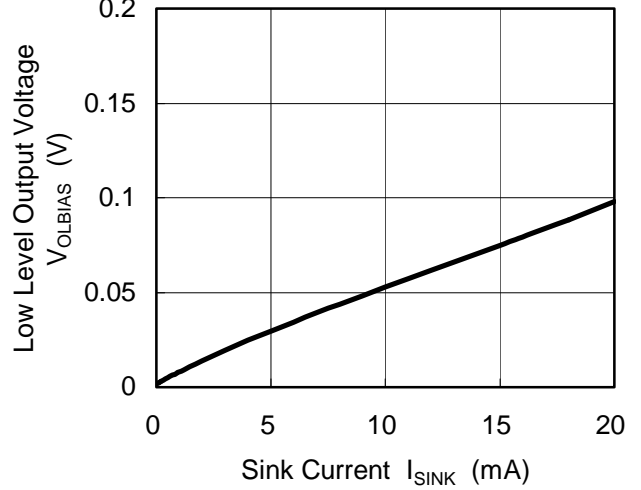

Supply Current 1 vs. Supply Voltage
($R_L=\infty, T_a=25^\circ C$)

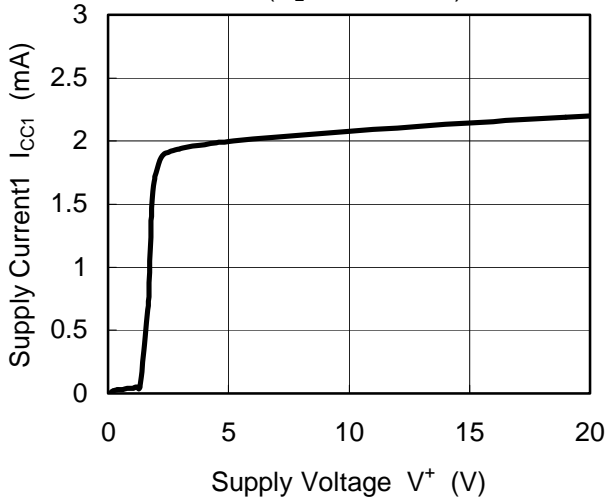

Supply Current 2 vs. Supply Voltage
($V_{STBY}=0V, T_a=25^\circ C$)

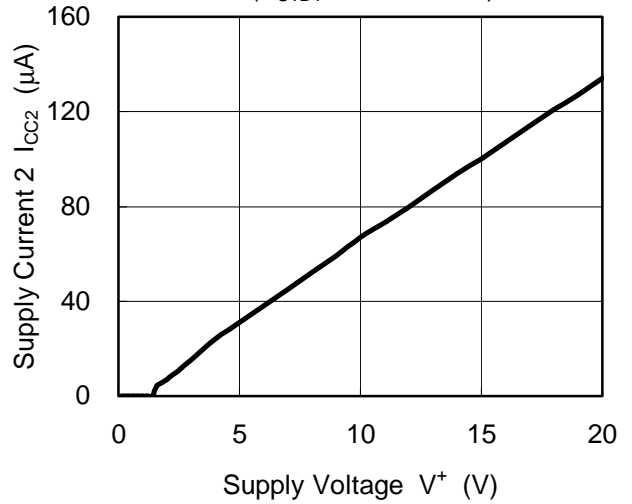

Supply Current vs. Stand-By Input Voltage
($V^+=5V, R_L=\infty, T_a=25^\circ C$)

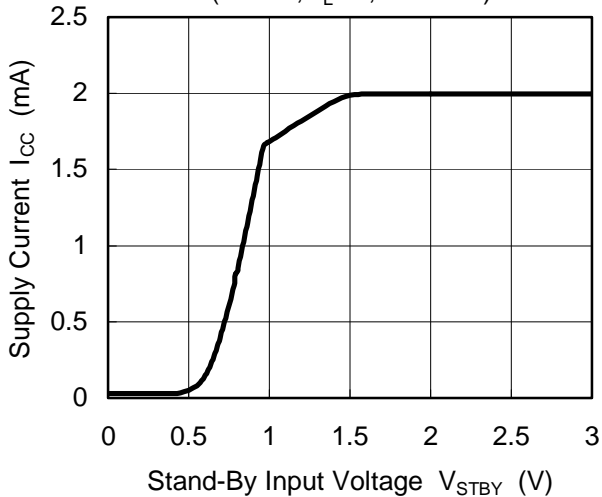

TYPICAL CHARACTERISTICS

Supply Current 1 vs. Temperature
($V^+=5V, R_L=\infty$)

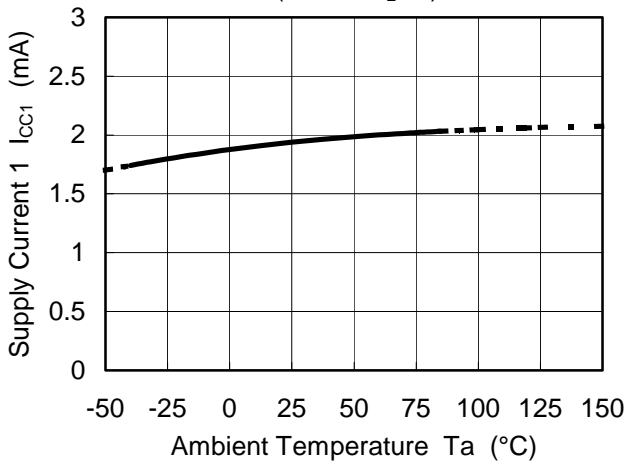

Supply Current 2 vs. Temperature
($V^+=5V, V_{STBY}=0V$)

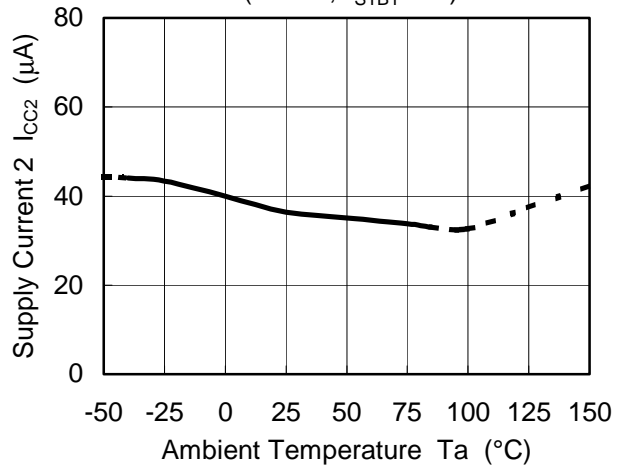

Low Level Output Voltage vs. Temperature
(OUT1, OUT2 Pin, $V^+=5V$)

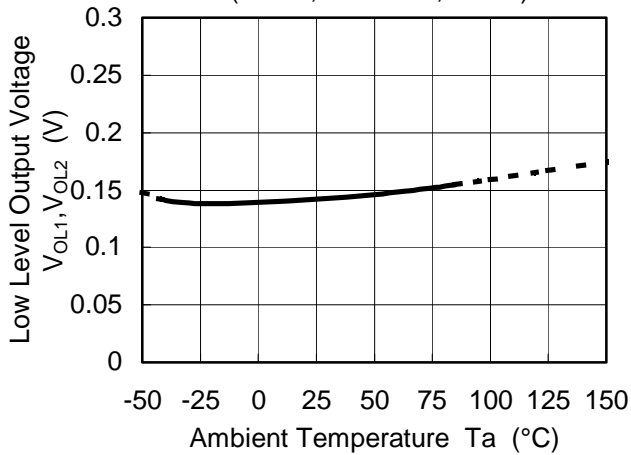

Low Level Output Voltage vs. Temperature
(HBIAS Pin, $V^+=5V$)

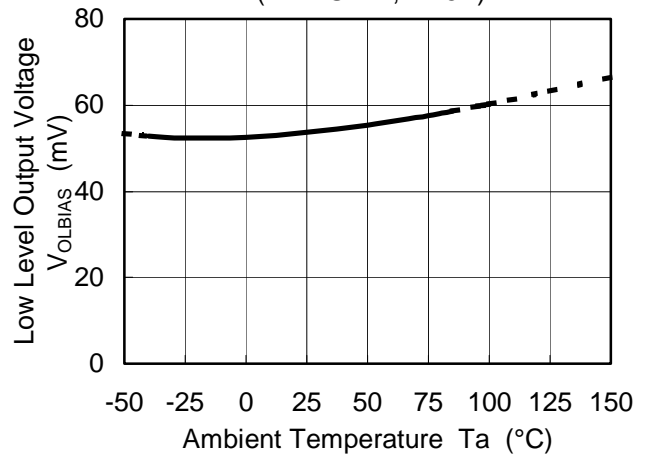

[CAUTION]

The specifications on this databook are only given for information, without any guarantee as regards either mistakes or omissions. The application circuits in this databook are described only to show representative usages of the product and not intended for the guarantee or permission of any right including the industrial rights.