

HEXFET® Power MOSFET

- Advanced Process Technology
- Ultra Low On-Resistance
- Isolated Package
- High Voltage Isolation = 2.5KVRMS^⑤
- Sink to Lead Creepage Dist. = 4.8mm
- Repetitive Avalanche Rated
- 175°C Operating Temperature

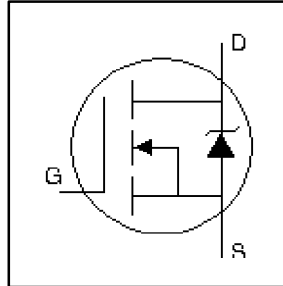

$$V_{DSS} = 100V$$

$$R_{DS(on)} = 0.04\Omega$$

$$I_D = 22A$$

Description

Fourth Generation HEXFETs from International Rectifier utilize advanced processing techniques to achieve the lowest possible on-resistance per silicon area. This benefit, combined with the fast switching speed and ruggedized device design that HEXFET Power MOSFETs are well known for, provides the designer with an extremely efficient device for use in a wide variety of applications.

The TO-220 Fullpak eliminates the need for additional insulating hardware in commercial-industrial applications. The moulding compound used provides a high isolation capability and a low thermal resistance between the tab and external heatsink. This isolation is equivalent to using a 100 micron mica barrier with standard TO-220 product. The Fullpak is mounted to a heatsink using a single clip or by a single screw fixing.

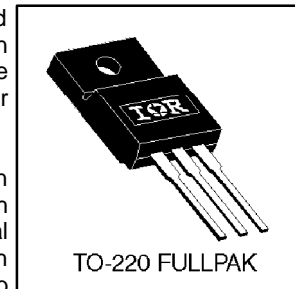

Absolute Maximum Ratings

	Parameter	Max.	Units
$I_D @ T_C = 25^\circ C$	Continuous Drain Current, $V_{GS} @ 10V$	22	
$I_D @ T_C = 100^\circ C$	Continuous Collector Current, $V_{GS} @ 10V$	15	A
I_{DM}	Pulsed Drain Current ^①	88	
$P_D @ T_C = 25^\circ C$	Power Dissipation	48	W
	Linear Derating Factor	0.32	W/°C
V_{GS}	Gate-to-Source Voltage	±20	V
E_{AS}	Single Pulse Avalanche Energy ^②	120	mJ
I_{AR}	Avalanche Current ^③	22	A
E_{AR}	Repetitive Avalanche Energy ^④	4.8	mJ
dv/dt	Peak Diode Recovery dv/dt ^⑤	5.5	V/ns
T_J	Operating Junction and	-55 to + 175	
T_{STG}	Storage Temperature Range		°C
	Soldering Temperature, for 10 seconds	300 (1.6mm from case)	
	Mounting torque, 6-32 or M3 screw.	10 lbf•in (1.1N•m)	

Thermal Resistance

	Parameter	Min.	Typ.	Max.	Units
$R_{\theta JC}$	Junction-to-Case	—	—	3.1	°C/W
$R_{\theta JA}$	Junction-to-Ambient	—	—	—	65

IRFI1310G



Electrical Characteristics @ $T_J = 25^\circ\text{C}$ (unless otherwise specified)

	Parameter	Min.	Typ.	Max.	Units	Conditions
$V_{(BR)DSS}$	Drain-to-Source Breakdown Voltage	100	—	—	V	$V_{GS} = 0V, I_D = 250\mu A$
$\Delta V_{(BR)DSS}/\Delta T_J$	Breakdown Voltage Temp. Coefficient	—	0.10	—	V/°C	Reference to $25^\circ\text{C}, I_D = 1\text{mA}$
$R_{DS(ON)}$	Static Drain-to-Source On-Resistance	—	—	0.04	Ω	$V_{GS} = 10V, I_D = 13A$ ④
$V_{GS(th)}$	Gate Threshold Voltage	2.0	—	4.0	V	$V_{DS} = V_{GS}, I_D = 250\mu A$
g_{fs}	Forward Transconductance	12	—	—	S	$V_{DS} = 50V, I_D = 25A$
I_{DSS}	Drain-to-Source Leakage Current	—	—	25	μA	$V_{DS} = 100V, V_{GS} = 0V$
		—	—	250		$V_{DS} = 80V, V_{GS} = 0V, T_J = 150^\circ\text{C}$
I_{GSS}	Gate-to-Source Forward Leakage	—	—	100	nA	$V_{GS} = 20V$
	Gate-to-Source Reverse Leakage	—	—	-100		$V_{GS} = -20V$
Q_g	Total Gate Charge	—	—	110	nC	$I_D = 25A$
Q_{gs}	Gate-to-Source Charge	—	—	18		$V_{DS} = 80V$
Q_{gd}	Gate-to-Drain ("Miller") Charge	—	—	42		$V_{GS} = 10V$, See Fig. 6 and 13 ④
$t_{d(on)}$	Turn-On Delay Time	—	13	—		ns
t_r	Rise Time	—	77	—	$I_D = 25A$	
$t_{d(off)}$	Turn-Off Delay Time	—	82	—	$R_G = 9.1\Omega$	
t_f	Fall Time	—	64	—	$R_D = 2.0\Omega$, See Fig. 10 ④	
L_D	Internal Drain Inductance	—	4.5	—	nH	Between lead, 6mm (0.25in.) from package and center of die contact
L_S	Internal Source Inductance	—	7.5	—		
C_{iss}	Input Capacitance	—	2500	—	pF	$V_{GS} = 0V$
C_{oss}	Output Capacitance	—	630	—		$V_{DS} = 25V$
C_{rss}	Reverse Transfer Capacitance	—	130	—		$f = 1.0\text{MHz}$, See Fig. 5

Source-Drain Ratings and Characteristics

	Parameter	Min.	Typ.	Max.	Units	Conditions
I_S	Continuous Source Current (Body Diode)	—	—	22	A	MOSFET symbol showing the integral reverse p-n junction diode.
I_{SM}	Pulsed Source Current (Body Diode) ①	—	—	88		
V_{SD}	Diode Forward Voltage	—	—	2.5	V	$T_J = 25^\circ\text{C}, I_S = 13A, V_{GS} = 0V$ ④
t_{rr}	Reverse Recovery Time	—	140	210	ns	$T_J = 25^\circ\text{C}, I_F = 25A$
Q_{rr}	Reverse Recovery Charge	—	0.79	1.2	μC	$di/dt = 100A/\mu s$ ④
t_{on}	Forward Turn-On Time	Intrinsic turn-on time is negligible (turn-on is dominated by L_S+L_D)				

Notes:

① Repetitive rating; pulse width limited by max. junction temperature. (See fig. 11)

③ $I_{SD} \leq 25A, di/dt \leq 170A/\mu s, V_{DD} \leq V_{(BR)DSS}, T_J \leq 175^\circ\text{C}$

⑤ $t=60s, f=60\text{Hz}$

② $V_{DD} = 25V, \text{ starting } T_J = 25^\circ\text{C}, L = 1.0\text{mH}$
 $R_G = 25\Omega, I_{AS} = 13A.$ (See Figure 12)

④ Pulse width $\leq 300\mu s$; duty cycle $\leq 2\%$.

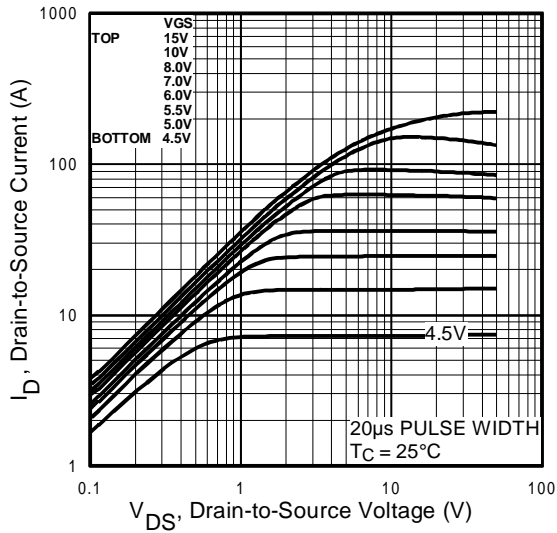

Fig 1. Typical Output Characteristics, $T_C = 25^\circ\text{C}$

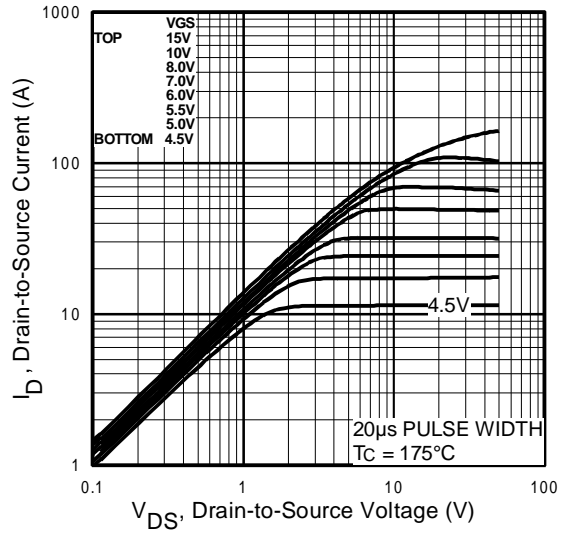

Fig 2. Typical Output Characteristics, $T_C = 175^\circ\text{C}$

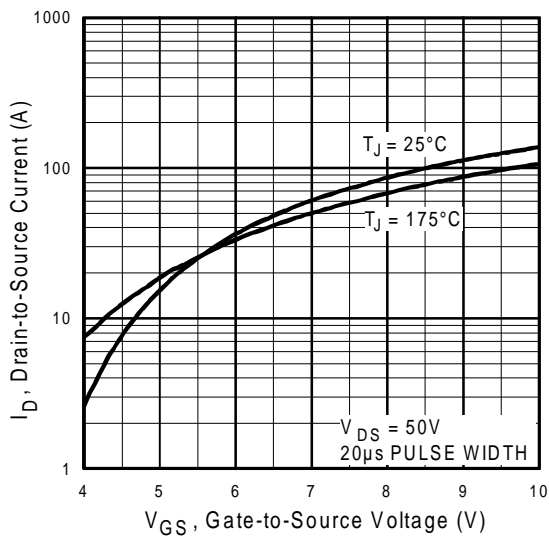

Fig 3. Typical Transfer Characteristics

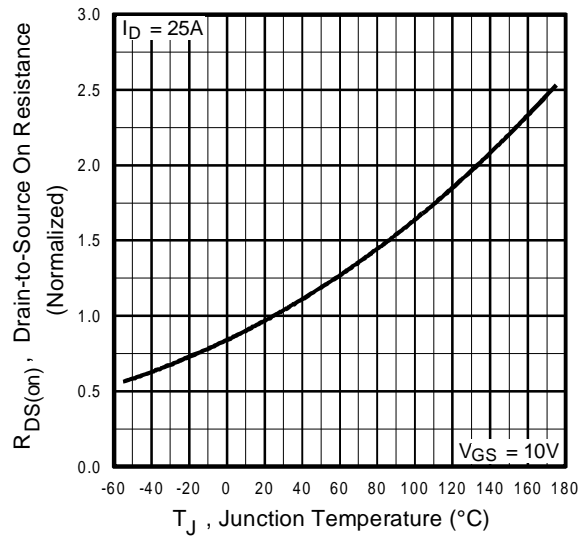

Fig 4. Normalized On-Resistance Vs. Temperature

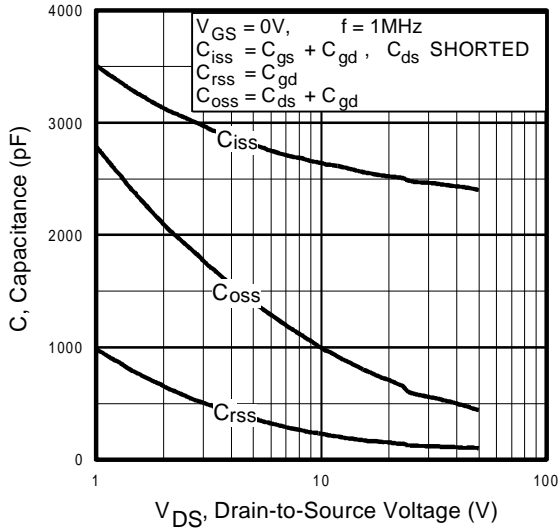

Fig 5. Typical Capacitance Vs. Drain-to-Source Voltage

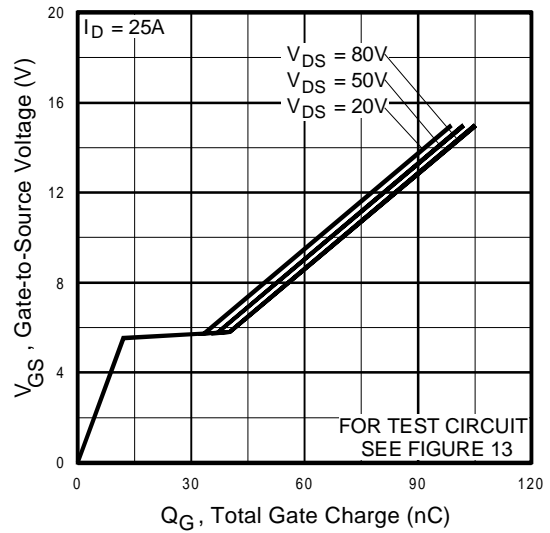

Fig 6. Typical Gate Charge Vs. Gate-to-Source Voltage

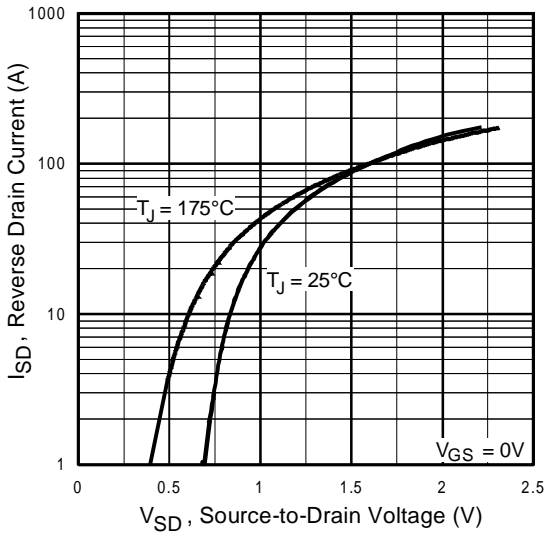

Fig 7. Typical Source-Drain Diode Forward Voltage

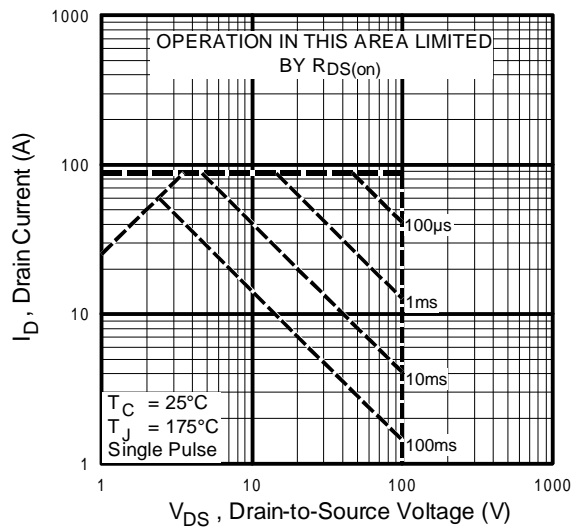

Fig 8. Maximum Safe Operating Area

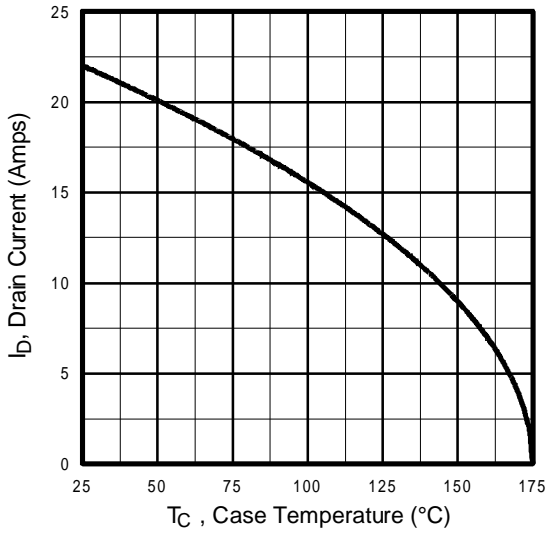

Fig 9. Maximum Drain Current Vs. Case Temperature

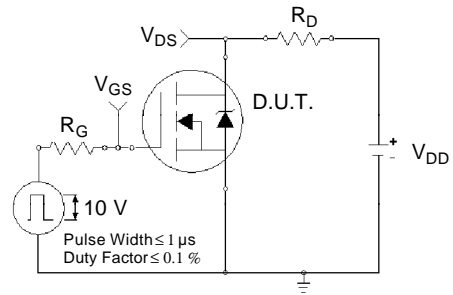

Fig 10a. Switching Time Test Circuit



Fig 10b. Switching Time Waveforms

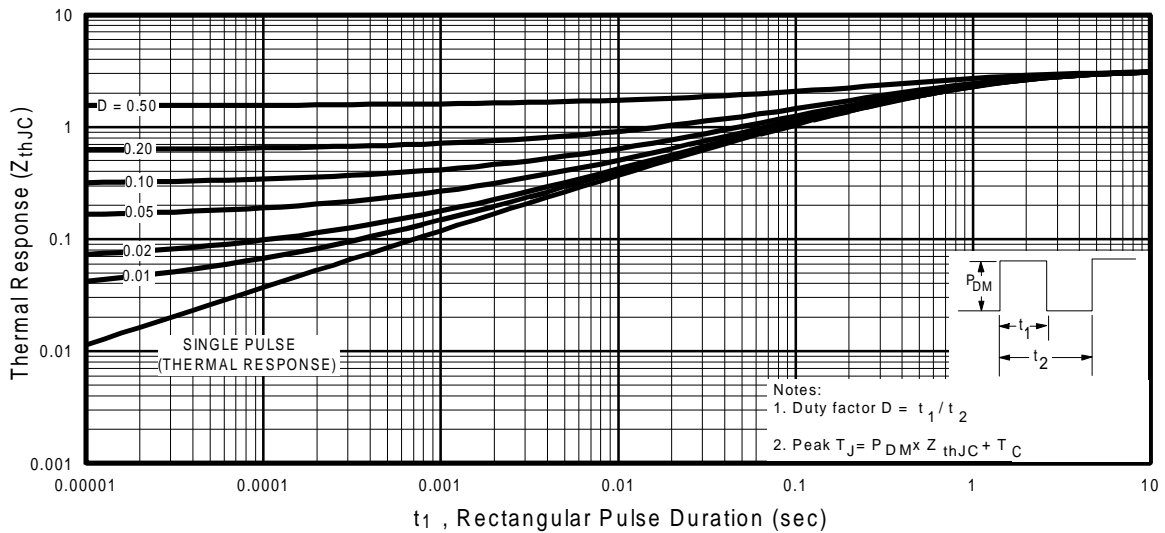

Fig 11. Maximum Effective Transient Thermal Impedance, Junction-to-Case

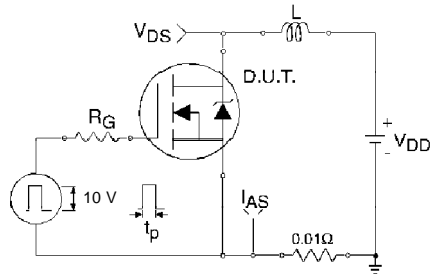

Fig 12a. Unclamped Inductive Test Circuit



Fig 12b. Unclamped Inductive Waveforms

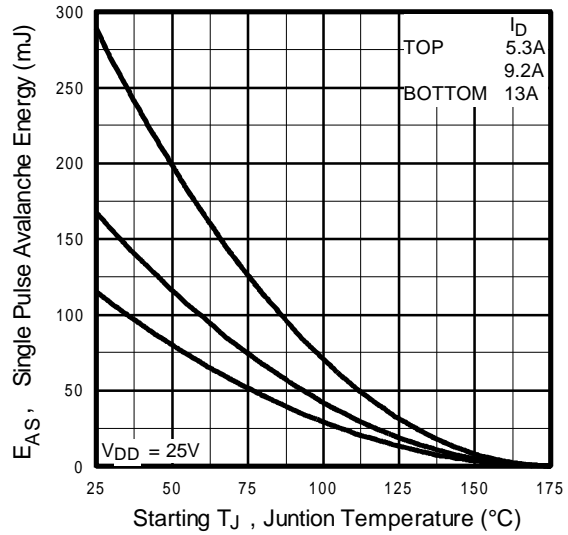

Fig 12c. Maximum Avalanche Energy Vs. Drain Current

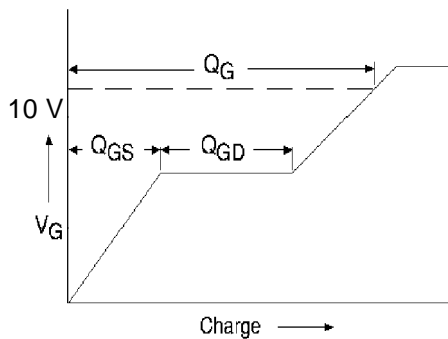

Fig 13a. Basic Gate Charge Waveform

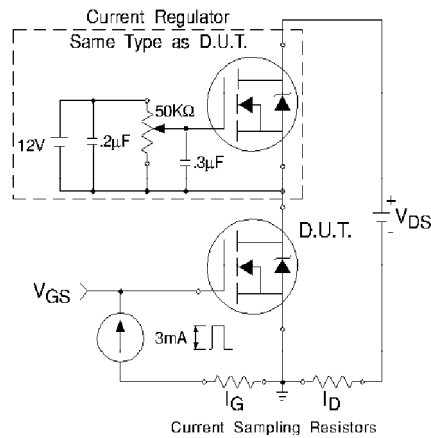

Fig 13b. Gate Charge Test Circuit

Appendix A: Figure 14, Peak Diode Recovery dv/dt Test Circuit

Appendix B: Package Outline Mechanical Drawing

Appendix C: Part Marking Information

Peak Diode Recovery dv/dt Test Circuit

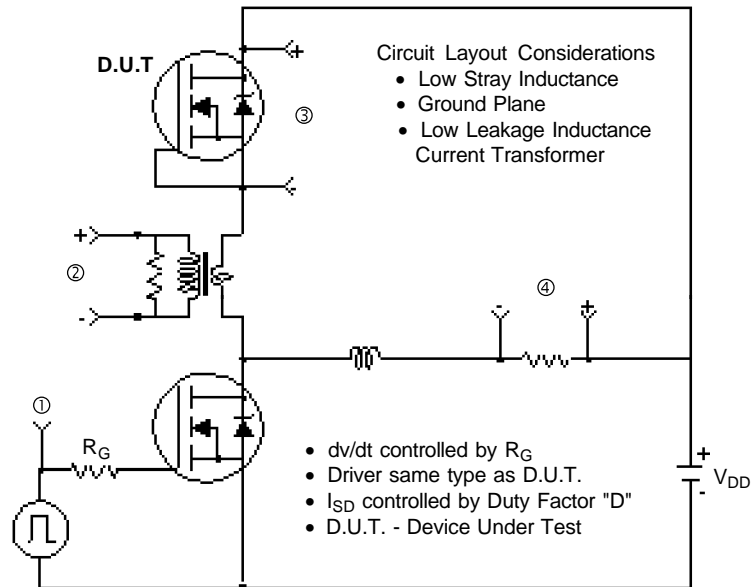

* $V_{GS} = 5V$ for Logic Level Devices

Fig 14. For N-Channel HEXFETS

IRFI1310G



Package Outline

TO-220 Full-Pak

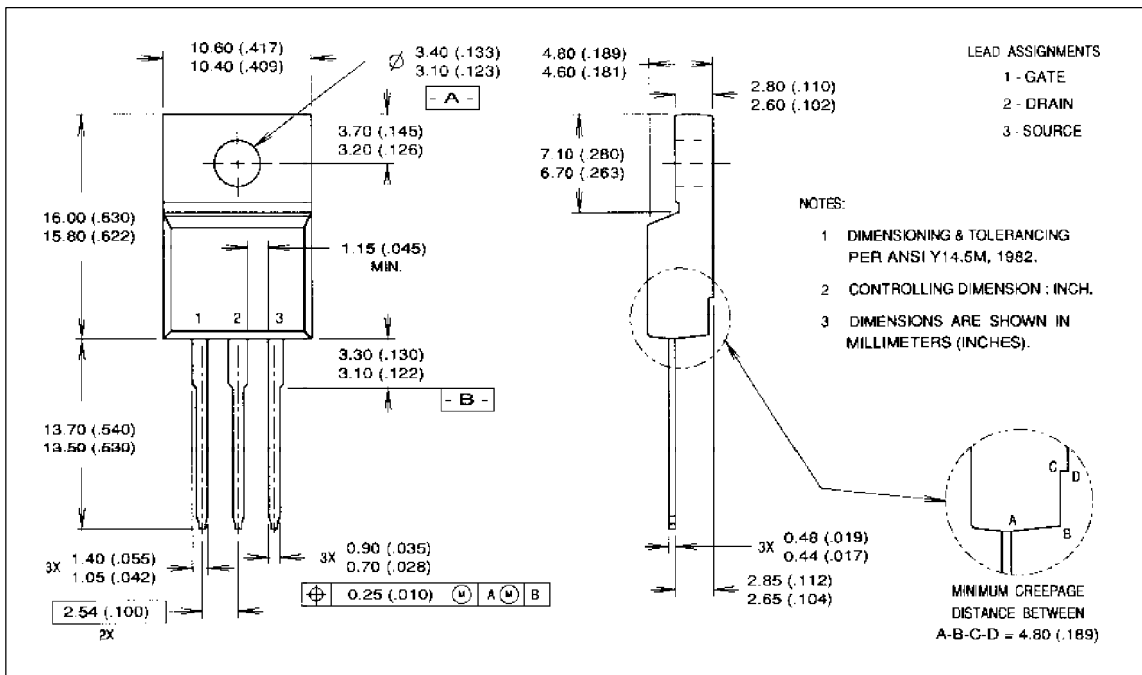

Part Marking Information

TO-220 Full-Pak

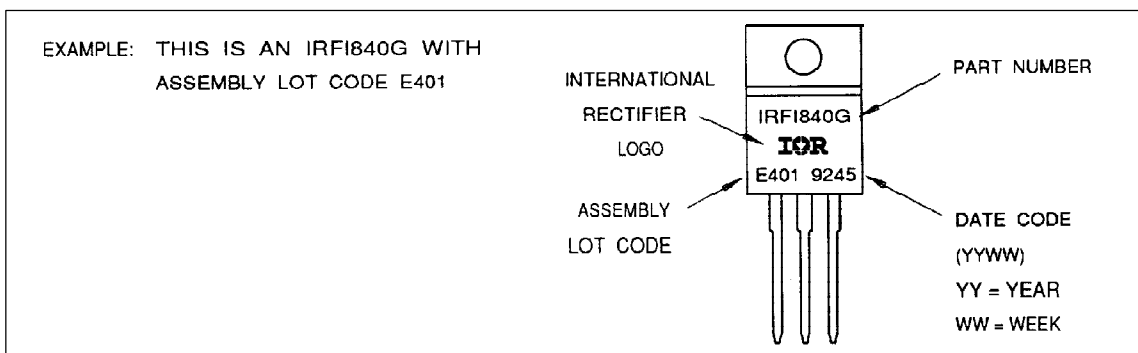

WORLD HEADQUARTERS: 233 Kansas St., El Segundo, California 90245, Tel: (310) 322 3331
EUROPEAN HEADQUARTERS: Hurst Green, Oxted, Surrey RH8 9BB, UK Tel: (44) 0883 713215
IR CANADA: 7321 Victoria Park Ave., Suite 201, Markham, Ontario L3R 3L1, Tel: (905) 475 1897 **IR GERMANY:** Saalburgstrasse 157, 61350 Bad Homburg Tel: 6172 37066 **IR ITALY:** Via Liguria 49, 10071 Borgaro, Torino Tel: (39) 1145 10111 **IR FAR EAST:** K&H Bldg., 2F, 3-30-4 Nishi-Ikeburo 3-Chome, Toshima-Ki, Tokyo 171 Tel: (03)3983 0641 **IR SOUTHEAST ASIA:** 315 Outram Road, #10-02 Tan Boon Liat Building, 0316 Tel: 65 221 8371

Data and specifications subject to change without notice.