

DIODE MODULE (NON-ISOLATED TYPE)

DKR200AB60

DKR200AB60 is a high speed (fast recovery) dual diode module designed for high power switching application. DKR200AB60 is suitable for high frequency application requiring low loss and high speed control.

- High Speed Diode $t_{rr} \leq 200\text{ns}$
- $I_{F(AV)} = 100\text{A}$ (each device)
- High Surge Capability

(Applications)

Switching Power Supply, Inverter Welding Power Supply
Power Supply for Telecommunication

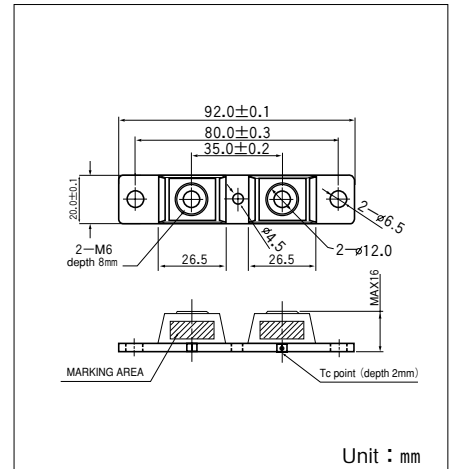
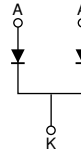

Unit : mm

Maximum Ratings

($T_j = 25^\circ\text{C}$ unless otherwise specified)

Symbol	Item	Ratings		Unit
		DKR200AB60		
V_{RRM}	Repetitive peak reverse Voltage	600		V
$V_{R(DC)}$	D.C. Reverse Voltage	480		V

Symbol	Item		Condition	Ratings	Unit
I_F	Forward Current	Per module	D.C. $T_c = 133^\circ\text{C}$	200	A
		Per leg		100	
I_{FSM}	Surge Forward Current		$\frac{1}{2}$ cycle, 60Hz, Peak value. non-repetitive	3600	A
			$\frac{1}{2}$ cycle, 50Hz, Peak value. non-repetitive	3200	
I^2t	I^2t (for fusing)		Value for one cycle surge current	54000	A^2S
T_j	Operating Junction Temperature			-40 to $+150$	$^\circ\text{C}$
T_{stg}	Storage Temperature			-40 to $+125$	$^\circ\text{C}$
	Mounting Torque	Mounting (M6)	Recommended Value 25-40	48	$(\text{kgf} \cdot \text{cm})$
			Recommended Value 2.5-3.9	4.7	$\text{N} \cdot \text{m}$
		Mounting (M4)	Recommended Value 10-14	15	$(\text{kgf} \cdot \text{cm})$
			Recommended Value 1.0-1.4	1.5	$\text{N} \cdot \text{m}$
		Terminal (M6)	Recommended Value 25-40	48	$(\text{kgf} \cdot \text{cm})$
			Recommended Value 2.5-3.9	4.7	$\text{N} \cdot \text{m}$
	Mass	Typical Value		80	g

Electrical Characteristics

Symbol	Item	Condition	Ratings			Unit
			Min.	Typ.	Max.	
I_{RRM}	Repetitive Peak Reverse Current	$T_j = 125^\circ\text{C}$, $V_D = V_{RRM}$			200	mA
V_{FM}	Forward Voltage Drop	$I_F = 200\text{A}$, Inst.measurement			1.4	V
t_{rr}	Reverse Recovery Time	$I_F = 200\text{A}$, $-di/dt = 200\text{A}/\mu\text{s}$		100	200	ns
$R_{th(j-c)}$	Thermal Impedance	Junction to case, $\frac{1}{2}$ module			0.063	$^\circ\text{C}/\text{W}$

