

PLASTIC MEDIUM-POWER COMPLEMENTARY SILICON TRANSISTORS

...designed for general-purpose amplifier and low speed switching applications

FEATURES:

- * Collector-Emitter Sustaining Voltage-
 $V_{CE(SUS)}$ = 60 V (Min) - TIP100, TIP105
 = 80 V (Min) - TIP101, TIP106
 = 100 V (Min) - TIP102, TIP107
- * Collector-Emitter Saturation Voltage
 $V_{CE(sat)}$ = 2.0 V (Max.) @ $I_C = 3.0$ A
- * Monolithic Construction with Built-in Base-Emitter Shunt Resistor

NPN	PNP
TIP100	TIP105
TIP101	TIP106
TIP102	TIP107

**8 AMPERE
DARLINGTON
COMPLEMENTARY SILICON
POWER TRANSISTORS
60-100 VOLTS
80 WATTS**

MAXIMUM RATINGS

Characteristic	Symbol	TIP100 TIP105	TIP101 TIP106	TIP102 TIP107	Unit
Collector-Emitter Voltage	V_{CEO}	60	80	100	V
Collector-Base Voltage	V_{CBO}	60	80	100	V
Emitter-Base Voltage	V_{EBO}	5.0			V
Collector Current-Continuous	I_C	8.0			A
-Peak	I_{CM}	15			
Base Current	I_B	1.0			A
Total Power Dissipation @ $T_C = 25^\circ\text{C}$ Derate above 25°C	P_D	80 0.64			W W/ $^\circ\text{C}$
Operating and Storage Junction Temperature Range	T_J, T_{STG}	- 65 to +150			$^\circ\text{C}$

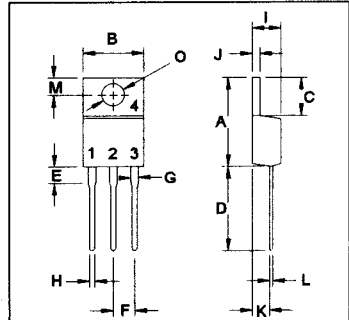
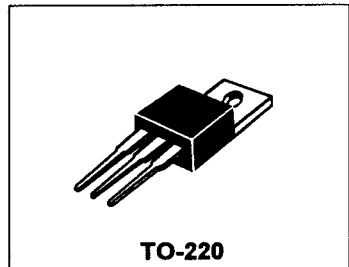

PIN 1.BASE
2.COLLECTOR
3.EMITTER
4.COLLECTOR(CASE)

THERMAL CHARACTERISTICS

Characteristic	Symbol	Max	Unit
Thermal Resistance Junction to Case	$R_{\theta jc}$	1.56	$^\circ\text{C/W}$

DIM	MILLIMETERS	
	MIN	MAX
A	14.68	15.31
B	9.78	10.42
C	5.01	6.52
D	13.06	14.62
E	3.57	4.07
F	2.42	3.66
G	1.12	1.36
H	0.72	0.96
I	4.22	4.98
J	1.14	1.38
K	2.20	2.97
L	0.33	0.55
M	2.48	2.98
O	3.70	3.90

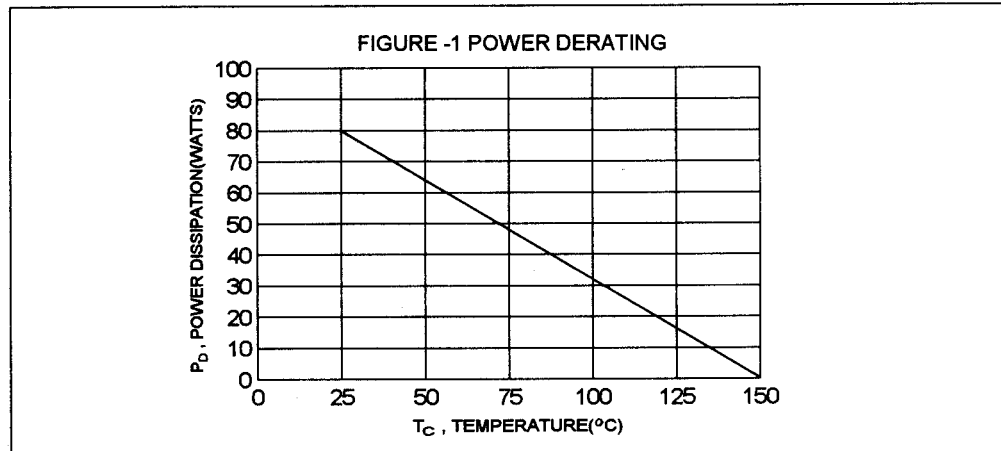

TIP100, TIP101, TIP102 NPN / TIP105, TIP106, TIP107 PNP

ELECTRICAL CHARACTERISTICS ($T_C = 25^\circ\text{C}$ unless otherwise noted)

Characteristic	Symbol	Min	Max	Unit
----------------	--------	-----	-----	------

OFF CHARACTERISTICS

Collector - Emitter Sustaining Voltage (1) ($I_C = 30\text{ mA}, I_B = 0$) TIP100, TIP105 TIP101, TIP106 TIP102, TIP107	$V_{CE(sus)}$	60 80 100		V
Collector Cutoff Current ($V_{CE} = 30\text{ V}, I_B = 0$) ($V_{CE} = 40\text{ V}, I_B = 0$) ($V_{CE} = 50\text{ V}, I_B = 0$) TIP100, TIP105 TIP101, TIP106 TIP102, TIP107	I_{CEO}		50 50 50	μA
Collector Cutoff Current ($V_{CB} = 60\text{ V}, I_E = 0$) ($V_{CB} = 80\text{ V}, I_E = 0$) ($V_{CB} = 100\text{ V}, I_E = 0$) TIP100, TIP105 TIP101, TIP106 TIP102, TIP107	I_{CBO}		50 50 50	μA
Emitter Cutoff Current ($V_{EB} = 5.0\text{ V}, I_C = 0$)	I_{EBO}		8.0	mA

ON CHARACTERISTICS (1)

DC Current Gain ($I_C = 3.0\text{ A}, V_{CE} = 4.0\text{ V}$) ($I_C = 8.0\text{ A}, V_{CE} = 4.0\text{ V}$)	h_{FE}	1000 200	20000	
Collector-Emitter Saturation Voltage ($I_C = 3.0\text{ A}, I_B = 6.0\text{ mA}$) ($I_C = 8.0\text{ A}, I_B = 80\text{ mA}$)	$V_{CE(sat)}$		2.0 2.5	V
Base-Emitter On Voltage ($I_C = 8.0\text{ A}, V_{CE} = 4.0\text{ V}$)	$V_{BE(on)}$		2.8	V

DYNAMIC CHARACTERISTICS

Small-Signal Current Gain ($I_C = 3.0\text{ A}, V_{CE} = 4.0\text{ V}, f = 1.0\text{ MHz}$)	h_{fe}	4.0		
Output Capacitance ($V_{CB} = 10\text{ V}, I_E = 0, f = 0.1\text{ MHz}$) TIP100, TIP101, TIP102 TIP105, TIP106, TIP107	C_{ob}		300 250	pF

(1) Pulse Test: Pulse width = 300 μs , Duty Cycle $\leq 2.0\%$

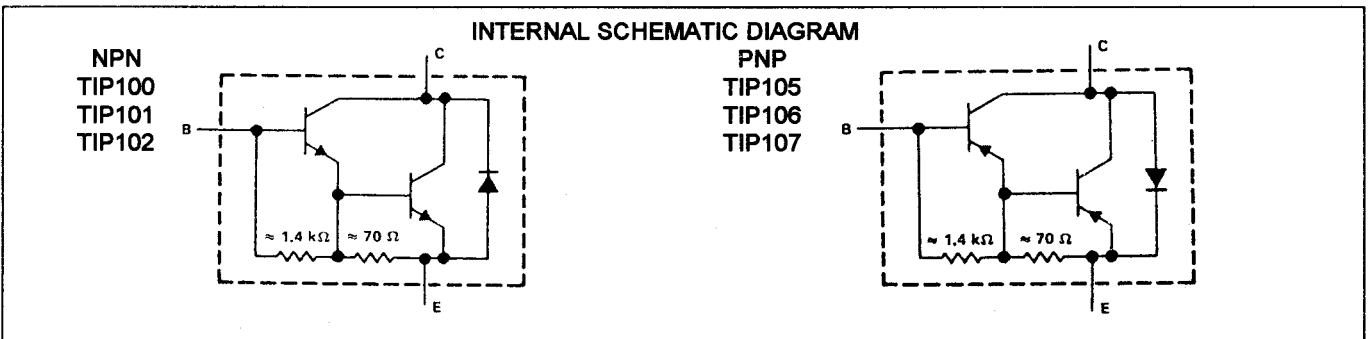

FIG-2 SWITCHING TIME

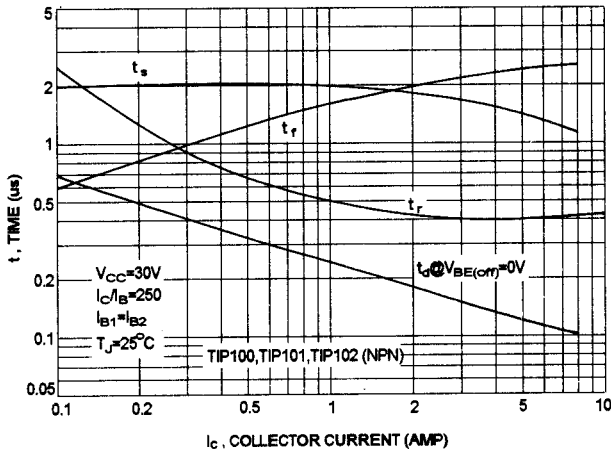

FIG-3 SWITCHING TIME

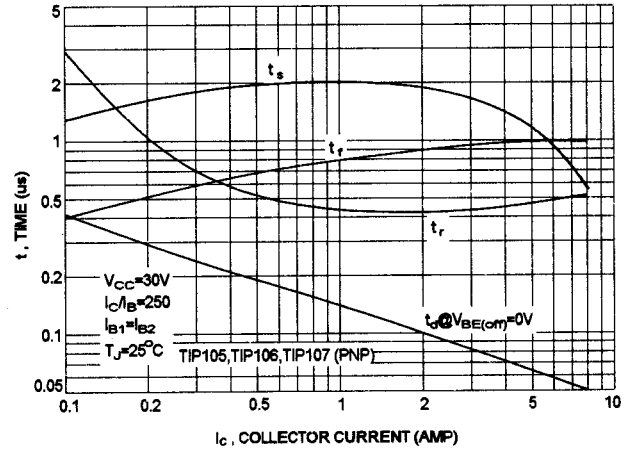

FIG-4 SMALL-SIGNAL CURRENT GAIN

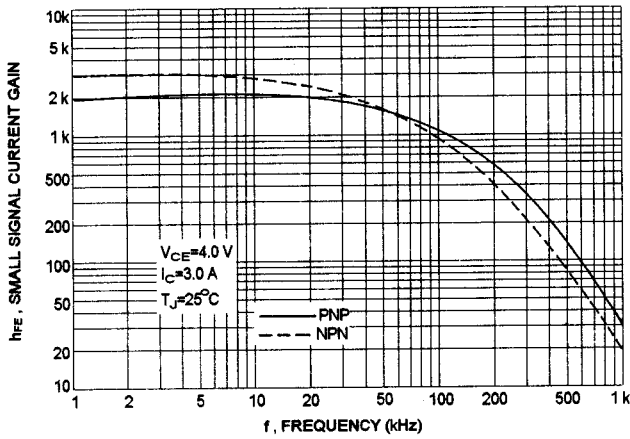

FIG-5 CAPACITANCES

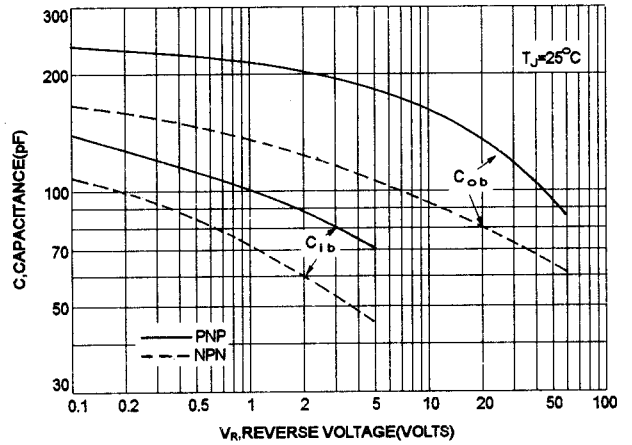
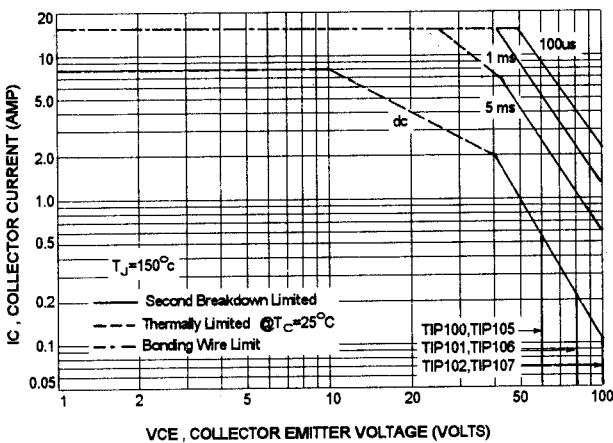

FIG-6 ACTIVE REGION SAFE OPERATING AREA



There are two limitation on the power handling ability of a transistor: average junction temperature and second breakdown safe operating area curves indicate I_c-V_{CE} limits of the transistor that must be observed for reliable operation i.e., the transistor must not be subjected to greater dissipation than curves indicate.

The data of FIG-6 is base on T_{J(PK)}≈150°C; T_C is variable depending on power level. second breakdown pulse limits are valid for duty cycles to 10% provided T_{J(PK)}≤150°C. At high case temperatures, thermal limitation will reduce the power that can be handled to values less than the limitations imposed by second breakdown.

TIP100, TIP101, TIP102 NPN / TIP105, TIP106 TIP107 PNP

NPN TIP100, TIP101, TIP102

PNP TIP105, TIP106, TIP107

FIG-7 DC CURRENT GAIN

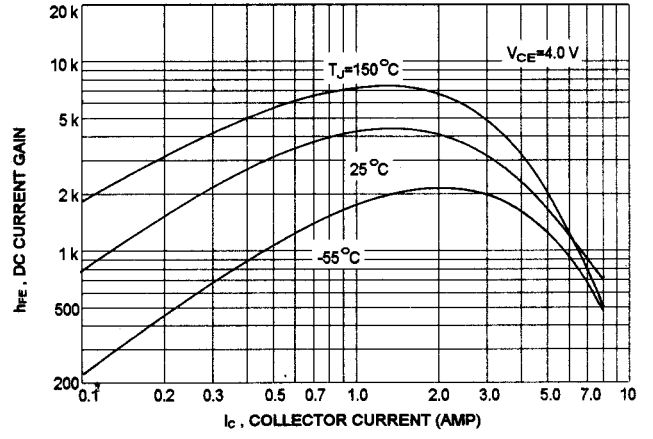
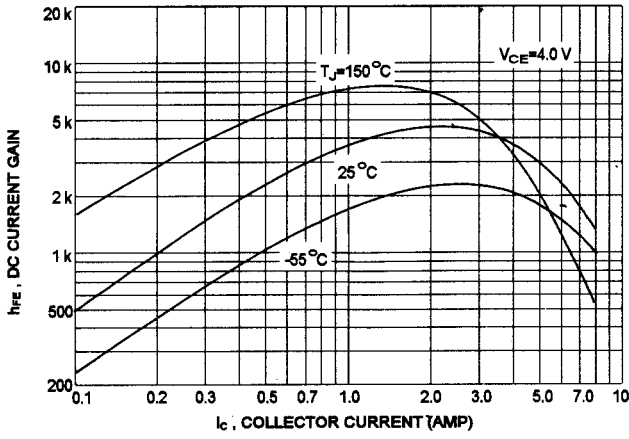

FIG-8 COLLECTOR SATURATION REGION

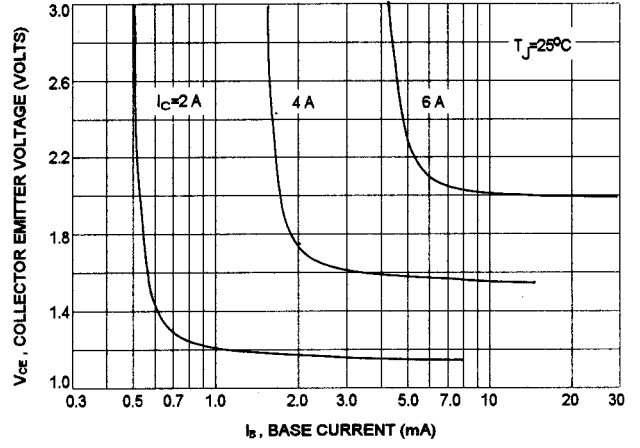
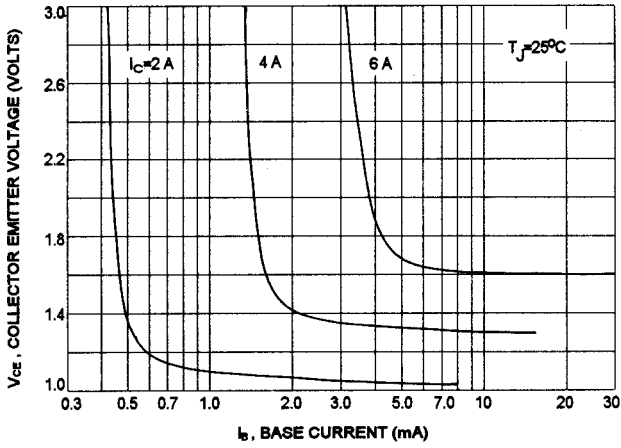

FIG-9 "ON" VOLTAGES

