

FEATURES

- * Dual MOS FETs Cascaded Circuit
- * Prevented Body Diodes of MOSFETs by SBDs, and Ultra Fast Recovery Diodes Connected in Parallel
- * 300KHz High Speed Switching Possible

TYPICAL APPLICATIONS

- * Power Supply for the Communications and the Induction Heating

OUTLINE DRAWING

Dimension(mm)

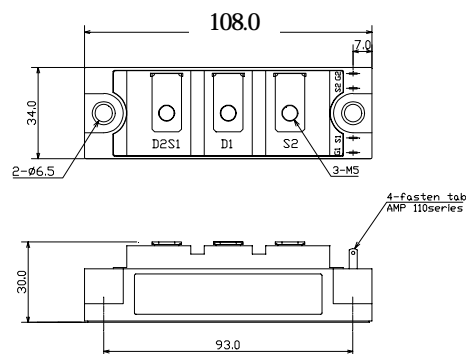
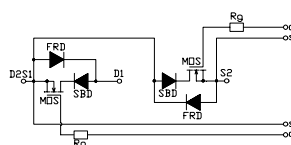
Circuit

Approximate Weight : 220g

MAXMUM RATINGS

Ratings		Symbol	PD10M441H	PD10M440H	Unit
Drain-Source Voltage ($V_{GS}=0V$)		V_{DSS}	450	500	V
Gate - Source Voltage		V_{GSS}	+/- 20		V
Continuous Drain Current	Duty=50%	I_D	85 ($T_c=25^\circ C$)		A
	D.C.		60 ($T_c=25^\circ C$)		
Pulsed Drain Current		I_{DM}	170 ($T_c=25^\circ C$)		A
Total Power Dissipation		P_D	730 ($T_c=25^\circ C$)		W
Operating Junction Temperature Range		T_{jw}	-40 to +150		$^\circ C$
Storage Temperature Range		T_{sg}	-40 to +125		$^\circ C$
Isolation Voltage (Terminals to Base AC, 1 min.)		V_{ISO}	2000		V
Mounting Torque	Module Base to Heatsink	F_{TOR}	3.0		N•m
	Bus Bar to Main Terminals		2.0		

ELECTRICAL CHARACTERISTICS (@ $T_c=25^\circ C$ unless otherwise noted)

Characteristic	Symbol	Test Condition	Min.	Typ.	Max.	Unit
Zero Gate Voltage Drain Current	I_{DSS}	$V_{DS}=V_{DSS}, V_{GS}=0V$	-	-	1.0	mA
		$T_j=125^\circ C, V_{DS}=V_{DSS}, V_{GS}=0V$	-	-	4.0	
Gate-Source Threshold Voltage	$V_{GS(th)}$	$V_{DS}=V_{GS}, I_D=1mA$	2.0	3.1	4.0	V
Gate-Source Leakage Current	I_{GSS}	$V_{GS}=\pm 20V, V_{DS}=0V$	-	-	1.0	μA
Static Drain-Source On-Resistance	$r_{DS(on)}$	$V_{GS}=10V, I_D=40A$	-	75	85	m-ohm
Drain-Source On-Voltage	$V_{DS(on)}$	$V_{GS}=10V, I_D=40A$	-	3.5	3.9	V
Forward Transconductance	g_{fs}	$V_{DS}=15V, I_D=40A$	-	65	-	S
Input Capacitance	C_{ies}	$V_{DS}=25V, V_{GS}=0V, f=1MHz$	-	13	-	nF
Output Capacitance	C_{oss}		-	2.2	-	nF
Reverse Transfer Capacitance	C_{iss}		-	0.45	-	nF
Turn-On Delay Time	$t_{d(on)}$	$V_{DD}=1/2V_{DSS}$	-	140	-	ns
Rise Time	t_r	$I_D=40A$	-	110	-	
Turn-Off Delay Time	$t_{d(off)}$	$V_{GS}=-5V, +10V$	-	300	-	
Fall Time	t_f	$R_C=7\Omega$	-	50	-	

FREE WHEELING DIODES RATINGS & CHARACTERISTICS ($T_c=25^\circ C$)

Characteristic	Symbol	Test Condition	Min.	Typ.	Max.	Unit
Continuous Source Current	I_S	D.C.	-	-	60	A
Pulsed Source Current	I_{SM}	-	-	-	170	A
Diode Forward Voltage	V_{SD}	$I_S=85A$	-	-	2.0	V
Reverse Recovery Time	t_{rr}	$I_S=85A, -dis/dt=100A/\mu s$	-	100	-	ns
Reverse Recovery	Q_r		-	0.15	-	μC

THERMAL CHARACTERISTICS

Characteristic	Symbol	Test Condition	Min.	Typ.	Max.	Unit
Thermal Resistance, Junction to Case	$R_{th(j-c)}$	MOS FET	-	-	0.171	$^\circ C/W$
		Diode	-	-	1.2	
Thermal Resistance, Case to Heatsink	$R_{th(c-h)}$	Mounting surface flat, smooth, and greased	-	-	0.1	$^\circ C/W$

PD10M44xH

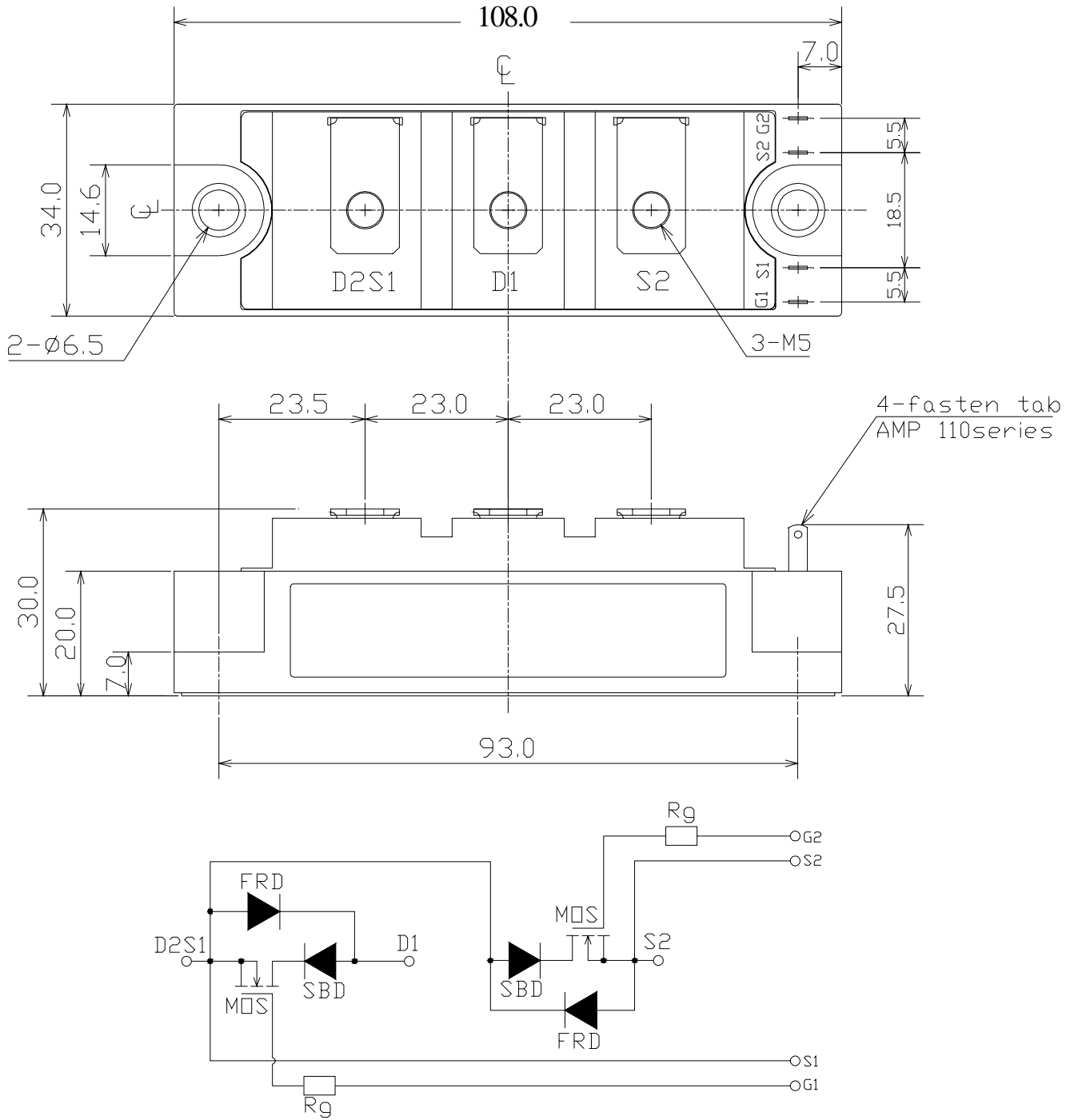

Fig. 1 Typical Output Characteristics

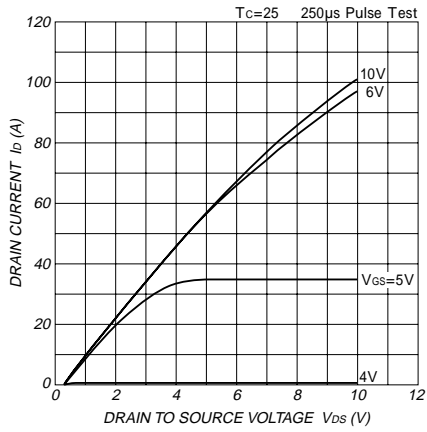

Fig. 2 Typical Drain-Source On-Voltage Vs. Gate-Source Voltage

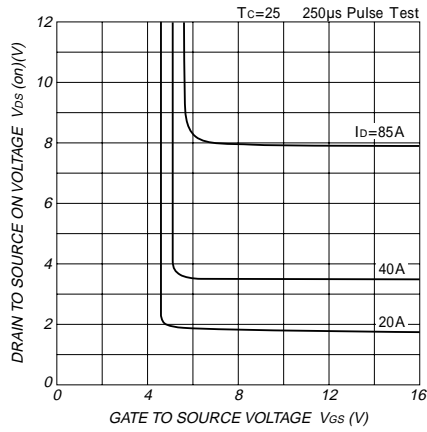

Fig. 3 Typical Drain-Source On Voltage Vs. Junction Temperature

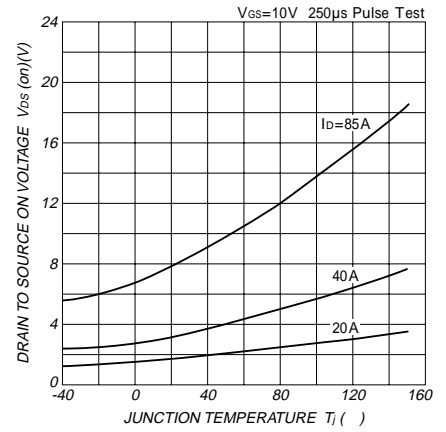

Fig. 4 Typical Capacitance Vs. Drain-Source Voltage

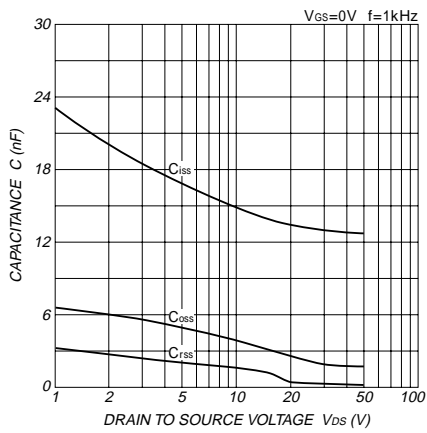

Fig. 5 Typical Gate Charge Vs. Gate-Source Voltage

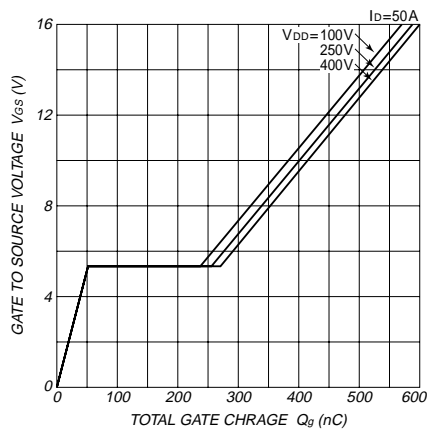

Fig. 6 Typical Switching Time Vs. Series Gate Impedance

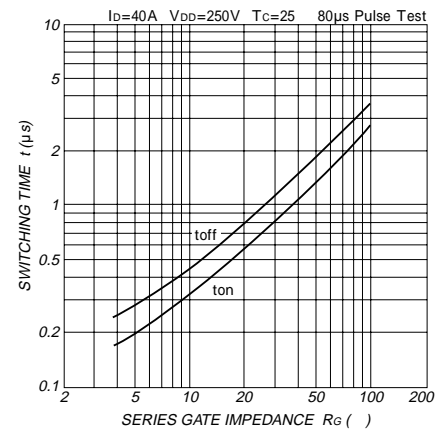

Fig. 7 Typical Switching Time Vs. Drain Current

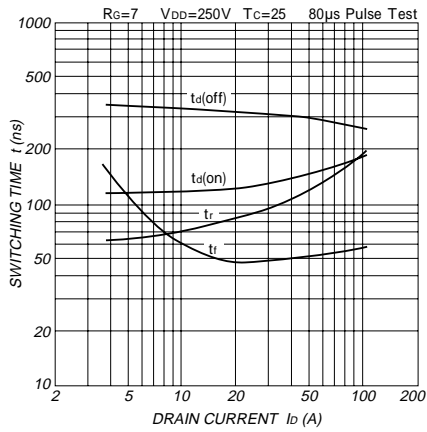

Fig. 8 Typical Source-Drain Diode Forward Characteristics

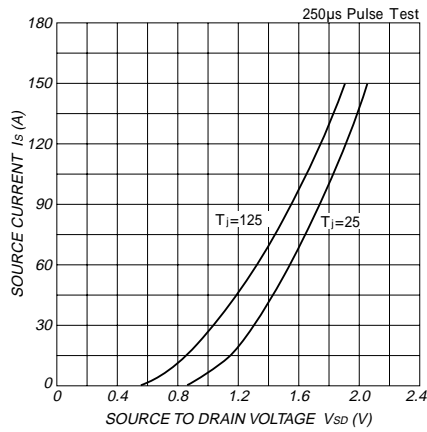

Fig. 9 Typical Reverse Recovery Characteristics

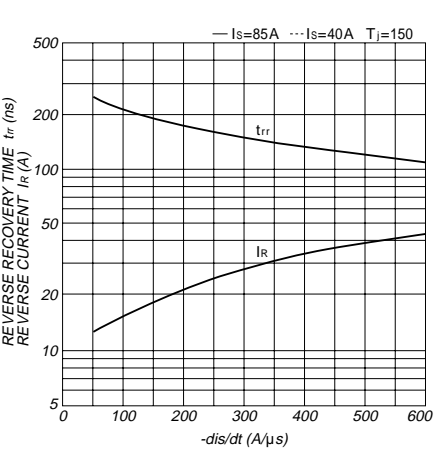

Fig. 10 Maximum Safe Operating Area

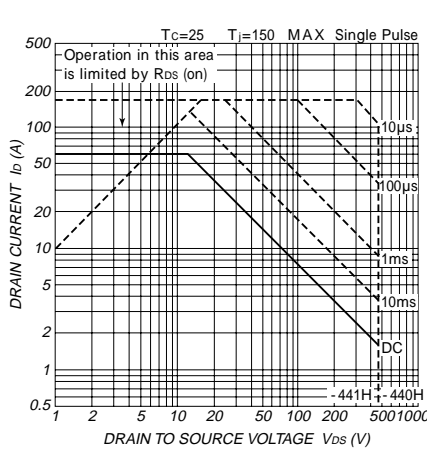

Fig. 11-1 Normalized Transient Thermal Impedance (MOSFET)

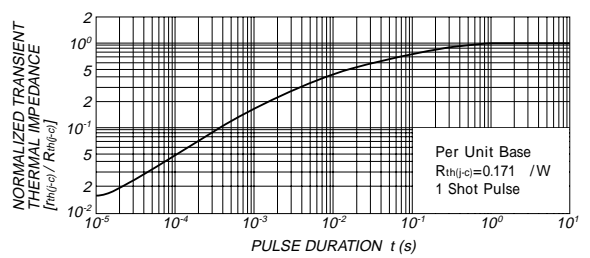

Fig. 11-2 Normalized Transient Thermal Impedance (DIODE)

