

# MN39160FH

## 4.5 mm (type-1/4) 680k-pixel CCD Area Image Sensor

### ■ Overview

The MN39160FH is a 4.5 mm (type-1/4) interline transfer CCD (IT-CCD) solid state image sensor device.

This device uses photodiodes in the optoelectric conversion section and CCDs for signal readout. The electronic shutter function has made an exposure time of 1/10000 seconds possible. Further, this device has the features of high sensitivity, low noise, broad dynamic range, and low smear.

This device has a total of 681 739 pixels (1 007 horizontal × 677 vertical) and provides stable and clear images with a resolution of 600 horizontal TV-lines and 420 vertical TV-lines.

Part Number	Size	System	Color or B/W
MN39160FH	4.5 mm (type-1/4)	NTSC	Color

### ■ Features

- Effective pixel number 962 (horizontal) × 654 (vertical)
- High sensitivity
- Broad dynamic range
- Low smear
- Electronic shutter

### ■ Applications

- Camcorders
- FA, OA cameras

### ■ Pin Assignment

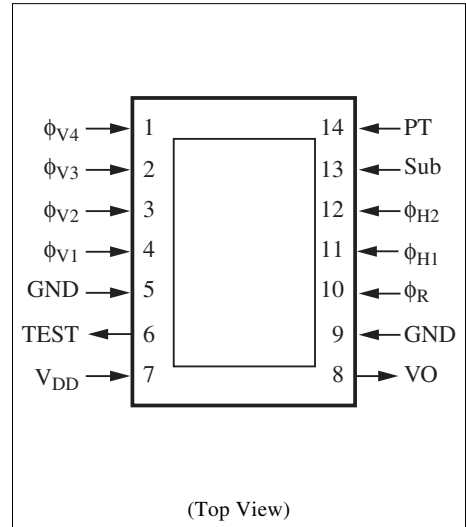

■ Block Diagram

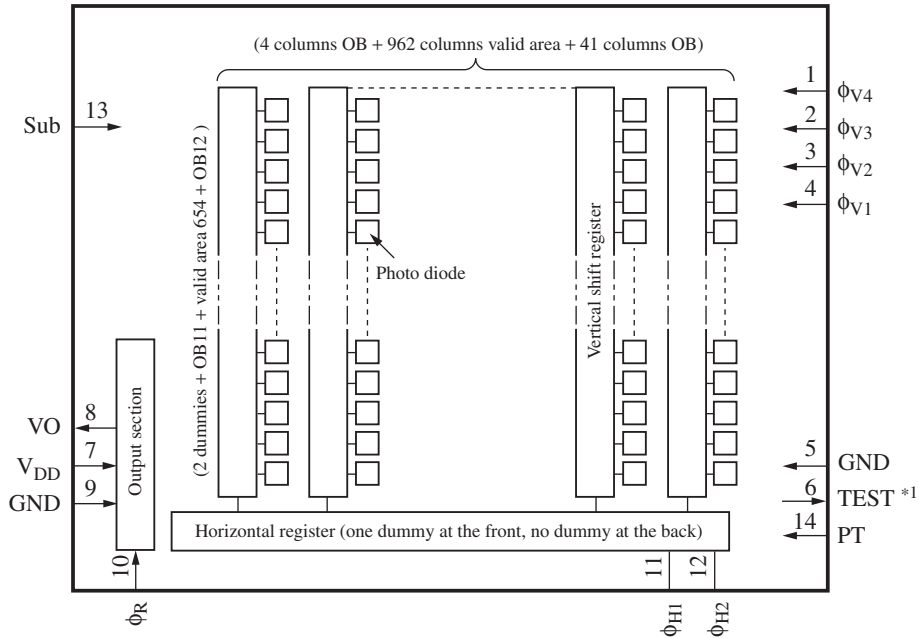

\*1 : TEST pin must be left open, because the pin outputs CCD internal bias voltage.

■ Pin Descriptions

Pin No.	Symbol	Descriptions	Pin No.	Symbol	Descriptions
1	$\phi_{V4}$	Vertical shift register clock pulse 4	8	VO	Video output
2	$\phi_{V3}$	Vertical shift register clock pulse 3	9	GND	GND
3	$\phi_{V2}$	Vertical shift register clock pulse 2	10	$\phi_R$	Reset pulse (RG)
4	$\phi_{V1}$	Vertical shift register clock pulse 1	11	$\phi_{H1}$	Horizontal register clock pulse 1
5	GND	GND	12	$\phi_{H2}$	Horizontal register clock pulse 2
6	TEST	TEST pin (OPEN) *1	13	Sub	Substrate
7	$V_{DD}$	Power supply	14	PT	P-well for protection circuit

Note) \*1: TEST pin must be left open, because the pin outputs CCD internal bias voltage.

■ Device Parameter (H × V)

Parameter	Value	Unit
Pixel number *1	962 × 654	pixel
Image sensing block dimension	3.6556 × 2.7141	mm <sup>2</sup>
Pixel dimension	3.80 × 4.15	μm <sup>2</sup>

Note) \*1: OB columns are not included.

### ■ Absolute Maximum Ratings and Operating Conditions

Parameter		Absolute maximum rating		Operating condition			Unit
		Lower limit	Upper limit	min	typ	max	
$V_{DD}$		-0.2	18	14.5	15.0	15.5	V
$V_{PT}^{*3,4}$		-10.0	0.2	-7.5	-7.0	-6.5	V
GND		(Reference voltage)		—	0	—	V
$V_{\phi R}$	High-Low	—	8	3.0	3.3	3.6	V
	Bias	(Supplied internally)					V
$V_{\phi H1}$	High	—	8	3.0	3.3	3.6	V
	Low	-0.2	—	-0.2	0	0.2	V
$V_{\phi H2}$	High	—	8	3.0	3.3	3.6	V
	Low	-0.2	—	-0.2	0	0.2	V
$V_{Sub}^{*2}$		(Supplied internally)					V
$\phi V_{Sub}^{*1}$		-0.2	35	21.0	22.0	23.0	V
$V_{\phi V1}^{*3,4}$	High	—	18	14.5	15.0	15.5	V
	Middle	—	—	-0.05	0	0.05	V
	Low	-9	—	-7.5	-7.0	-6.5	V
$V_{\phi V2}^{*3,4}$	Middle	—	15	-0.05	0	0.05	V
	Low	-9	—	-7.5	-7.0	-6.5	V
$V_{\phi V3}^{*3,4}$	High	—	18	14.5	15.0	15.5	V
	Middle	—	—	-0.05	0	0.05	V
	Low	-9	—	-7.5	-7.0	-6.5	V
$V_{\phi V4}^{*3,4}$	Middle	—	15	-0.05	0	0.05	V
	Low	-9	—	-7.5	-7.0	-6.5	V
Operating temperature		-10	60	—	25	—	°C
Storage temperature		-30	80	—	—	—	°C

■ Absolute Maximum Ratings and Operating Conditions (continued)

Note) 1. Standard photo detecting condition

Standard photo detecting condition stands for detecting image with a light source of color temperature of 2856K, luminance of 1050 cd/m<sup>2</sup>, and using a color temperature conversion filter LB-40 (HOYA), infrared cut filter CAW-500S with thickness 2.5 mm for a light path and with F8 lens aperture. The quantity of the incidental light to a photo-detecting surface under the above condition is defined as the standard quantity of light.

2. \*1:  $V_{Sub}$  when using electronic shutter function

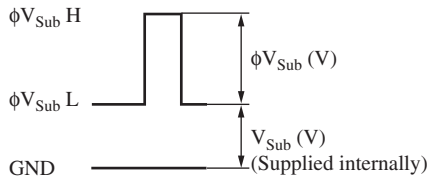

\*  $\phi Sub$  pulse generates once every 1 V period.

\*2:  $V_{Sub}$  supplied internally is the voltage suppressing the blooming generation at  $\times 500$  light quantity relative to the standard light quantity.

\*3: Relation between  $V_{PT}$  and  $V_{\phi VL}$

Set  $V_{PT}$  under the following condition against VL of a vertical transfer clock waveform.

$$V_{PT} \leq VL \text{ (} V_{\phi V1L} \text{ to } V_{\phi V4L} \text{)}$$

\*4: Absolute maximum ratings  $-0.2 < V_{\phi V} - V_{PT} < 24.5 \text{ (V)}$

■ Optical Characteristics

Parameter	Symbol	Conditions	Min	Typ	Max	Unit
Carrier saturation output	Sc	J chart	500	—	—	mV
Sensitivity	So	J chart F1.4, 1/32 ND	80	110	—	mV
Vertical smear	Sm	1/10 V chart, F1.4	—	—	0.01	%

Note) The above-mentioned characteristics are the values on driving the device for the imaging stabilizer mode (1/60 seconds accumulation).

■ Timing Diagram

- High speed pulse timing

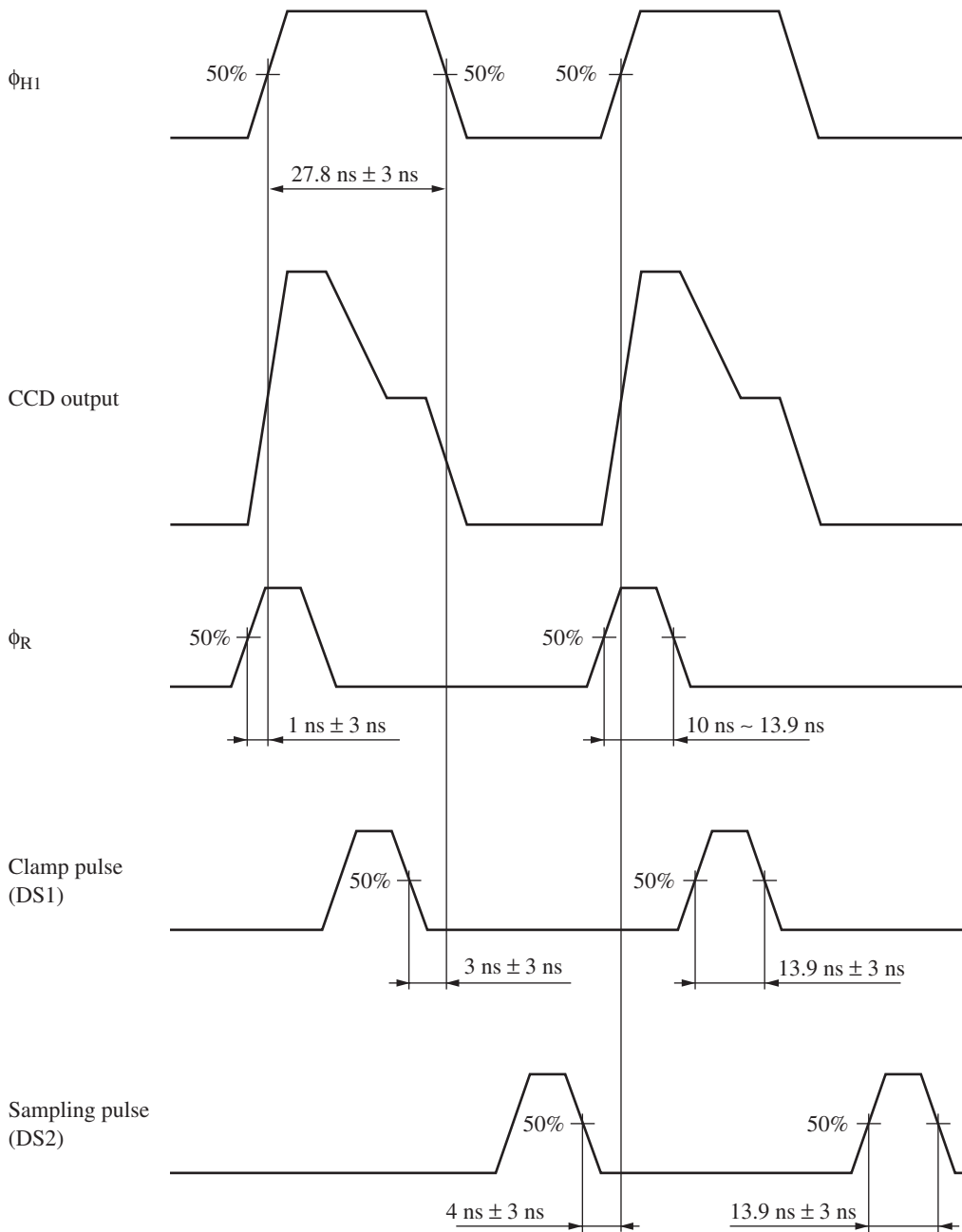

■ Timing Diagram (continued)

- Rise time and fall time of each pulse

$\phi_{V1}, \phi_{V3}$

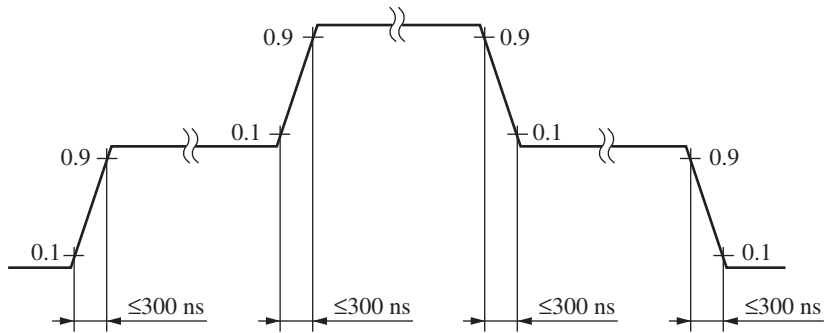

$\phi_{V2}, \phi_{V4}$

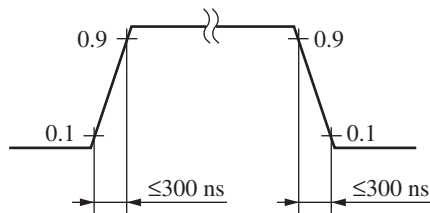

$\phi_{H1}, \phi_{H2}$

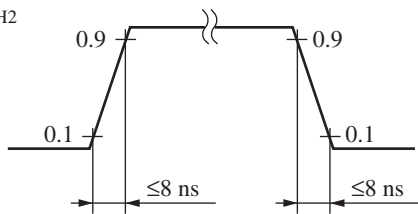

$\phi_R$

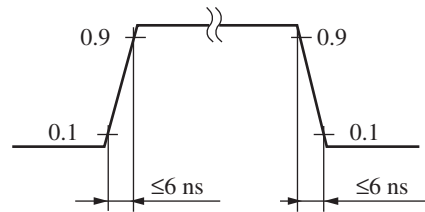

■ Color Filter Arrays for CCD

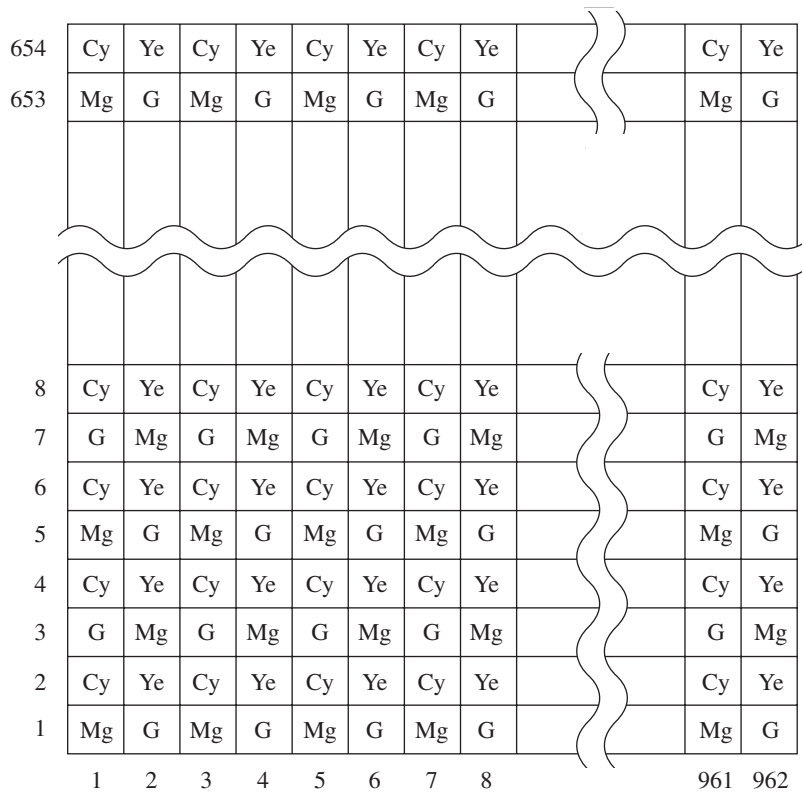

■ Graph of Characteristics

CCD color filter spectral characteristics

