

MAXIM

MAX1999 Evaluation Kit

General Description

The MAX1999 evaluation kit (EV kit) demonstrates the MAX1999's standard application circuit. This DC-DC converter steps down high-voltage batteries and/or AC adapters, generating system supplies for notebook computers. The MAX1999 EV kit provides dual 5V and 3.3V output voltages from a 7V to 24V battery input range. It delivers up to 5A output current for the 5V output and 5A for the 3.3V output with greater than 90% efficiency. The EV kit operates at 200kHz/300kHz switching frequency (5V/3.3V, respectively) and has superior line-and-load-transient response.

This EV kit is a fully assembled and tested circuit board. It allows the evaluation of other output voltages in the 2V to 5.5V range by changing feedback resistors R1–R4.

This EV kit can also be used to evaluate the MAX1777 (200kHz/5.0V SMPS and 300kHz/3.3V SMPS) and the MAX1977 (400kHz/5.0V SMPS and 500kHz/3.3V SMPS).

Features

- ◆ 7V to 24V Input Voltage Range
- ◆ 3.3V and 5V Output Voltages
- ◆ 2V to 5.5V Adjustable Outputs (External Resistors)
- ◆ 5A Output Current (3.3V Output)
- ◆ 5A Output Current (5V Output)
- ◆ No Current-Sense Resistor Needed (MAX1999)
- ◆ Accurate Current Sense with Current-Sense Resistor (MAX1777/MAX1977)
- ◆ 200kHz/300kHz Switching Frequency (5V/3.3V, Respectively)
- ◆ Power-Good (PGOOD) Output
- ◆ Fault Protection Enable/Disable
- ◆ 28-Pin QSOP Package
- ◆ Low-Profile Components
- ◆ Fully Assembled and Tested

Ordering Information

PART	TEMP RANGE	IC PACKAGE
MAX1999EVKIT	0°C to +70°C	28 QSOP

Note: To evaluate the MAX1777/MAX1977, request a MAX1777EEI/MAX1977EEI free sample with the MAX1999EVKIT.

Component List

DESIGNATION	QTY	DESCRIPTION
C1, C2, C3	3	10µF, 25V ceramic capacitors (1812) Taiyo Yuden TMK432BJ106KM or TDK C4532X5R1E106M
C4	0	Not installed (1812)
C5, C7	0	Not installed, D case
C6	1	470µF, 4V, 40mΩ, low-ESR capacitor, D case Sanyo 4TPB470M
C8	1	330µF, 6.3V, 40mΩ, low-ESR capacitor, D case Sanyo 6TPB330M
C9, C10, C12, C15	4	0.1µF ceramic capacitors (0805)
C11, C24	2	1µF, 10V X5R ceramic capacitors (0805) Taiyo Yuden LMK212BJ105KG or TDK C2012X5R105M

DESIGNATION	QTY	DESCRIPTION
C13, C14	0	Not installed
C16	1	0.22µF, 16V X5R ceramic capacitor (0805) Taiyo Yuden EMK212BJ224KG
C17	1	4.7µF, 35V tantalum capacitor, C case Sprague 595D475X0035C2B
C18, C19	2	4.7µF, 16V tantalum capacitors, A case Sprague 595D475X0016A2B
D1	1	100mA, 30V dual Schottky diode Central Semiconductor CMPSH-3A
D2, D3	2	1A, 30V Schottky diodes Nihon EP10QY03 Toshiba CRS02
JU1, JU2	2	3-pin headers
JU3, JU5	2	4-pin headers

MAX1999 Evaluation Kit

Component List (continued)

DESIGNATION	QTY	DESCRIPTION
L1	1	7.6μH, 5.9A power inductor Sumida CDRH127-7R6
L2	1	4.7μH, 5.7A power inductor Sumida CDRH124-4R7
N1, N3	2	N-channel MOSFET, 8-pin SO International Rectifier IRF7807V or Fairchild FDS6612A
N2, N4	2	N-channel MOSFET, 8-pin SO International Rectifier IRF7811AV or Fairchild FDS6670A
R1, R3, R10–R14	0	Not installed (0805)
R2, R4	0	Not installed, short PC trace (0805)
R5	1	3.9Ω ±5% resistor (1206)

DESIGNATION	QTY	DESCRIPTION
R6	1	100kΩ ±5% resistor (0805)
R7, R9	2	1MΩ ±5% resistors (0805)
R8, R18	2	10Ω ±5% resistors (0805)
R15, R16	0	Not installed, short PC trace (2010)
R17	1	47Ω ±5% resistor (0805)
U1	1	MAX1999EEI, 28-pin QSOP
None	4	Shunts (JU1, JU2, JU3, JU5)
None	4	Rubber feet
None	1	MAX1999 PC board
None	1	MAX1999 data sheet
None	1	MAX1999 EV kit data sheet

Component Suppliers

SUPPLIER	PHONE	FAX	WEBSITE
Central Semiconductor	516-435-1110	516-435-1824	www.centralsemi.com
Fairchild	408-721-2181	408-721-1635	www.fairchildsemi.com
International Rectifier	310-322-3331	310-322-3332	www.irf.com
Nihon	847-843-7500	847-843-2798	www.niec.co.jp
Sanyo	619-661-6835	619-661-1055	www.sumida.com
Sprague/Vishay	270-324-4140	270-490-7222	www.vishay.com
Sumida	708-956-0666	708-956-0702	www.sumida.com
Taiyo Yuden	408-573-4150	408-573-4159	www.t-yuden.com
TDK	847-390-4373	847-390-4428	www.component.tdk.com

Note: Please indicate that you are using the MAX1999 when contacting these component suppliers.

Recommended Equipment

- 7V to 24V power supply, battery, or notebook AC adapter
- Dummy loads capable of sinking 5A
- Digital multimeters (DMMs)
- 100MHz dual-trace oscilloscope

Quick Start

- 1) Ensure that the circuit is connected correctly to the supplies and dummy load before applying any power.

- 2) Verify that the shunts are across JU1 pins 1 and 2, JU2 pins 1 and 2, JU3 pins 1 and 4, and JU5 pins 1 and 4.
- 3) Turn on the power supply.
- 4) Verify that the output voltages are 3.3V and 5V.

Evaluating Other Output Voltages

The EV kit outputs are preset to 3.3V and 5V. However, the output voltages can also be adjusted between 2V and 5.5V by selecting R1/R2 and R3/R4 values. Select feedback resistors R2 and R4.

R1 and R3 are then given by:

$$R1 \text{ (or } R3) = R2 \text{ (or } R4) \times [(V_{OUT}/V_{FB}) - 1]$$

where $V_{FB} = 2V$.

MAX1999 Evaluation Kit

Evaluates: MAX1777/MAX1977/MAX1999

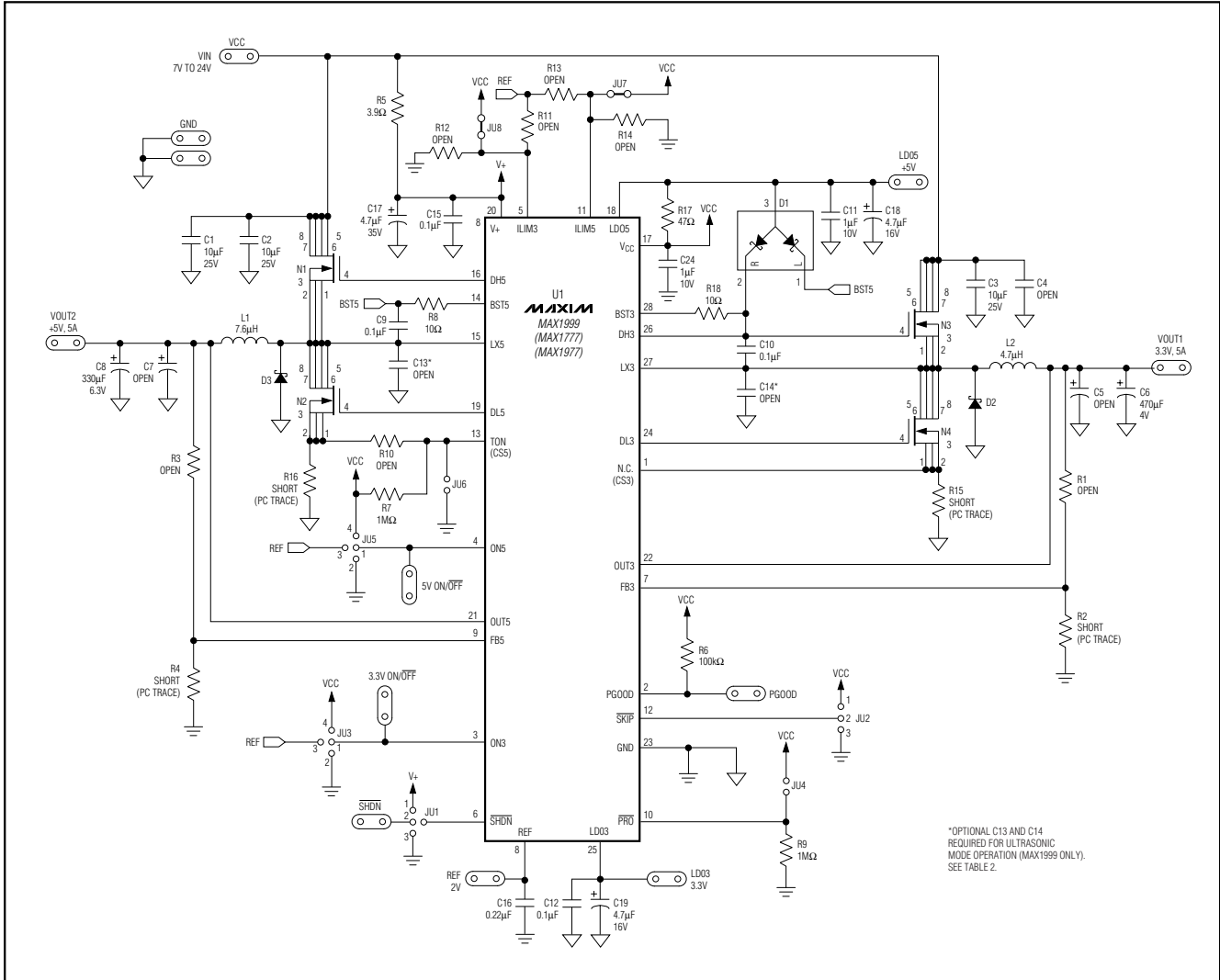

Figure 1. MAX1999 EV Kit Schematic

Evaluating the MAX1777/MAX1977

This EV kit also can be used to evaluate the MAX1777/MAX1977. The MAX1777 operates at 200kHz/300kHz switching frequency and the MAX1977 operates at 400kHz/500kHz switching frequency (5V/3.3V). The MAX1777 and the MAX1977 use accurate current-sense resistors, R15 and R16:

- 1) Remove the MAX1999 and install a MAX1777 or MAX1977.
- 2) Cut open the traces shorting sense resistors R15 and R16.
- 3) Install sense resistors R15 and R16.
- 4) Short resistor R10 (leave JU6 open).

MAX1999 Evaluation Kit

Jumper Settings

Table 1. Jumper JU1 Functions ($\overline{\text{SHDN}}$ Mode Selection)

JU1	$\overline{\text{SHDN}}$ PIN	MAX1999 OUTPUT
1 and 2	Connected to V+	MAX1999 enabled; REF, LDO3, and LDO5 active; V_{OUT1} (3.3V) depends on JU3; V_{OUT2} (5.0V) depends on JU5
2 and 3	Connected to GND	Shutdown mode; REF, LDO3, and LDO5 off; $V_{\text{OUT1}} = 0V$ and $V_{\text{OUT2}} = 0V$
Not installed	Connected to $\overline{\text{SHDN}}$ pad	MAX1999 can be driven by an external signal

Table 2. Jumper JU2 Functions (SKIP Mode Selection)

JU2	$\overline{\text{SKIP}}$ PIN	OPERATING MODE
1 and 2	Connected to VCC	Low-noise mode, forced fixed-frequency PWM operation.
2 and 3	Connected to GND	Normal operation, allows automatic PWM/PFM switchover for pulse-skipping at light load, resulting in highest efficiency.
Not installed	Floating	Ultrasonic pulse-skipping mode (20kHz min). Install C13, C14 (470pF) for MAX1999 ultrasonic mode operation to ensure proper negative ultrasonic current sensing ($V_{\text{NEG}}(\mu\text{s})$).

Table 3. Jumper JU3 Functions (Output Voltage V_{OUT1} Control)

JU3	ON3 PIN	OUTPUT VOLTAGE (V_{OUT1})
1 and 2	Connected to GND	$V_{\text{OUT1}} = 0V$, disabled
1 and 3	Connected to REF (ON5 = VCC)	V_{OUT1} (3.3V) starts after V_{OUT2} (5V) reaches regulation
1 and 4	Connected to VCC	$V_{\text{OUT1}} = 3.3V$, enabled

Table 4. Jumper JU4 Functions (Protection Selection)

JU4	$\overline{\text{PRO}}$ PIN	PROTECTION
Installed	Connected to VCC	Undervoltage and overvoltage fault protection are disabled.
Not installed	Connected to GND through resistor R9	Undervoltage and overvoltage fault protection are enabled. Refer to the <i>Fault Protection</i> section in the MAX1999 data sheet for more information.

MAX1999 Evaluation Kit

Jumper Settings (continued)

Table 5. Jumper JU5 Functions (Output Voltage V_{OUT2} Control)

JU5	ON5 PIN	OUTPUT VOLTAGE (V _{OUT2})
1 and 2	Connected to GND	V _{OUT2} = 0V, disabled
1 and 3	Connected to REF (ON3 = VCC)	V _{OUT2} (5V) starts after V _{OUT1} (3.3V) reaches regulation
1 and 4	Connected to VCC	V _{OUT2} = 5V, enabled

Table 6. Jumper JU6 Functions (Switching-Frequency Selection)

JU6	TON PIN	FREQUENCY (kHz)
Not installed	Connected to VCC through resistor R7	200/300 (as shipped)
Installed	Connected to GND	400/500

Important: Do not change the operating frequency without first recalculating component values. The switching frequency has a significant effect on the peak current-limit level, MOSFET heating, preferred inductor value, PFM/PWM switchover point, output noise, efficiency, and other critical parameters.

Table 7. Jumper JU7 Functions (Fixed/Adjustable Current-Limit Selection for V_{OUT2})

JU7	ILIM5 PIN	CURRENT-LIMIT THRESHOLD (mV)
SHORT	Connected to VCC through a PC board trace.	100 (default)
OPEN	Connected to REF through resistor-divider R13/R14. Refer to the <i>Current-Limit Circuit</i> section in the MAX1999 data sheet for information on selecting R13/R14.	Adjustable from 50 to 200

Table 8. Jumper JU8 Functions (Fixed/Adjustable Current-Limit Selection for V_{OUT1})

JU8	ILIM3 PIN	CURRENT-LIMIT THRESHOLD (mV)
SHORT	Connected to VCC through a PC board trace.	100 (default)
OPEN	Connected to REF through resistor-divider R11/R12. Refer to the <i>Current-Limit Circuit</i> section in the MAX1999 data sheet for information on selecting R11/R12.	Adjustable from 50 to 200

Evaluates: MAX1777/MAX1977/MAX1999

MAX1999 Evaluation Kit

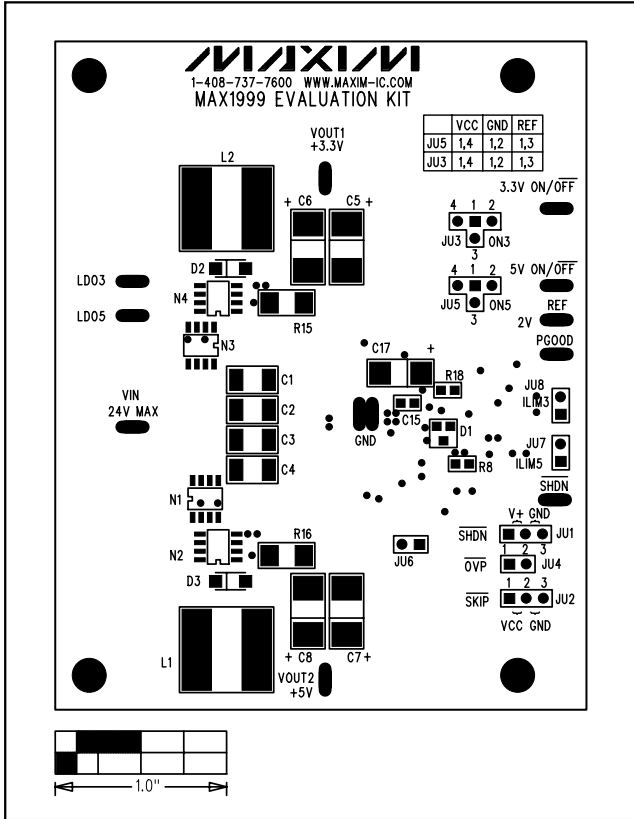

Figure 2. MAX1999 EV Kit Component Placement Guide—Top Silkscreen

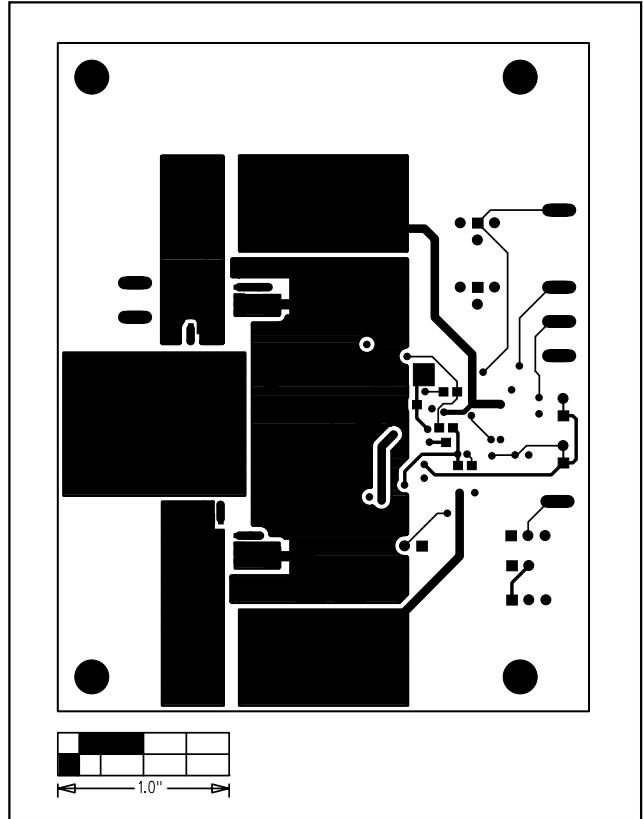

Figure 3. MAX1999 EV Kit PC Board Layout—Component Side

MAX1999 Evaluation Kit

Evaluates: MAX1777/MAX1977/MAX1999

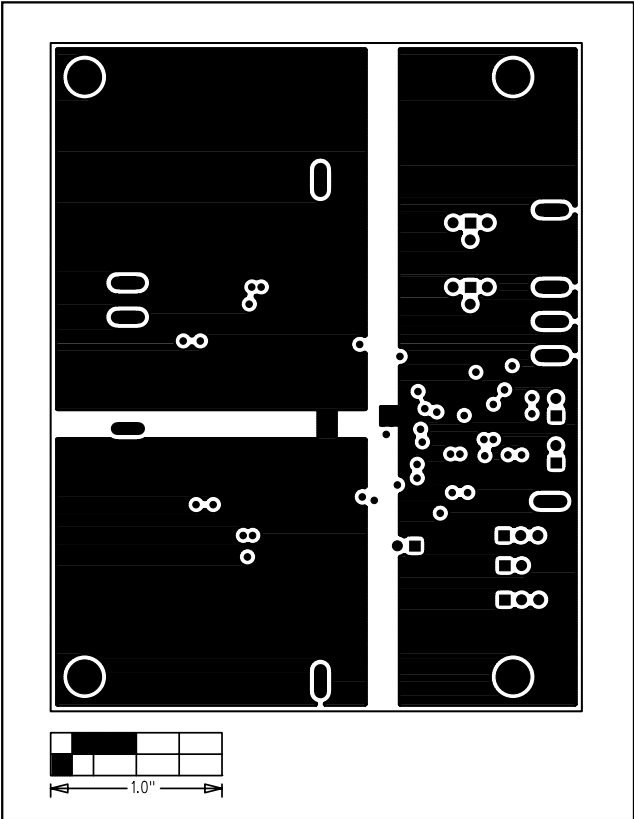

Figure 4. MAX1999 EV Kit PC Board Layout—Ground Layer 2

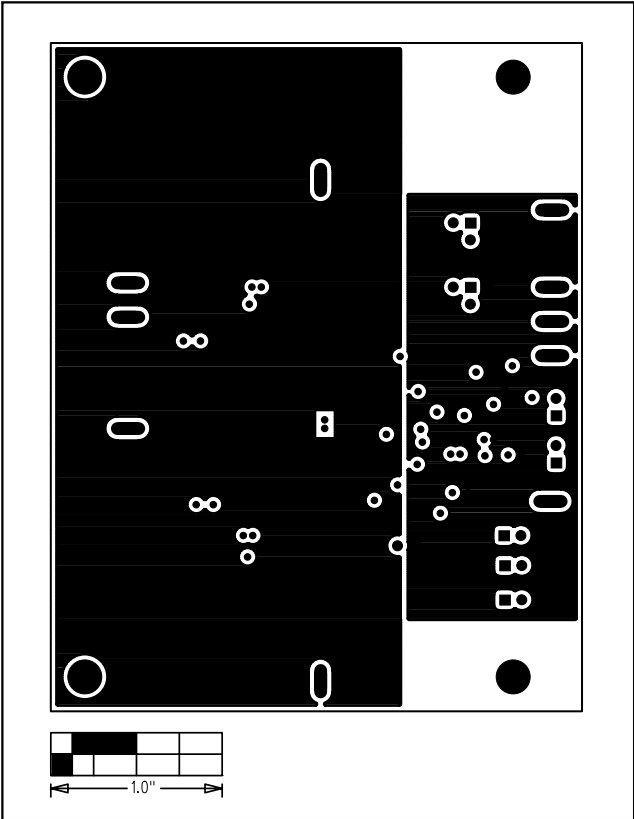

Figure 5. MAX1999 EV Kit PC Board Layout—Ground Layer 3

MAX1999 Evaluation Kit

Evaluates: MAX1777/MAX1977/MAX1999

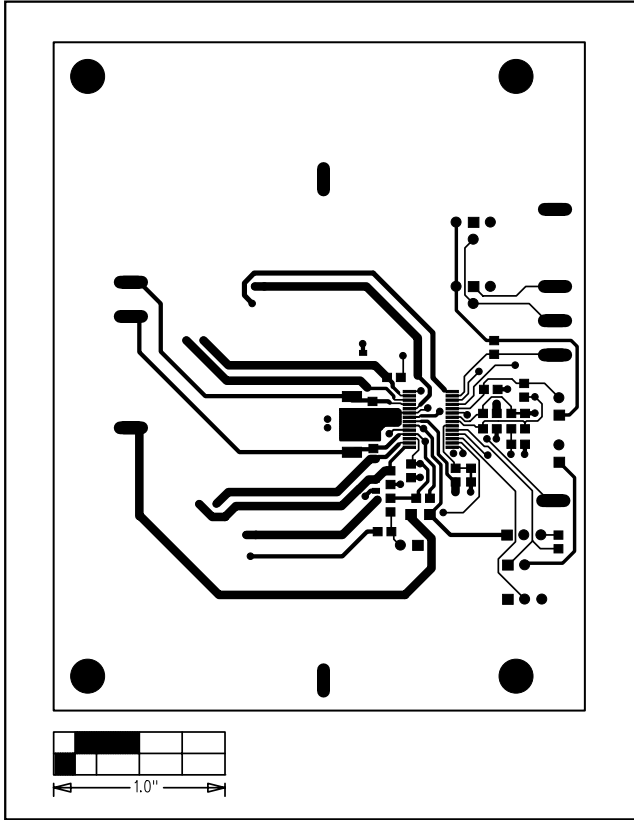

Figure 6. MAX1999 EV Kit PC Board Layout—Solder Side

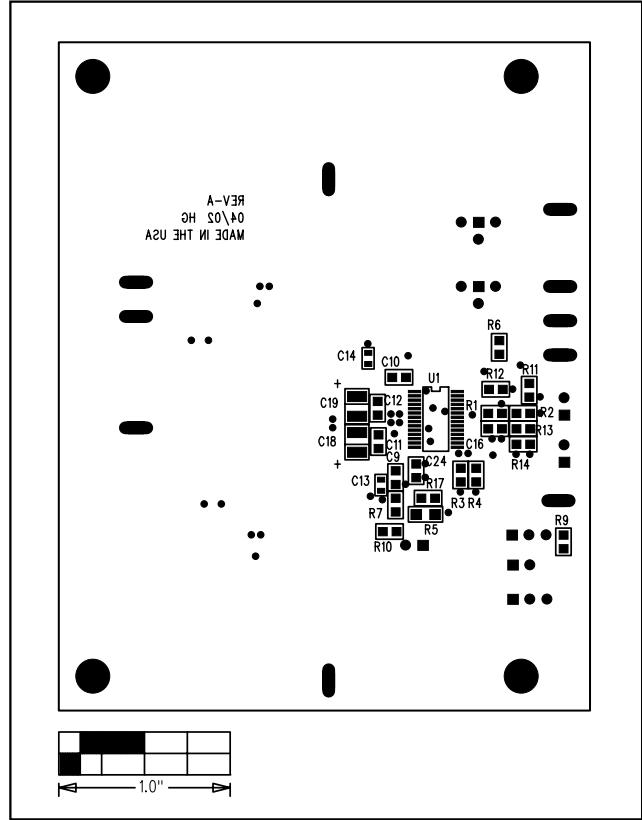

Figure 7. MAX1999 EV Kit Component Placement Guide—Bottom Silkscreen

Maxim cannot assume responsibility for use of any circuitry other than circuitry entirely embodied in a Maxim product. No circuit patent licenses are implied. Maxim reserves the right to change the circuitry and specifications without notice at any time.

8 _____ Maxim Integrated Products, 120 San Gabriel Drive, Sunnyvale, CA 94086 408-737-7600