

**RADIATION HARDENED  
 POWER MOSFET  
 THRU-HOLE (TO-254AA)**

**IRHM9150  
 JANSR2N7422  
 100V, P-CHANNEL**

REF: MIL-PRF-19500/662

**RAD Hard™ HEXFET® TECHNOLOGY**

**Product Summary**

| Part Number | Radiation Level | RDS(on) | Id   | QPL Part Number |
|-------------|-----------------|---------|------|-----------------|
| IRHM9150    | 100K Rads (Si)  | 0.080Ω  | -22A | JANSR2N7422     |
| IRHM93150   | 300K Rads (Si)  | 0.080Ω  | -22A | JANSF2N7422     |

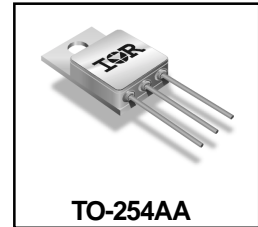

International Rectifier's RADHard HEXFET™ technology provides high performance power MOSFETs for space applications. This technology has over a decade of proven performance and reliability in satellite applications. These devices have been characterized for both Total Dose and Single Event Effects (SEE). The combination of low Rds(on) and low gate charge reduces the power losses in switching applications such as DC to DC converters and motor control. These devices retain all of the well established advantages of MOSFETs such as voltage control, fast switching, ease of paralleling and temperature stability of electrical parameters.

**Features:**

- Single Event Effect (SEE) Hardened
- Low RDS(on)
- Low Total Gate Charge
- Proton Tolerant
- Simple Drive Requirements
- Ease of Paralleling
- Hermetically Sealed
- Surface Mount
- Ceramic Package
- Light Weight

**Absolute Maximum Ratings**

**Pre-Irradiation**

|                             | Parameter                       |  | Units |
|-----------------------------|---------------------------------|--|-------|
| Id @ VGS = -12V, TC = 25°C  | Continuous Drain Current        | -22  | A     |
| Id @ VGS = -12V, TC = 100°C | Continuous Drain Current        | -14  |       |
| IDM                         | Pulsed Drain Current ①          | -88  |       |
| PD @ TC = 25°C              | Max. Power Dissipation          | 150  | W     |
|                             | Linear Derating Factor          | 1.2  | W/°C  |
| VGS                         | Gate-to-Source Voltage          | ±20  | V     |
| EAS                         | Single Pulse Avalanche Energy ② | 500  | mJ    |
| IAR                         | Avalanche Current ①             | -22  | A     |
| EAR                         | Repetitive Avalanche Energy ①   | 15   | mJ    |
| dv/dt                       | Peak Diode Recovery dv/dt ③     | -23  | V/ns  |
| TJ                          | Operating Junction              | -55 to 150                                 | °C    |
| TSTG                        | Storage Temperature Range       |  |       |
|                             | Lead Temperature                | 300 ( 0.063 in. (1.6mm) from case for 10s) |       |
|                             | Weight                          | 9.3 (typical)                              | g     |

For footnotes refer to the last page

**Electrical Characteristics @ T<sub>j</sub> = 25°C (Unless Otherwise Specified)**

|                                     | Parameter                                    | Min  | Typ    | Max   | Units | Test Conditions  |
|-------------------------------------|--|------|--------|-------|-------|--|
| BV <sub>DSS</sub>                   | Drain-to-Source Breakdown Voltage            | -100 | —      | —     | V     | V <sub>GS</sub> = 0V, I <sub>D</sub> = -1.0mA  |
| ΔBV <sub>DSS</sub> /ΔT <sub>J</sub> | Temperature Coefficient of Breakdown Voltage | —    | -0.093 | —     | V/°C  | Reference to 25°C, I <sub>D</sub> = -1.0mA   |
| R <sub>DS(on)</sub>                 | Static Drain-to-Source On-State Resistance   | —    | —      | 0.080 | Ω     | V <sub>GS</sub> = -12V, I <sub>D</sub> = -14A <sup>④</sup>                                       |
|                                     |  | —    | —      | 0.085 |       | V <sub>GS</sub> = -12V, I <sub>D</sub> = -22A <sup>④</sup>                                       |
| V <sub>GS(th)</sub>                 | Gate Threshold Voltage                       | -2.0 | —      | -4.0  | V     | V <sub>DS</sub> = V <sub>GS</sub> , I <sub>D</sub> = -1.0mA                                      |
| g <sub>fs</sub>                     | Forward Transconductance                     | 11   | —      | —     | S (f) | V <sub>DS</sub> > -15V, I <sub>DS</sub> = -14A <sup>④</sup>                                      |
| I <sub>DSS</sub>                    | Zero Gate Voltage Drain Current              | —    | —      | -25   | μA    | V <sub>DS</sub> = -80V, V <sub>GS</sub> = 0V   |
|                                     |  | —    | —      | -250  |       | V <sub>DS</sub> = -80V,<br>V <sub>GS</sub> = 0V, T <sub>J</sub> = 125°C                          |
| I <sub>GSS</sub>                    | Gate-to-Source Leakage Forward               | —    | —      | -100  | nA    | V <sub>GS</sub> = -20V   |
| I <sub>GSS</sub>                    | Gate-to-Source Leakage Reverse               | —    | —      | 100   |       | V <sub>GS</sub> = 20V  |
| Q <sub>g</sub>                      | Total Gate Charge                            | —    | —      | 200   | nC    | V <sub>GS</sub> = -12V, I <sub>D</sub> = -22A<br>V <sub>DS</sub> = -50V                          |
| Q <sub>gs</sub>                     | Gate-to-Source Charge                        | —    | —      | 35    |       |  |
| Q <sub>gd</sub>                     | Gate-to-Drain ('Miller') Charge              | —    | —      | 48    |       |  |
| t <sub>d(on)</sub>                  | Turn-On Delay Time                           | —    | —      | 40    | ns    | V <sub>DD</sub> = -50V, I <sub>D</sub> = -22A,<br>V <sub>GS</sub> = -12V, R <sub>G</sub> = 2.35Ω |
| t <sub>r</sub>                      | Rise Time                                    | —    | —      | 170   |       |  |
| t <sub>d(off)</sub>                 | Turn-Off Delay Time                          | —    | —      | 190   |       |  |
| t <sub>f</sub>                      | Fall Time                                    | —    | —      | 190   |       |  |
| L <sub>S</sub> + L <sub>D</sub>     | Total Inductance                             | —    | 6.8    | —     | nH    | Measured from drain lead (6mm/0.25in. from package) to source lead (6mm/0.25in. from package)    |
| C <sub>iss</sub>                    | Input Capacitance                            | —    | 4300   | —     | pF    | V <sub>GS</sub> = 0V, V <sub>DS</sub> = -25V<br>f = 1.0MHz                                       |
| C <sub>oss</sub>                    | Output Capacitance                           | —    | 1100   | —     |       |  |
| C <sub>rss</sub>                    | Reverse Transfer Capacitance                 | —    | 310    | —     |       |  |

**Source-Drain Diode Ratings and Characteristics**

|                 | Parameter                                      | Min  | Typ | Max  | Units | Test Conditions   |
|-----------------|--|--|-----|------|-------|---|
| I <sub>S</sub>  | Continuous Source Current (Body Diode)         | —  | —   | -22  | A     |   |
| I <sub>SM</sub> | Pulse Source Current (Body Diode) <sup>①</sup> | —  | —   | -88  |       |   |
| V <sub>SD</sub> | Diode Forward Voltage                          | —  | —   | -3.0 | V     | T <sub>j</sub> = 25°C, I <sub>S</sub> = -22A, V <sub>GS</sub> = 0V <sup>④</sup> |
| t <sub>rr</sub> | Reverse Recovery Time                          | —  | —   | 300  | rS    | T <sub>j</sub> = 25°C, I <sub>F</sub> = -22A, di/dt ≤ -100A/μs                  |
| Q <sub>RR</sub> | Reverse Recovery Charge                        | —  | —   | 1.5  | μC    | V <sub>DD</sub> ≤ -50V <sup>④</sup>   |
| t <sub>on</sub> | Forward Turn-On Time                           | Intrinsic turn-on time is negligible. Turn-on speed is substantially controlled by L <sub>S</sub> + L <sub>D</sub> . |     |      |       |   |

**Thermal Resistance**

|                   | Parameter           | Min | Typ  | Max  | Units | Test Conditions      |
|-------------------|---------------------|-----|------|------|-------|----------------------|
| R <sub>thJC</sub> | Junction-to-Case    | —   | —    | 0.83 | °C/W  | Typical socket mount |
| R <sub>thJA</sub> | Junction-to-Ambient | —   | —    | 48   |       |                      |
| R <sub>thCS</sub> | Case-to-Sink        | —   | 0.21 | —    |       |                      |

**Note:** Corresponding Spice and Saber models are available on the G&S Website.

For footnotes refer to the last page

International Rectifier Radiation Hardened MOSFETs are tested to verify their radiation hardness capability. The hardness assurance program at International Rectifier is comprised of two radiation environments. Every manufacturing lot is tested for total ionizing dose (per notes 5 and 6) using the TO-3 package. Both pre- and post-irradiation performance are tested and specified using the same drive circuitry and test conditions in order to provide a direct comparison.

**Table 1. Electrical Characteristics @ Tj = 25°C, Post Total Dose Irradiation ⑤⑥**

| Parameter           |  | 100K Rads (Si) <sup>1</sup> |       | 300K Rads (Si) <sup>2</sup> |       | Units | Test Conditions   |
|---------------------|--|-----------------------------|-------|-----------------------------|-------|-------|---|
|                     |  | Min                         | Max   | Min                         | Max   |       |   |
| BVDSS               | Drain-to-Source Breakdown Voltage                        | -100                        | —     | -100                        | —     | V     | V <sub>GS</sub> = 0V, I <sub>D</sub> = -1.0mA               |
| V <sub>GS(th)</sub> | Gate Threshold Voltage                                   | -2.0                        | -4.0  | -2.0                        | -5.0  |       | V <sub>GS</sub> = V <sub>DS</sub> , I <sub>D</sub> = -1.0mA |
| I <sub>GSS</sub>    | Gate-to-Source Leakage Forward                           | —                           | -100  | —                           | -100  | nA    | V <sub>GS</sub> = -20V                                      |
| I <sub>GSS</sub>    | Gate-to-Source Leakage Reverse                           | —                           | 100   | —                           | 100   |       | V <sub>GS</sub> = 20 V                                      |
| I <sub>DSS</sub>    | Zero Gate Voltage Drain Current                          | —                           | -25   | —                           | -25   | μA    | V <sub>DS</sub> = -80V, V <sub>GS</sub> = 0V                |
| R <sub>DS(on)</sub> | Static Drain-to-Source ④<br>On-State Resistance (TO-3)   | —                           | 0.080 | —                           | 0.080 | Ω     | V <sub>GS</sub> = -12V, I <sub>D</sub> = -14A               |
| R <sub>DS(on)</sub> | Static Drain-to-Source ④<br>On-State Resistance (TO-254) | —                           | 0.080 | —                           | 0.080 | Ω     | V <sub>GS</sub> = -12V, I <sub>D</sub> = -14A               |
| V <sub>SD</sub>     | Diode Forward Voltage ④                                  | —                           | -3.0  | —                           | -3.0  | V     | V <sub>GS</sub> = 0V, I <sub>S</sub> = -22A                 |

1. Part number IRHM9150 (JANSR2N7422)  
 2. Part number IRHM93150 (JANSF2N7422)

International Rectifier radiation hardened MOSFETs have been characterized in heavy ion environment for Single Event Effects (SEE). Single Event Effects characterization is illustrated in Fig. a and Table 2.

**Table 2. Single Event Effect Safe Operating Area**

| Ion | LET MeV/(mg/cm <sup>2</sup> ) | Energy (MeV) | Range (μm) | VDS(V)  |         |          |          |          |
|-----|-------------------------------|--------------|------------|---------|---------|----------|----------|----------|
|     |                               |              |            | @VGS=0V | @VGS=5V | @VGS=10V | @VGS=15V | @VGS=20V |
| Cu  | 28                            | 285          | 43         | -100    | -100    | -100     | -70      | -60      |
| Br  | 36.8                          | 305          | 39         | -100    | -100    | -70      | -50      | -40      |
| I   | 59.9                          | 345          | 32.8       | -60     | —       | —        | —        | —        |

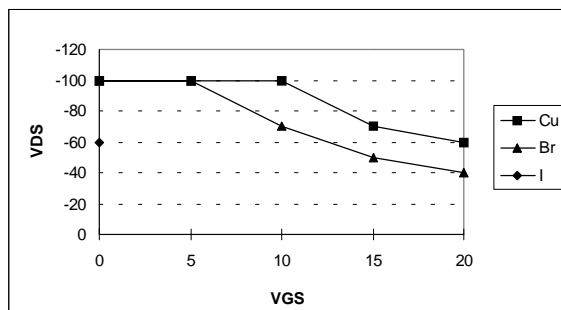

**Fig a. Single Event Effect, Safe Operating Area**

For footnotes refer to the last page

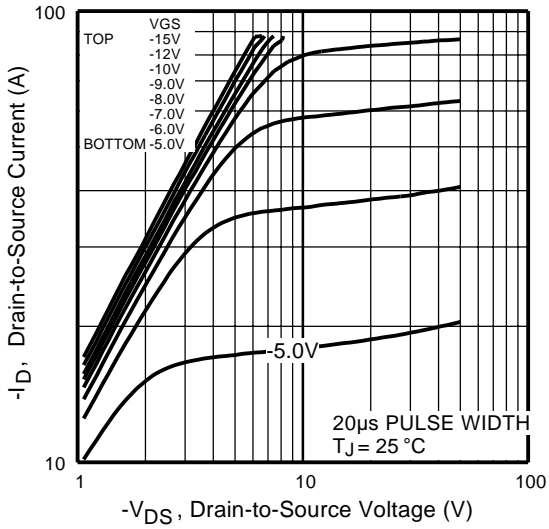

Fig1. Typical Output Characteristics

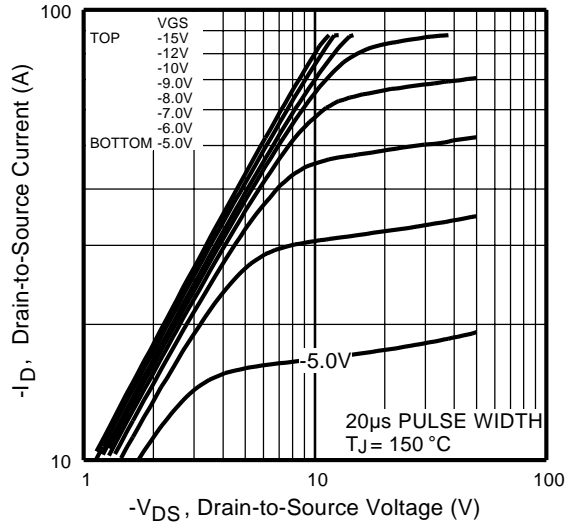

Fig2. Typical Output Characteristics

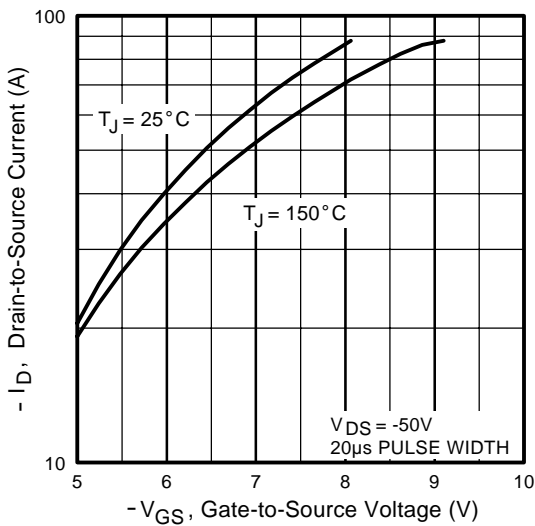

Fig3. Typical Transfer Characteristics

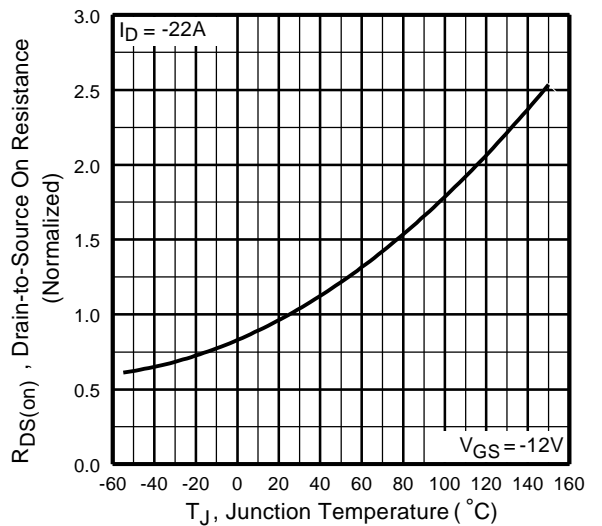
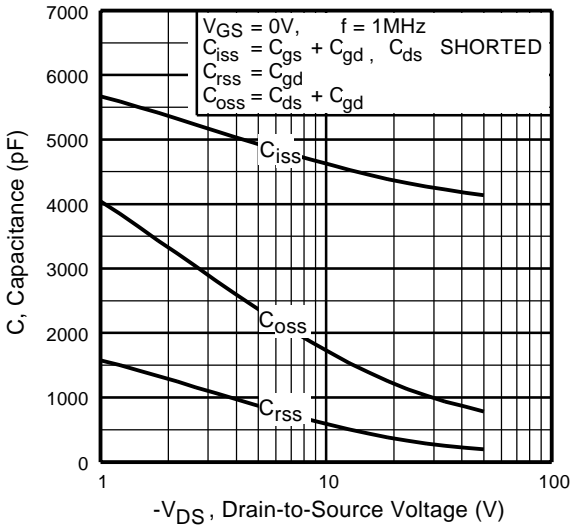
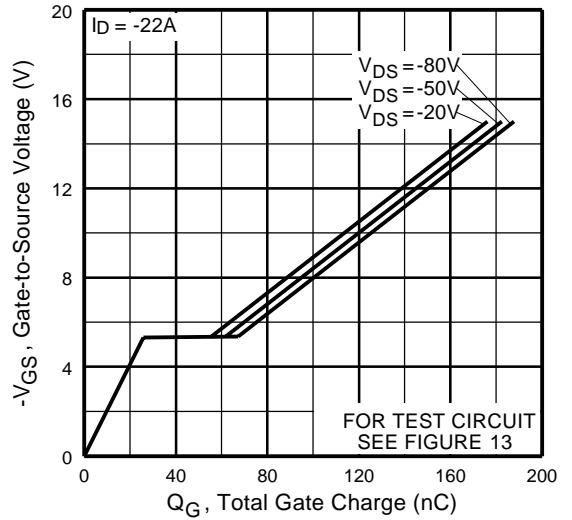

Fig4. Normalized On-Resistance Vs. Temperature



**Fig5.** Typical Capacitance Vs. Drain-to-Source Voltage



**Fig6.** Typical Gate Charge Vs. Gate-to-Source Voltage

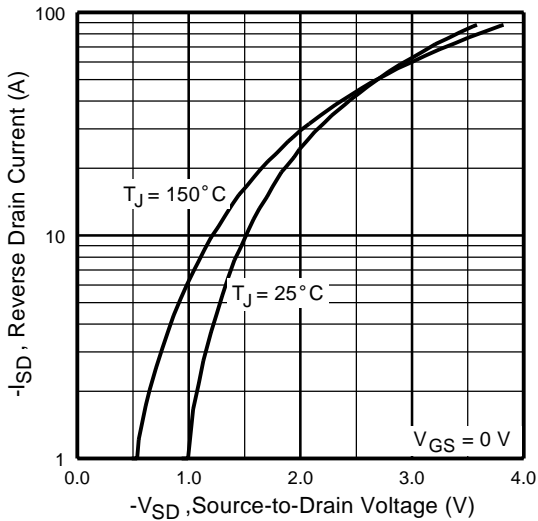

**Fig7.** Typical Source-Drain Diode Forward Voltage

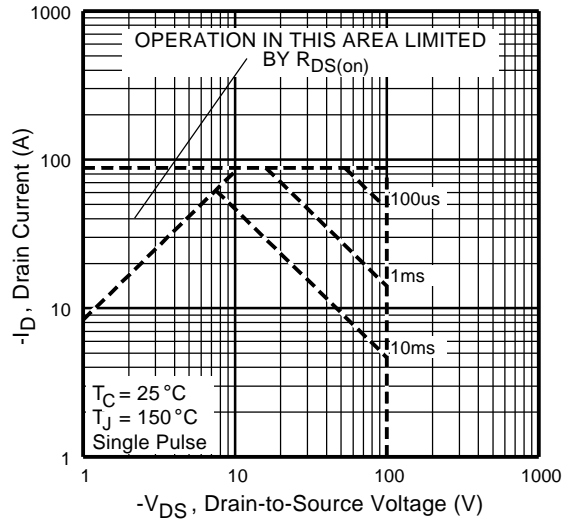

**Fig8.** Maximum Safe Operating Area

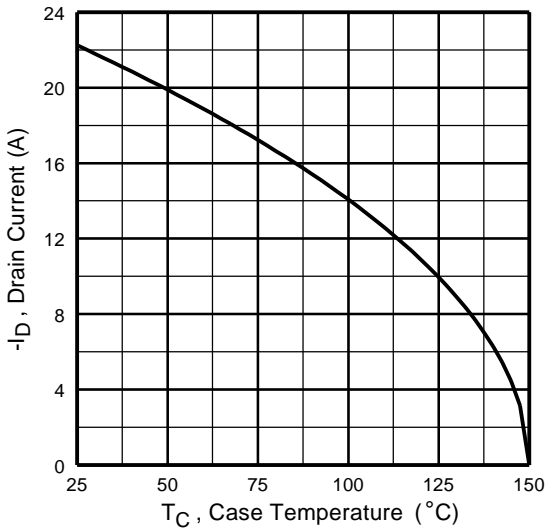

**Fig9.** Maximum Drain Current Vs. Case Temperature

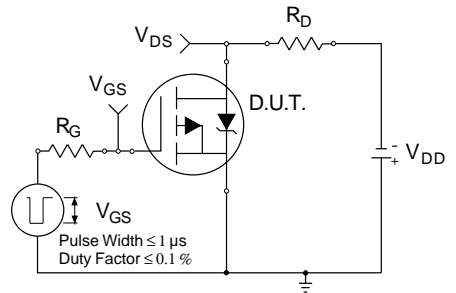

**Fig10a.** Switching Time Test Circuit

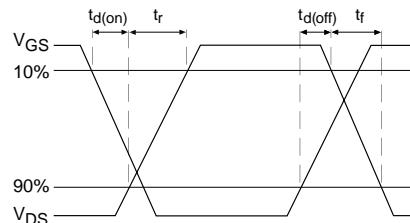

**Fig10b.** Switching Time Waveforms

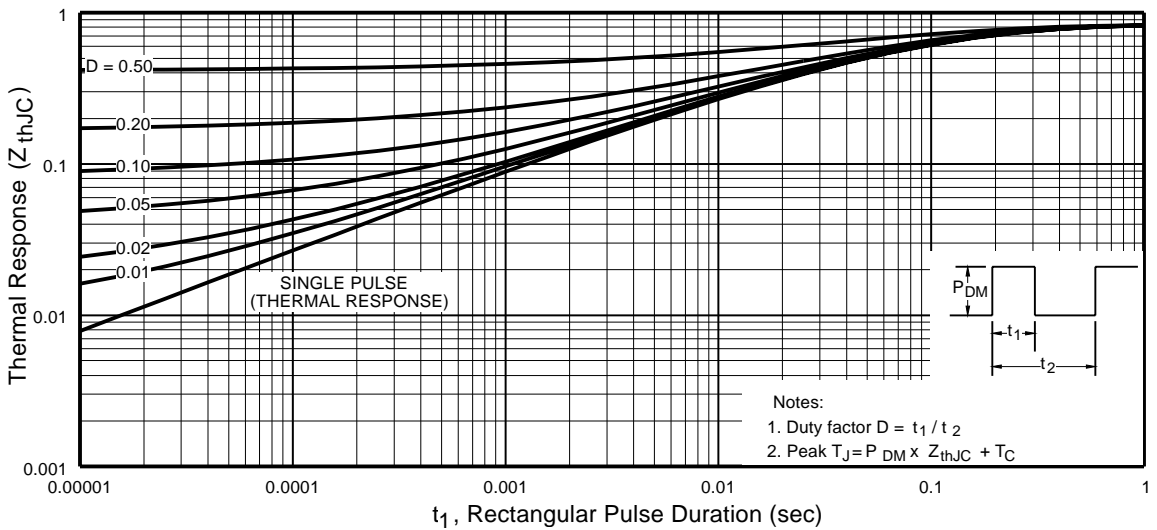

**Fig11.** Maximum Effective Transient Thermal Impedance, Junction-to-Case

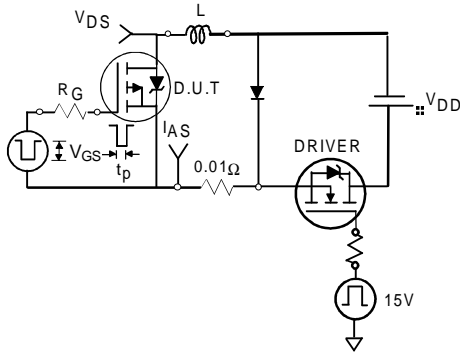

Fig 12a. Unclamped Inductive Test Circuit

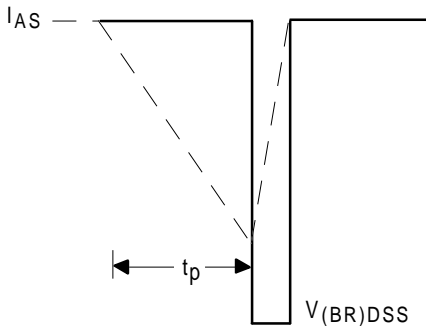

Fig 12b. Unclamped Inductive Waveforms

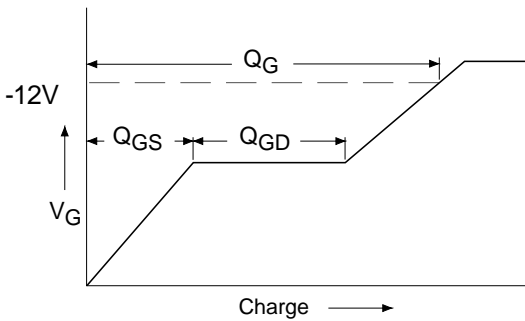

Fig 13a. Basic Gate Charge Waveform

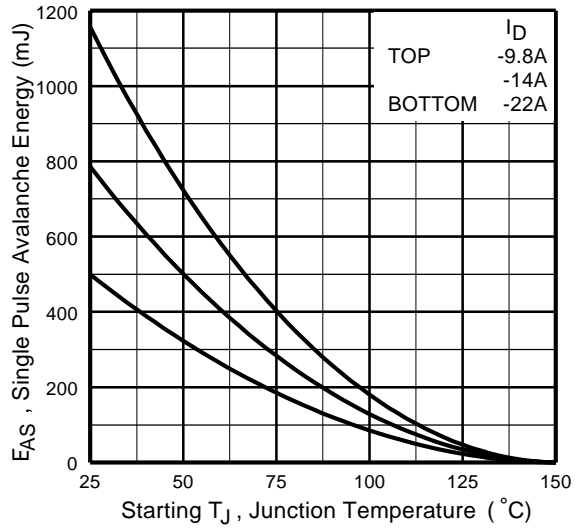

Fig 12c. Maximum Avalanche Energy Vs. Drain Current

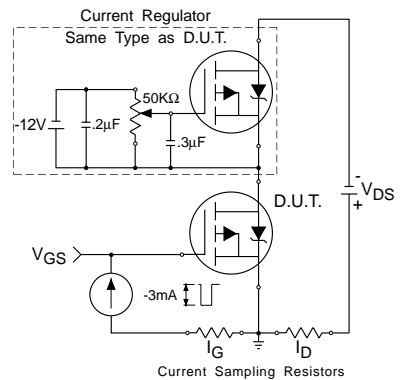
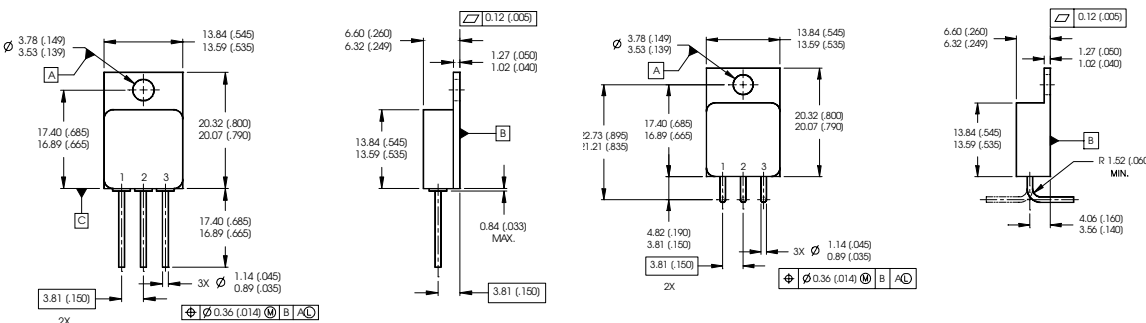

Fig 13b. Gate Charge Test Circuit

**Foot Notes:**

- ① Repetitive Rating; Pulse width limited by maximum junction temperature.
- ②  $V_{DD} = -25V$ , starting  $T_J = 25^{\circ}C$ ,  $L=2.1mH$   
Peak  $I_L = -22A$ ,  $V_{GS} = -12V$
- ③  $I_{SD} \leq -22A$ ,  $di/dt \leq -450A/\mu s$ ,  
 $V_{DD} \leq -100V$ ,  $T_J \leq 150^{\circ}C$
- ④ Pulse width  $\leq 300 \mu s$ ; Duty Cycle  $\leq 2\%$
- ⑤ **Total Dose Irradiation with  $V_{GS}$  Bias.**  
12 volt  $V_{GS}$  applied and  $V_{DS} = 0$  during irradiation per MIL-STD-750, method 1019, condition A.
- ⑥ **Total Dose Irradiation with  $V_{DS}$  Bias.**  
-80 volt  $V_{DS}$  applied and  $V_{GS} = 0$  during irradiation per MIL-STD-750, method 1019, condition A.

**Case Outline and Dimensions — TO-254AA**



NOTES:  
 1. DIMENSIONING & TOLERANCING PER ASME Y14.5M-1994.  
 2. ALL DIMENSIONS ARE SHOWN IN MILLIMETERS (INCHES).  
 3. CONTROLLING DIMENSION: INCH.  
 4. CONFORMS TO JEDEC OUTLINE TO-254AA.

PIN ASSIGNMENTS  
 1 = DRAIN  
 2 = SOURCE  
 3 = GATE

**CAUTION**

**BERYLLIA WARNING PER MIL-PRF-19500**

Packages containing beryllia shall not be ground, sandblasted, machined or have other operations performed on them which will produce beryllia or beryllium dust. Furthermore, beryllium oxide packages shall not be placed in acids that will produce fumes containing beryllium.



IR WORLD HEADQUARTERS: 233 Kansas St., El Segundo, California 90245, USA Tel: (310) 252-7105  
 TAC Fax: (310) 252-7903

Visit us at [www.irf.com](http://www.irf.com) for sales contact information.  
 Data and specifications subject to change without notice. 12/01