

GaAs MMIC HIGH ISOLATION SMT SPDT SWITCH, DC - 6.0 GHz

Typical Applications

The HMC232G8 is ideal for:

- Telecom Infrastructure
- Microwave Radio & VSAT
- Military Radios, Radar & ECM
- Space Systems
- Test Instrumentation

Functional Diagram

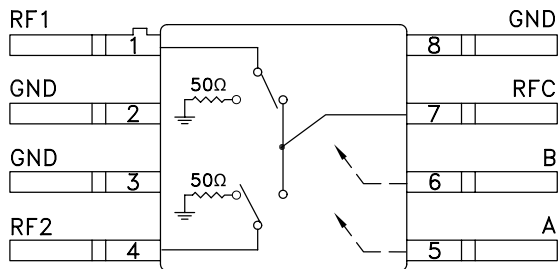

Features

- Isolation: 48 dB @ 2.0 GHz
34 dB @ 6.0 GHz
- Insertion Loss: 1.5 dB Typical @ 4.0 GHz
- Non-Reflective Design
- Hermetic Surface Mount Package

General Description

The HMC232G8 is a broadband high isolation non-reflective GaAs MESFET SPDT switch in a hermetic surface mount package. Covering DC to 6.0 GHz, the switch features >48 dB isolation up to 2 GHz and >34 dB isolation up to 6.0 GHz. The switch operates using complementary negative control voltage logic lines of -5/0V and requires no bias supply.

Electrical Specifications, $T_A = +25^\circ\text{C}$, With 0/-5V Control, 50 Ohm System

Parameter	Frequency	Min.	Typ.	Max.	Units
Insertion Loss	DC - 2.0 GHz		1.4	1.7	dB
	DC - 4.0 GHz		1.5	1.8	dB
	DC - 6.0 GHz		1.8	2.2	dB
Isolation	DC - 2.0 GHz	43	48		dB
	DC - 4.0 GHz	33	38		dB
	DC - 6.0 GHz	29	34		dB
Return Loss	"On State"	DC - 6.0 GHz	16		dB
Return Loss RF1, RF2	"Off State"	DC - 2.0 GHz	11		dB
	DC - 4.0 GHz	9			dB
	DC - 6.0 GHz	8			dB
Input Power for 1 dB Compression	0.5 - 6.0 GHz	22	27		dBm
Input Third Order Intercept (Two-Tone Input Power= +7 dBm Each Tone, 1 MHz Tone Separation)	0.5 - 6.0 GHz		46		dBm
Switching Characteristics	DC - 6.0 GHz	tRISE, tFALL (10/90% RF)	3		ns
		tON, tOFF (50% CTL to 10/90% RF)	6		ns

GaAs MMIC HIGH ISOLATION SMT SPDT SWITCH, DC - 6.0 GHz

Insertion Loss

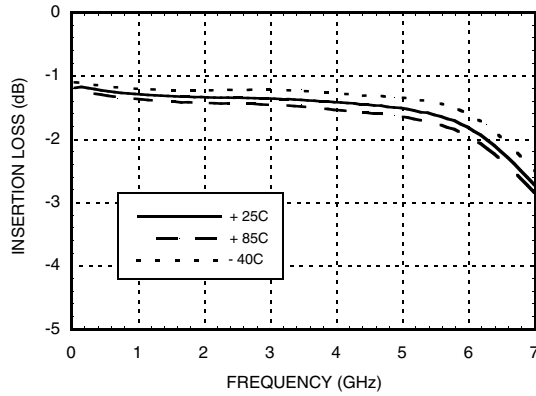

Isolation

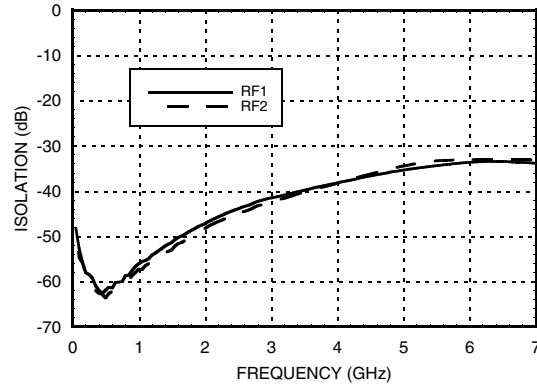

Return Loss

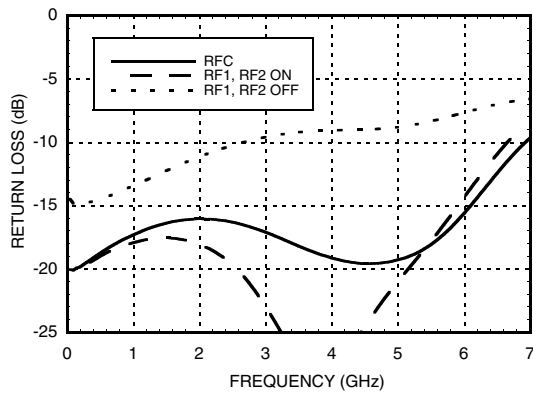

0.1 and 1 dB Input Compression Point

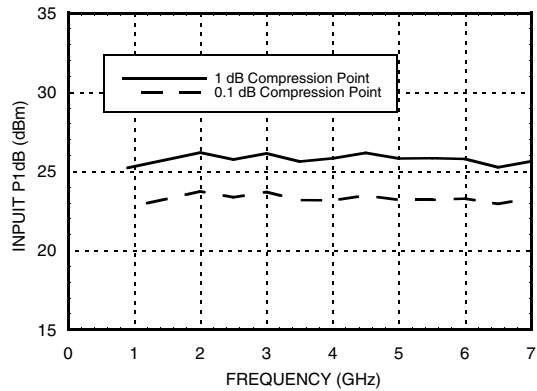

Input Third Order Intercept Point

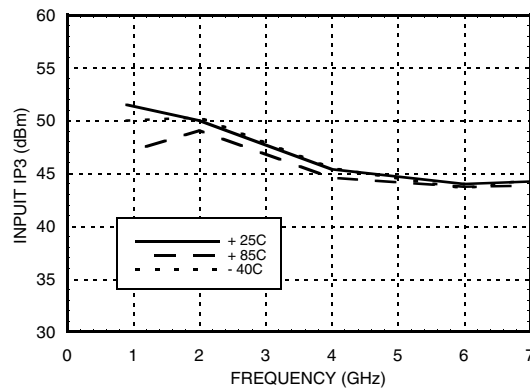

GaAs MMIC HIGH ISOLATION SMT SPDT SWITCH, DC - 6.0 GHz

Control Voltages

State	Bias Condition
Low	0 to -0.2V @ 10 uA Max.
High	-5V @ 10 uA Typ. to -7V @ 45 uA Typ.

Truth Table

Control Input		Signal Path State	
A	B	RFC to RF1	RFC to RF2
High	Low	ON	OFF
Low	High	OFF	ON

Absolute Maximum Ratings

RF Input Power (Vctl= -5V) (0.5 - 6 GHz)	+30 dBm (@ +50 °C)
Control Voltage Range (A & B)	+1.0V to -7.5 Vdc
Channel Temperature	150 °C
Thermal Resistance (R _{TH}) (junction to lead)	94 °C/W
Storage Temperature	-65 to +150 °C
Operating Temperature	-40 to +85 °C

Caution: Do not "Hot Switch" power levels greater than +27 dBm (Vctl = 0/-5 Vdc).

Outline Drawing

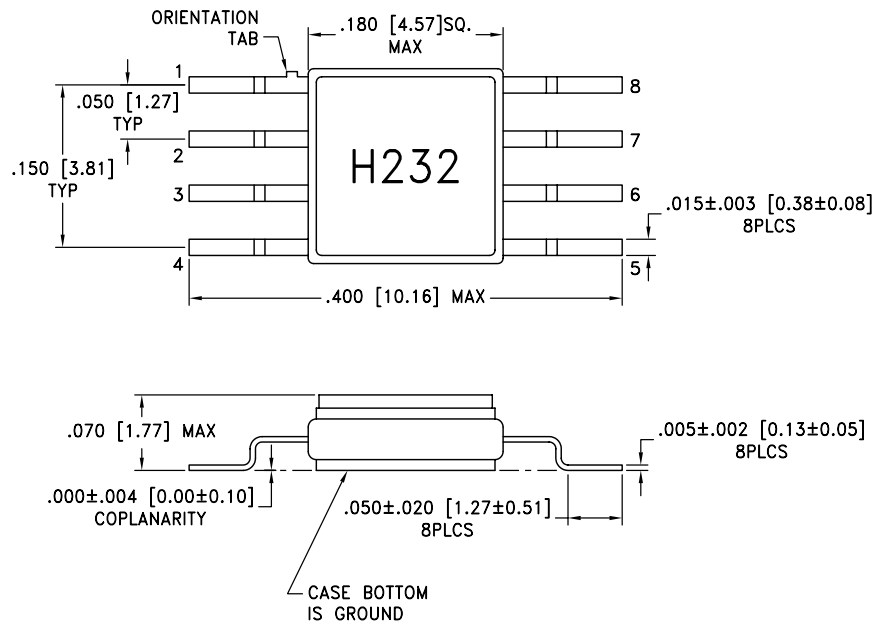

NOTES:

1. PACKAGE MATERIAL: ALUMINA LOADED BOROSILICATE GLASS.
2. LEADS, BASE, COVER MATERIAL: KOVART™ (#7052 CORNING).
3. PLATING: ELECTROLYTIC GOLD 50 MICROINCHES MIN., OVER ELECTROLYTIC NICKEL 50 MICROINCHES MIN.
4. ALL DIMENSIONS ARE IN INCHES [MILLIMETERS].
5. TOLERANCES: .±.005 [0.13] UNLESS OTHERWISE SPECIFIED.
6. ALL GROUND LEADS AND GROUND PADDLE MUST BE SOLDERED TO PCB RF GROUND.

For price, delivery, and to place orders, please contact Hittite Microwave Corporation:
12 Elizabeth Drive, Chelmsford, MA 01824 Phone: 978-250-3343 Fax: 978-250-3373
Order Online at www.hittite.com

GaAs MMIC HIGH ISOLATION SMT SPDT SWITCH, DC - 6.0 GHz

Suggested Driver Circuit

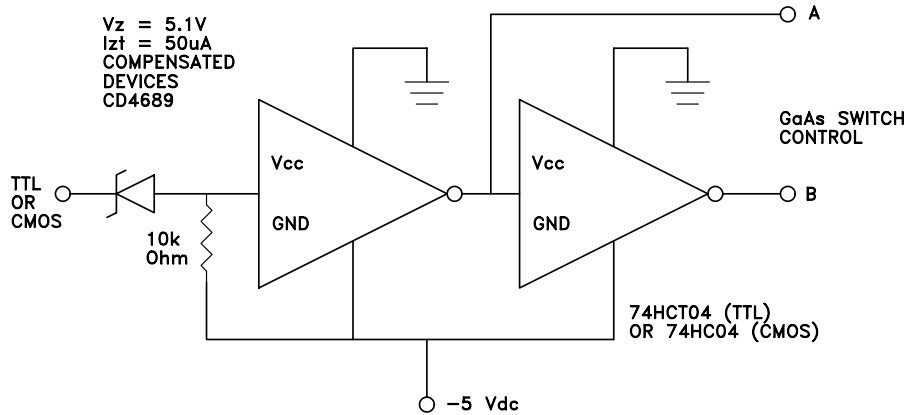

Pin Descriptions

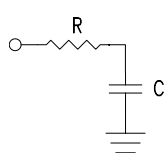
Pin Number	Function	Description	Interface Schematic
1, 4, 7	RF1, RF2, RFC	This pin is DC coupled and matched to 50 Ohm. Blocking capacitors are required if RF line potential is not equal to 0V.	
2, 3, 8	GND	Package bottom must also be connected to PCB RF ground.	
5	A	See truth table and control voltage table.	
6	B	See truth table and control voltage table.	

GaAs MMIC HIGH ISOLATION SMT SPDT SWITCH, DC - 6.0 GHz

Evaluation PCB

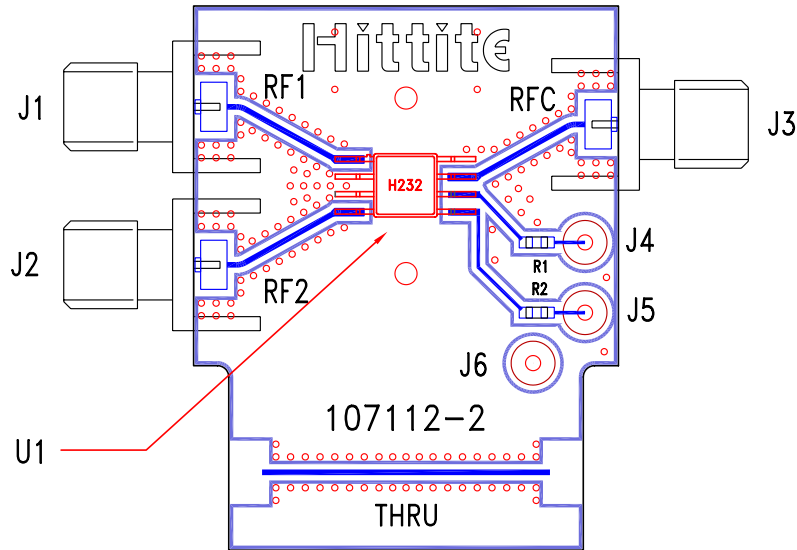

List of Material

Item	Description
J1 - J3	PC Mount SMA RF Connector
J4 - J6	DC Pin
R1, R2	100 Ohm Resistor, 0603 Pkg.
U1	HMC232G8 SPDT Switch
PCB*	107112 Evaluation PCB
* Circuit Board Material: Rogers 4350	

The circuit board used in the final application should be generated with proper RF circuit design techniques. Signal lines at the RF port should have 50 ohm impedance and the package ground leads and package bottom should be connected directly to the ground plane similar to that shown above. The evaluation circuit board shown above is available from Hittite Microwave Corporation upon request.

GaAs MMIC HIGH ISOLATION SMT SPDT SWITCH, DC - 6.0 GHz

Notes: