

# FS16VS-6

HIGH-SPEED SWITCHING USE

**FS16VS-6**



- V<sub>DSS</sub> ..... 300V
- r<sub>DS (ON)</sub> (MAX) ..... 0.33Ω
- I<sub>D</sub> ..... 16A

**OUTLINE DRAWING** Dimensions in mm

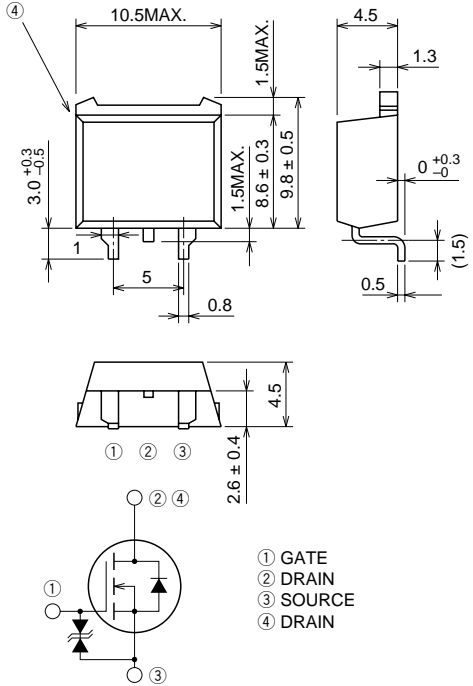

① GATE  
② DRAIN  
③ SOURCE  
④ DRAIN

**TO-220S**

## APPLICATION

SMPS, DC-DC Converter, battery charger, power supply of printer, copier, HDD, FDD, TV, VCR, personal computer etc.

## MAXIMUM RATINGS (T<sub>c</sub> = 25°C)

| Symbol           | Parameter                 | Conditions           | Ratings    | Unit |
|------------------|---------------------------|----------------------|------------|------|
| V <sub>DSS</sub> | Drain-source voltage      | V <sub>GS</sub> = 0V | 300        | V    |
| V <sub>GSS</sub> | Gate-source voltage       | V <sub>DS</sub> = 0V | ±30        | V    |
| I <sub>D</sub>   | Drain current             |                      | 16         | A    |
| I <sub>DM</sub>  | Drain current (Pulsed)    |                      | 48         | A    |
| P <sub>D</sub>   | Maximum power dissipation |                      | 125        | W    |
| T <sub>ch</sub>  | Channel temperature       |                      | -55 ~ +150 | °C   |
| T <sub>stg</sub> | Storage temperature       |                      | -55 ~ +150 | °C   |
| —                | Weight                    | Typical value        | 1.2        | g    |

**ELECTRICAL CHARACTERISTICS** (T<sub>ch</sub> = 25°C)

| Symbol                 | Parameter                        | Test conditions  | Limits                                    |      |      | Unit |
|------------------------|----------------------------------|--|---|------|------|------|
|                        |                                  |  | Min.                                      | Typ. | Max. |      |
| V (BR) DSS             | Drain-source breakdown voltage   | I <sub>D</sub> = 1mA, V <sub>GS</sub> = 0V   | 300                                       | —    | —    | V    |
| V (BR) GSS             | Gate-source breakdown voltage    | I <sub>G</sub> = ±100μA, V <sub>DS</sub> = 0V  | ±30                                       | —    | —    | V    |
| I <sub>GSS</sub>       | Gate-source leakage current      | V <sub>GS</sub> = ±25V, V <sub>DS</sub> = 0V   | —   | —    | ±10  | μA   |
| I <sub>DSS</sub>       | Drain-source leakage current     | V <sub>DS</sub> = 300V, V <sub>GS</sub> = 0V   | —   | —    | 1    | mA   |
| V <sub>GS</sub> (th)   | Gate-source threshold voltage    | I <sub>D</sub> = 1mA, V <sub>DS</sub> = 10V  | 2   | 3    | 4    | V    |
| r <sub>DS</sub> (ON)   | Drain-source on-state resistance | I <sub>D</sub> = 8A, V <sub>GS</sub> = 10V   | —   | 0.25 | 0.33 | Ω    |
| V <sub>DS</sub> (ON)   | Drain-source on-state voltage    | I <sub>D</sub> = 8A, V <sub>GS</sub> = 10V   | —   | 2.0  | 2.64 | V    |
| y <sub>fs</sub>        | Forward transfer admittance      | I <sub>D</sub> = 8A, V <sub>DS</sub> = 10V   | 6.5                                       | 10.0 | —    | S    |
| C <sub>iss</sub>       | Input capacitance                | V <sub>DS</sub> = 25V, V <sub>GS</sub> = 0V, f = 1MHz  | —   | 1050 | —    | pF   |
| C <sub>oss</sub>       | Output capacitance               |  | —   | 220  | —    | pF   |
| C <sub>rss</sub>       | Reverse transfer capacitance     |  | —   | 45   | —    | pF   |
| t <sub>d</sub> (on)    | Turn-on delay time               |  | —   | 20   | —    | ns   |
| t <sub>r</sub>         | Rise time                        | V <sub>DD</sub> = 150V, I <sub>D</sub> = 8A, V <sub>GS</sub> = 10V, R <sub>GEN</sub> = R <sub>GS</sub> = 50Ω | —   | 40   | —    | ns   |
| t <sub>d</sub> (off)   | Turn-off delay time              |  | —   | 110  | —    | ns   |
| t <sub>f</sub>         | Fall time                        |  | —   | 50   | —    | ns   |
| V <sub>SD</sub>        | Source-drain voltage             |  | I <sub>S</sub> = 8A, V <sub>GS</sub> = 0V | —    | 1.5  | 2.0  |
| R <sub>th</sub> (ch-c) | Thermal resistance               | Channel to case  | —   | —    | 1.00 | °C/W |

**PERFORMANCE CURVES**

**POWER DISSIPATION DERATING CURVE**

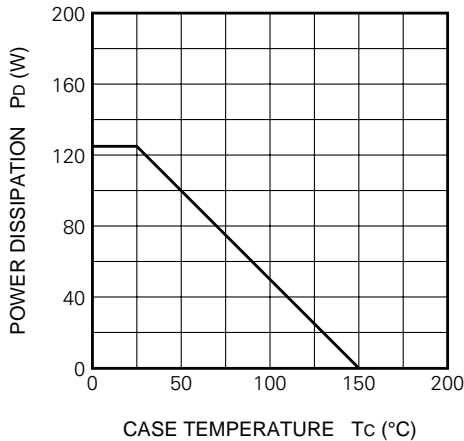

**MAXIMUM SAFE OPERATING AREA**

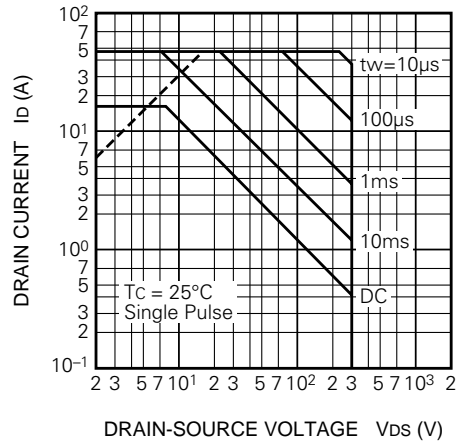

**OUTPUT CHARACTERISTICS (TYPICAL)**

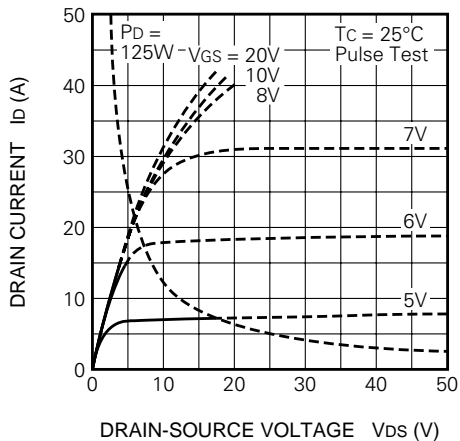

**OUTPUT CHARACTERISTICS (TYPICAL)**

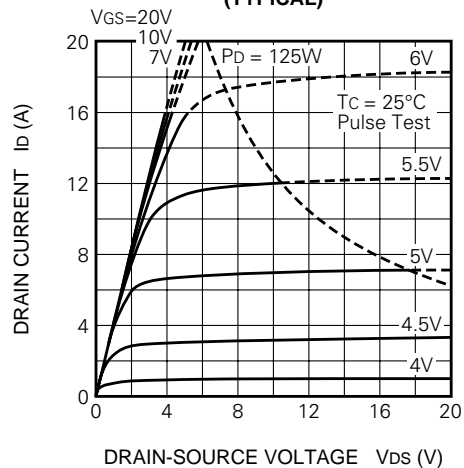

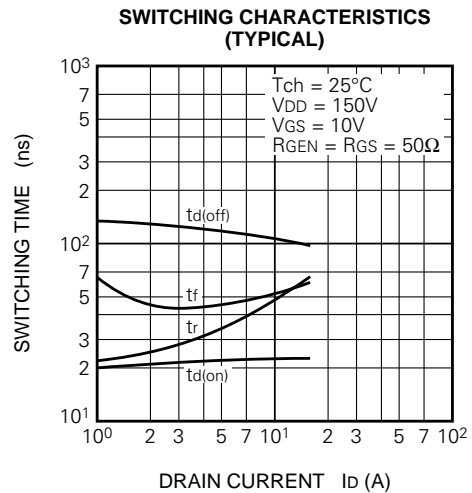
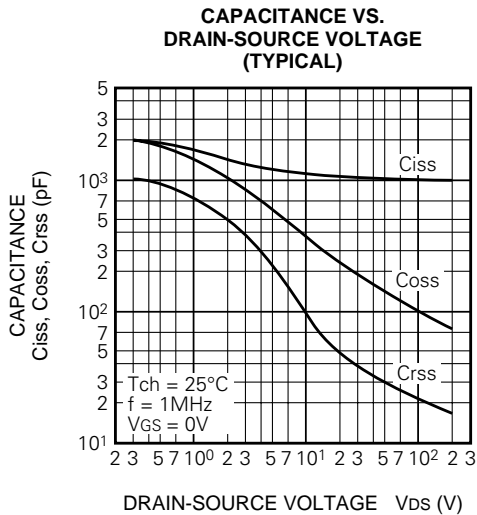
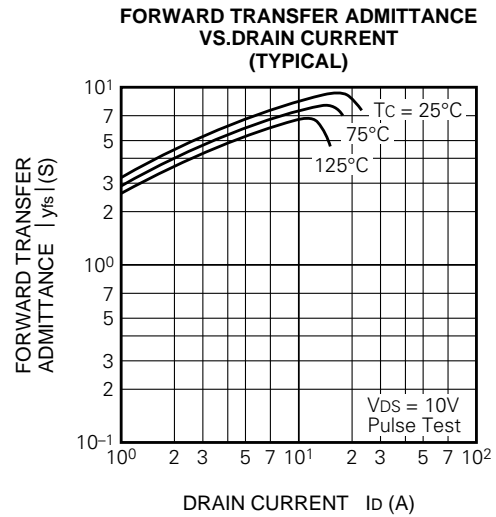
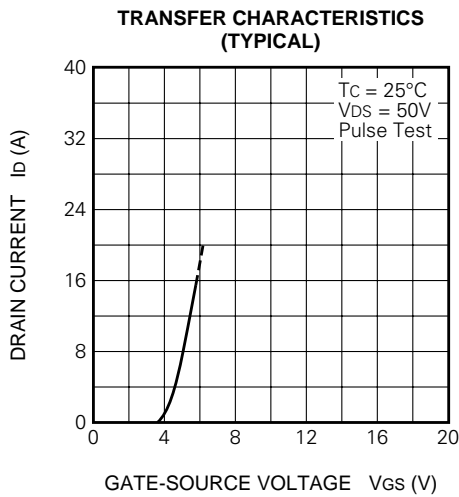
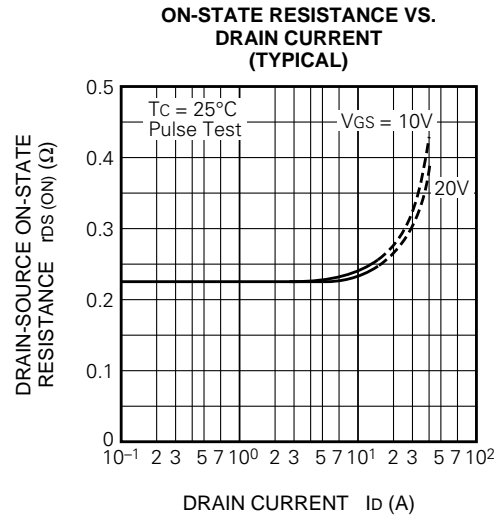
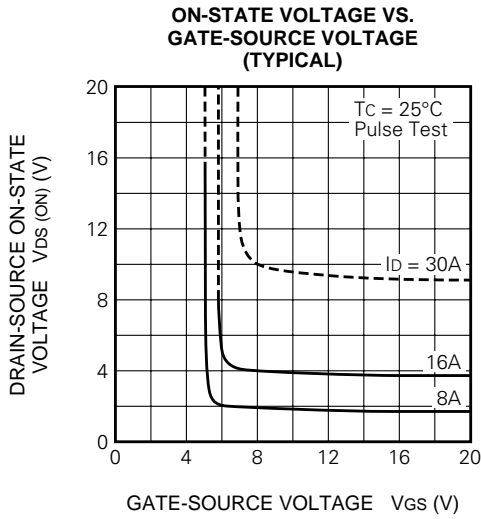

**GATE-SOURCE VOLTAGE VS. GATE CHARGE (TYPICAL)**

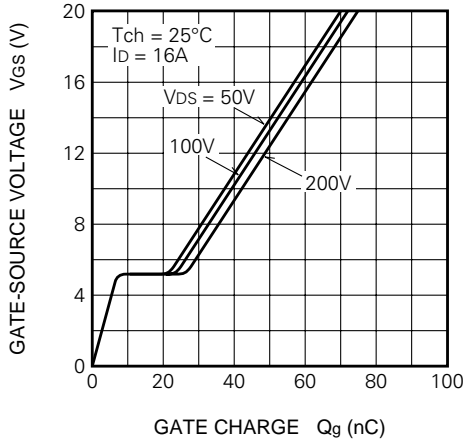

**SOURCE-DRAIN DIODE FORWARD CHARACTERISTICS (TYPICAL)**

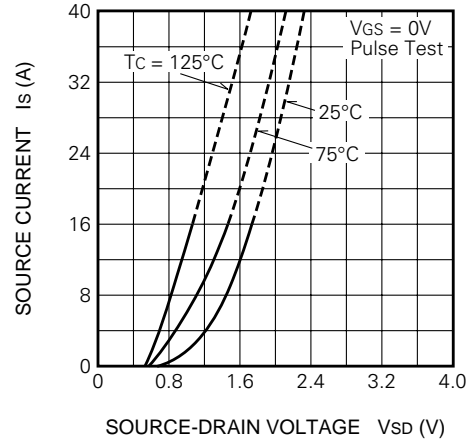

**ON-STATE RESISTANCE VS. CHANNEL TEMPERATURE (TYPICAL)**

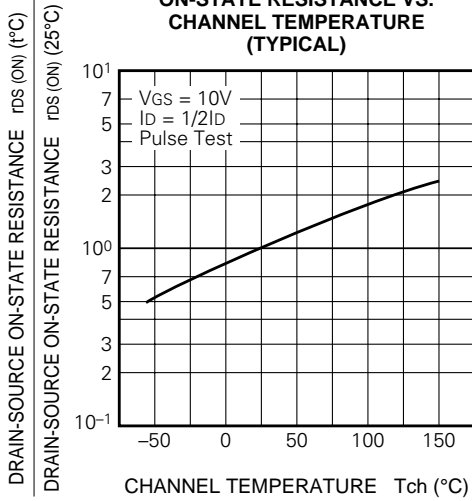

**THRESHOLD VOLTAGE VS. CHANNEL TEMPERATURE (TYPICAL)**

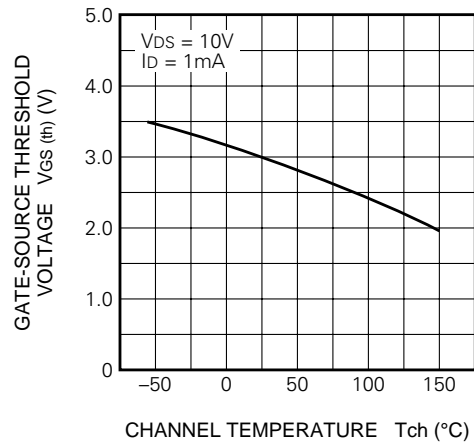

**BREAKDOWN VOLTAGE VS. CHANNEL TEMPERATURE (TYPICAL)**

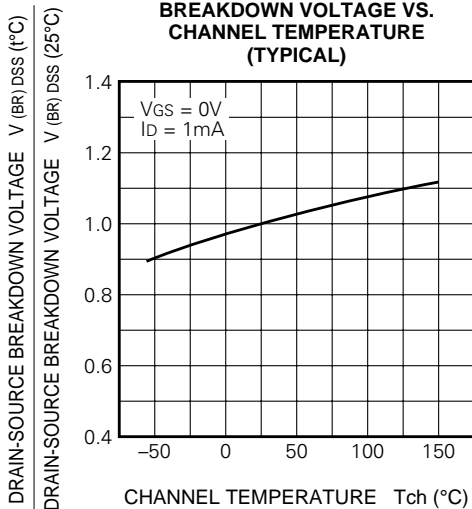

**TRANSIENT THERMAL IMPEDANCE CHARACTERISTICS**

