



# AKD4364

## Evaluation board Rev.A for AK4364

**GENERAL DESCRIPTION**

The AKD4364 is an evaluation board for AK4364, 96kHz 24bit D/A converter with PLL & DIT. The AKD4364 has a digital interface with AKM's wave generator using ROM data and AKM's A/D converter evaluation boards. Therefore, it is easy to evaluate the AK4364.

■ **Ordering guide**

AKD4364 --- Evaluation board for AK4364  
 (Cable for connecting with printer port of IBM-AT compatible PC and control software are packed with this.)

**FUNCTION**

- On-board clock generator
- Compatible with 2 types of interface
  - Direct interface with AKM's A/D converter evaluation boards and direct interface with AKM's signal generator(AKD43XX) by 10pin header
  - On-board CS8414 as DIR which accepts optical input
- BNC connector for external clock input
- 10pin header for serial control interface
- On-board mute circuit for analog output
- Optical output for TX output

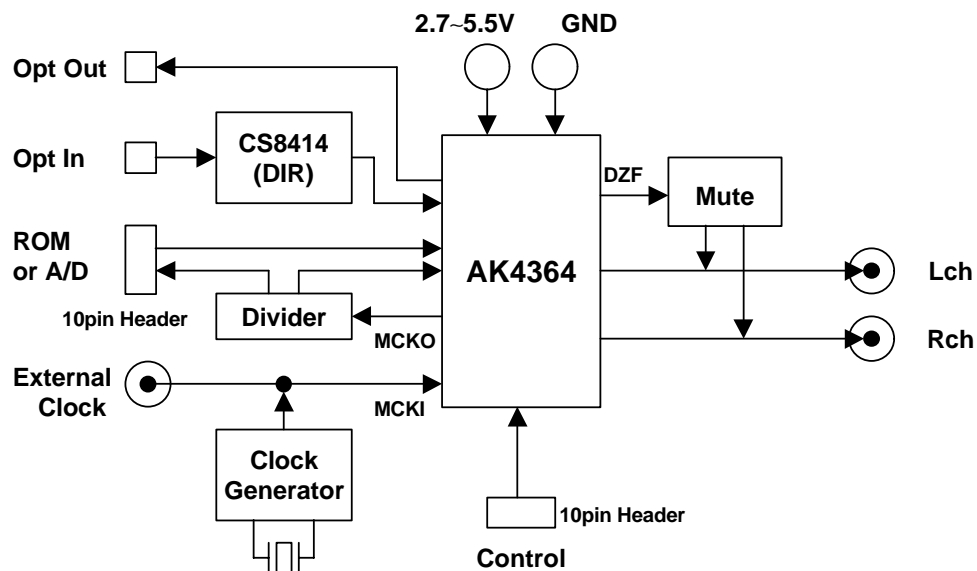

Figure 1. AKD4364 Block Diagram

\* Circuit diagram and PCB layout are attached at the end of this manual.

■ External analog circuit

J1(AOUTL) and J2(AOUTR) are used. The analog output signal range is nominally 3.1Vpp@5V. It is proportional to AVDD ( $V_{out}=0.62 \times AVDD$ ).

■ Operation sequence

1) Set up the power supply lines.

- [AVDD] (red) = 2.7~5.5V : for AVDD of AK4364
- [3V] (orange) = 2.7~5.5V : for DVDD of AK4364
- [5V] (red) = 3.4~5.5V : for logic
- [AGND] (black)= 0V : for analog ground (including AVSS and DVSS of AK4364)
- [DGND] (black)= 0V : for logic ground

Each supply line should be distributed from the power supply unit.

2) Set up the evaluation mode, jumper pins and DIP switches. (See the followings.)

3) Power on.

The AK4364 should be reset once bringing SW1(-PD) “L” upon power-up.

4) Connect PORT2 with PC.

Connect PORT2 with printer port (parallel port) of IBM-AT compatible PC by 10-line flat cable packed with the AKD4364. Take care of the direction of connector. There is a mark at 1pin. The direction of PORT2 is as the following figure.

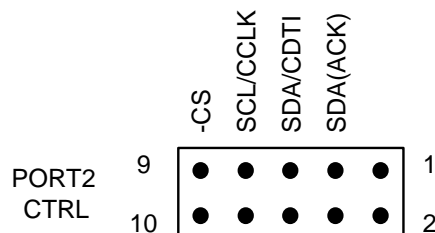

5) Set up the software.

Use the software named “AKD4364 Control Program” packed with the AKD4364.

■ Evaluation mode

1) Using A/D converted data <default>

PORT3 (ADC/ROM) is used to interface with various AKM’s A/D converter evaluation boards. In case of using external clock through a BNC connector (J4), select BNC on JP14 (CLK) and short JP15 (XTE).

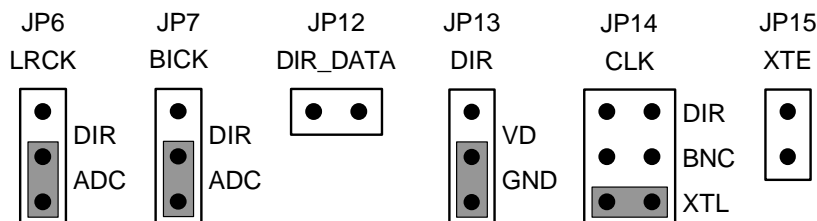

2) Ideal sine wave generated by ROM data

Digital signals generated by AKD43XX are used. PORT3 (ADC/ROM) is used to interface with AK43XX. Master clock is sent from AKD4364 to AKD43XX and LRCK, BICK, SDTI are supplied from AKD43XX to AKD4364. In case of using external clock through a BNC connector (J4), select “BNC” on JP14 (CLK) and short JP15 (XTE).

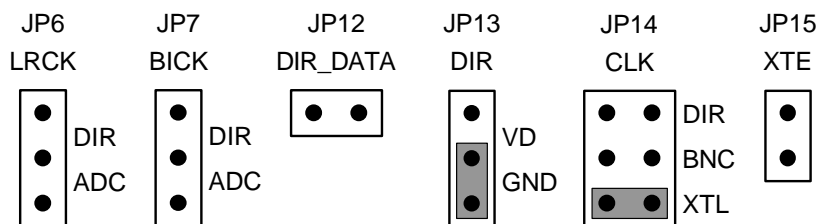

3) DIR(CS8414)

PORT4 (TORX174) is used for the evaluation using such as test disk. The DIR generates MCKI, BICK, LRCK, SDTI from the received data through optical connector. In this case, the EXT bit of AK4364 should be “1” (External clock mode). Select “RCA” or “OPT” on JP16 (RCA/OPT) in case of using RCA connector (J3) or optical connector (PORT4: TORX174).



■ Clock (MCLK,BICK,LRCK) set up

In case of using evaluation mode 1), JP9,10 and 17 should be set up as follows. They need no care for other evaluation mode.

| MCLK   | JP9<br>(X_MCLK) | JP10<br>(X_LRCK) | BICK                  | JP17<br>(X_BICK)     |         |
|--------|-----------------|------------------|-----------------------|----------------------|---------|
| 128fs  | x1              | x1/128           | 32fs<br>64fs<br>128fs | x1/4<br>x1/2<br>x1   | default |
| 256fs  | x1              | x1/256           | 32fs<br>64fs<br>128fs | x1/8<br>x1/4<br>x1/2 |         |
| 512fs  | x2              | x1/256           | 32fs<br>64fs<br>128fs | x1/8<br>x1/4<br>x1/2 |         |
| 1024fs | x4              | x1/256           | 32fs<br>64fs<br>128fs | x1/8<br>x1/4<br>x1/2 |         |

Table 1. Clock set up

## ■ DIP switch (SW2) set up

No.1 to 5 set the mode of AK4364 and No.6 to 8 set the mode of CS8414.

| No. | Pin  | OFF <default>  | ON        |
|-----|------|--|-----------|
| 1   | CAD1 | Chip address (2bit)  |           |
| 2   | CAD0 |  |           |
| 3   | I2C  | 3-wire serial  | I2C bus   |
| 4   | TTL  | CMOS level   | TTL level |
| 5   | TST  | always "OFF"   | -         |
| 6   | M2   | Digital interface format of CS8414<br>(See table 3.)<br>(Note) |           |
| 7   | M1   |  |           |
| 8   | M0   |  |           |

Table 2. DIP switch set-up

(Note: M2-0 should be selected at only evaluation mode 3.  
In other mode, these should be "OFF".)

| Mode | Format               | M2 | M1 | M0 | JP9 | DIF2 | DIF1 | DIF0 |
|------|----------------------|----|----|----|-----|------|------|------|
| 0    | 16bit, LSB justified | 1  | 0  | 1  | THR | 0    | 0    | 0    |
| 1    | 18bit, LSB justified | 1  | 1  | 0  | THR | 0    | 0    | 1    |
| 2    | 20bit, LSB justified | -  | -  | -  | -   | 0    | 1    | 0    |
| 3    | 24bit, LSB justified | -  | -  | -  | -   | 0    | 1    | 1    |
| 4    | 24bit, MSB justified | 0  | 0  | 0  | INV | 1    | 0    | 0    |
| 5    | I2S                  | 0  | 1  | 0  | THR | 1    | 0    | 1    |

Table 3. Digital interface format set-up

(Note: 1="ON", 0="OFF".

DIF2-0 should be selected by serial control.

CS8414 does not correspond to 20/24bit LSB justified format.)

## ■ Serial control mode

The AK4364 can be controlled via the printer port (parallel port) of IBM-AT compatible PC. Connect PORT2 (CTRL) with PC by 10-line flat cable packed with the AKD4364.

There are two modes: 3-wire serial & I2C bus. JP4 should be shorted at 3-wire serial control mode.

Chip address can be selected by SW2(MODE)-No.1(CAD1) and No.2(CAD0).

## ■ Other jumper pins set up

[JP1](GND): Analog ground and digital ground

Open: Separated <default>

Short: Common (The connector "DGND" can be open.)

[JP2](5V-3V): DVDD of AK4364 and power supply to logic

Open: Independent <default>

Short: Same (The connector "3V" should be open.)

[JP3](DVDD): DVDD of AK4364

3V: Independent of AVDD <default>

AVDD: Same as AVDD (The connector "3V" can be open.)

[JP5](DZF): Mute circuit

ON: Used (Analog output is muted when DZF="H".) <default>

OFF: Not used

[JP11](SDTI): SDTI of AK4364

DATA: Data is input <default>

GND: "0" data is input

#### ■ The function of the toggle SW (SW1)

Upper-side is "H" and lower-side is "L".

[SW1] (-PD): Resets the AK4364. Keep "H" during normal operation.

#### ■ The indication content for LED

[LED1] (VERF): Monitors VERF pin of the CS8414. LED turns on when some error has occurred to CS8414.

[LED2] (PREM): Indicates whether the input data is pre-emphasis or not.

LED turns on when the data is pre-emphasised.

|                            |
|----------------------------|
| <b>MEASUREMENT RESULTS</b> |
|----------------------------|

## [Measurement condition]

- Measurement unit : ROHDE & SCHWARZ, UPD04
- MCLK : 256fs
- BICK : 64fs
- fs : 44.1kHz, 96kHz
- BW : 20Hz~20kHz (fs=44.1kHz), 20Hz~40kHz (fs=96kHz)
- Bit : 24bit
- Power Supply : AVDD=DVDD=5V
- Interface : DIR (EXT mode, fs=44.1kHz), Serial Multiplex (EXT mode, fs=96kHz; PLL mode)
- Temperature : Room

fs=44.1kHz

| Parameter | Input signal | Measurement filter | EXT     | PLL     |
|-----------|--------------|--------------------|---------|---------|
| S/(N+D)   | 1kHz, 0dB    | 20kLPF             | 97.0dB  | 88.9dB  |
| DR        | 1kHz, -60dB  | 20kLPF             | 99.0dB  | 98.4dB  |
|           |              | 20kLPF, A-weighted | 102.3dB | 101.9dB |
| S/N       | no signal    | 20kLPF             | 99.0dB  | 98.4dB  |
|           |              | 20kLPF, A-weighted | 102.3dB | 101.9dB |

fs=96kHz

| Parameter | Input signal | Measurement filter | EXT     | PLL     |
|-----------|--------------|--------------------|---------|---------|
| S/(N+D)   | 1kHz, 0dB    | 40kLPF             | 92.5dB  | 84.9dB  |
| DR        | 1kHz, -60dB  | 40kLPF             | 97.0dB  | 95.9dB  |
|           |              | 20kLPF, A-weighted | 101.5dB | 101.9dB |
| S/N       | no signal    | 40kLPF             | 97.0dB  | 95.9dB  |
|           |              | 20kLPF, A-weighted | 101.5dB | 101.9dB |

## [Measurement condition]

- Measurement unit : Audio Precision, System two, Cascade
- MCLK : 256fs
- BICK : 64fs
- fs : 44.1kHz, 96kHz
- BW : 10Hz~20kHz (fs=44.1kHz), 10Hz~40kHz (fs=96kHz)
- Bit : 24bit
- Power Supply : AVDD=DVDD=5V
- Interface : DIR
- Temperature : Room

fs=44.1kHz

| Parameter | Input signal | Measurement filter | EXT     |
|-----------|--------------|--------------------|---------|
| S/(N+D)   | 1kHz, 0dB    | 20kLPF             | 97.4dB  |
| DR        | 1kHz, -60dB  | 20kLPF             | 98.8dB  |
|           |              | 22kLPF, A-weighted | 101.6dB |
| S/N       | no signal    | 20kLPF             | 98.6dB  |
|           |              | 22kLPF, A-weighted | 101.8dB |

fs=96kHz

| Parameter | Input signal | Measurement filter | EXT     |
|-----------|--------------|--------------------|---------|
| S/(N+D)   | 1kHz, 0dB    | 40kLPF             | 94.5dB  |
| DR        | 1kHz, -60dB  | 40kLPF             | 96.9dB  |
|           |              | 22kLPF, A-weighted | 101.9dB |
| S/N       | no signal    | 40kLPF             | 96.8dB  |
|           |              | 22kLPF, A-weighted | 101.9dB |

|              |
|--------------|
| <b>PLOTS</b> |
|--------------|

## [Measurement condition]

- Measurement unit : ROHDE & SCHWARZ, UPD04 (for PLL mode),  
Audio Precision, System two (for EXT mode)
- MCLK : 256fs
- BICK : 64fs
- fs : 44.1kHz, 96kHz
- Bit : 24bit
- Power Supply : AVDD=DVDD=5V
- Interface : Serial Multiplexer (for PLL mode), DIR (for EXT mode)
- Temperature : Room

## [Contents]

## 1. PLL mode

## 1-1. fs=44.1kHz

- Figure 1-1-1. THD+N vs. Input level
- Figure 1-1-2. THD+N vs. Input frequency
- Figure 1-1-3. Linearity
- Figure 1-1-4. Frequency response
- Figure 1-1-5. Cross-talk
- Figure 1-1-6. FFT (1kHz, 0dBFS)
- Figure 1-1-7. FFT (1kHz, -60dBFS)
- Figure 1-1-8. FFT (noise floor)
- Figure 1-1-9. FFT (out-of-band noise, ~300kHz)

## 1-2. fs=96kHz

- Figure 1-2-1. THD+N vs. Input level
- Figure 1-2-2. THD+N vs. Input frequency
- Figure 1-2-3. Linearity
- Figure 1-2-4. Frequency response

## 2. EXT mode

## 2-1. fs=44.1kHz

- Figure 2-1-1. THD+N vs. Input level
- Figure 2-1-2. THD+N vs. Input frequency
- Figure 2-1-3. Linearity
- Figure 2-1-4. Frequency response
- Figure 2-1-5. Cross-talk
- Figure 2-1-6. FFT (1kHz, 0dBFS)
- Figure 2-1-7. FFT (1kHz, -60dBFS)
- Figure 2-1-8. FFT (noise floor)
- Figure 2-1-9. FFT (out-of-band noise, ~80kHz)

## 2-2. fs=96kHz

- Figure 2-2-1. THD+N vs. Input level
- Figure 2-2-2. THD+N vs. Input frequency
- Figure 2-2-3. Linearity
- Figure 2-2-4. Frequency response

1. PLL mode  
1-1. fs=44.1kHz

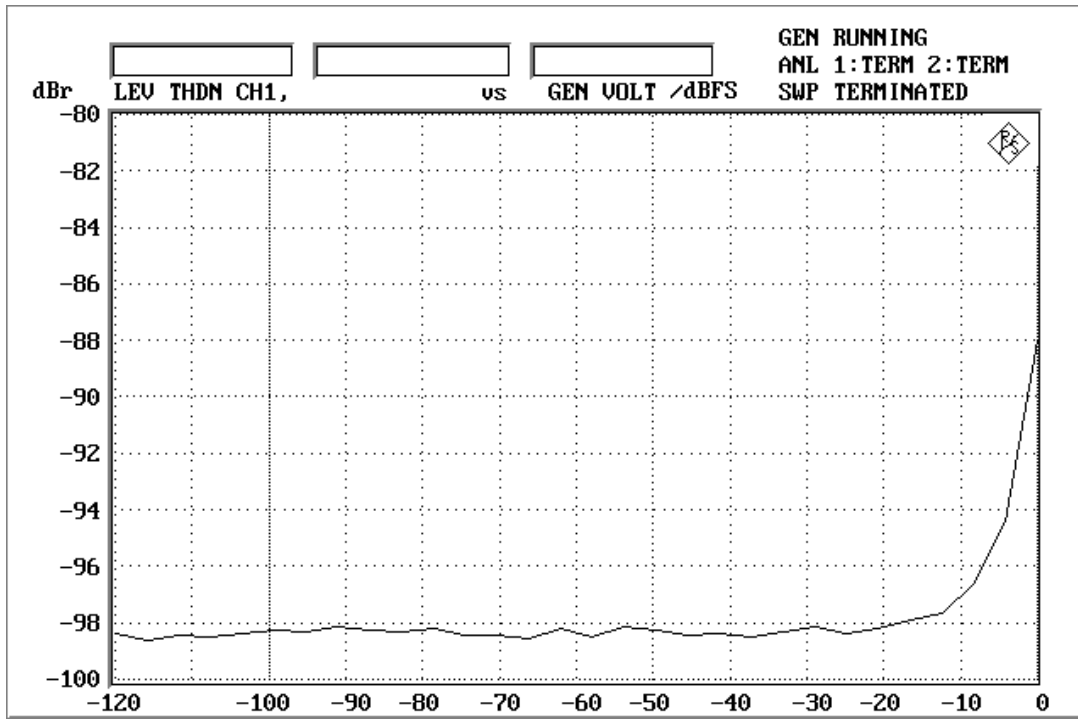

Figure 1-1-1. THD+N vs. Input level

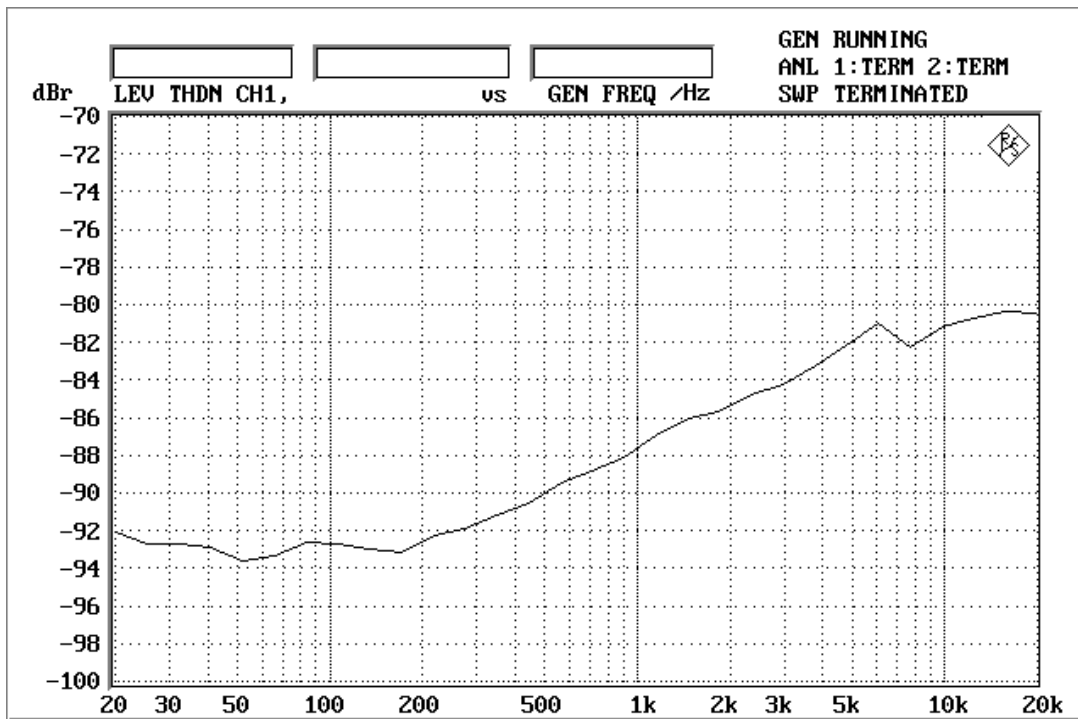

Figure 1-1-2. THD+N vs. Input frequency



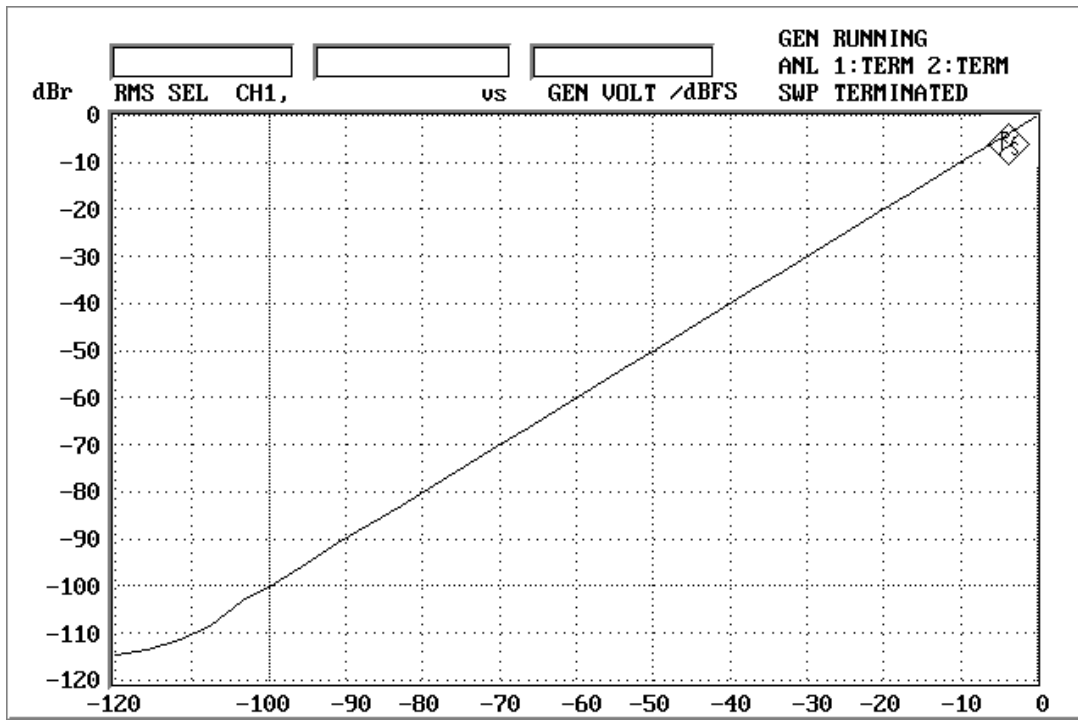

Figure 1-1-3. Linearity

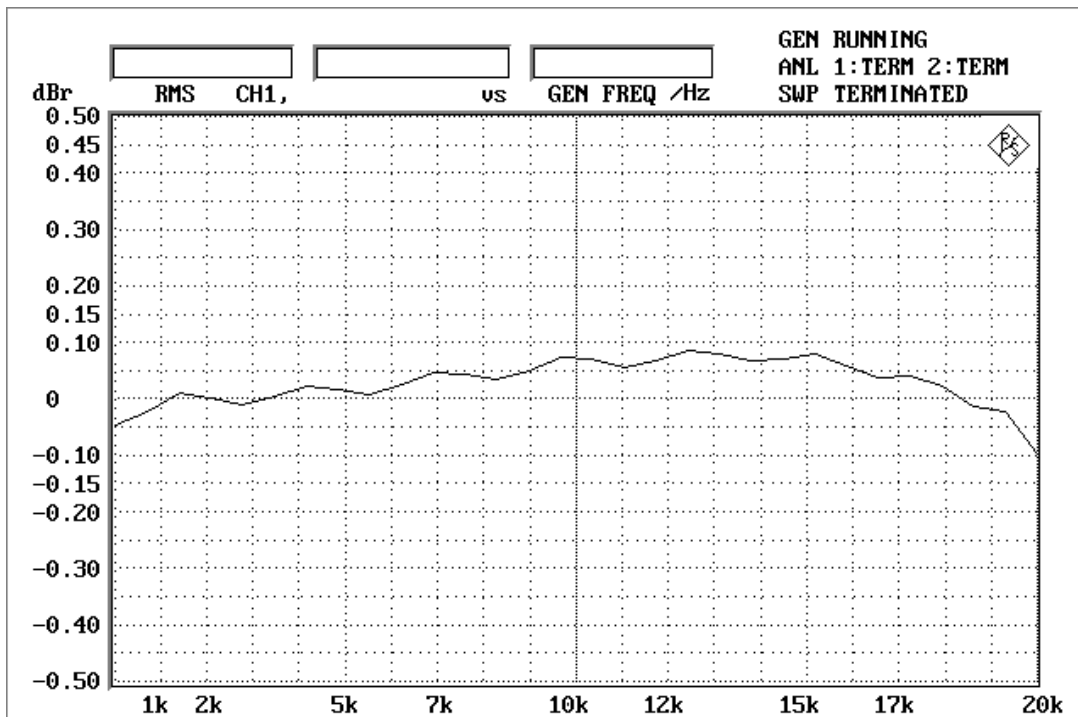

Figure 1-1-4. Frequency response

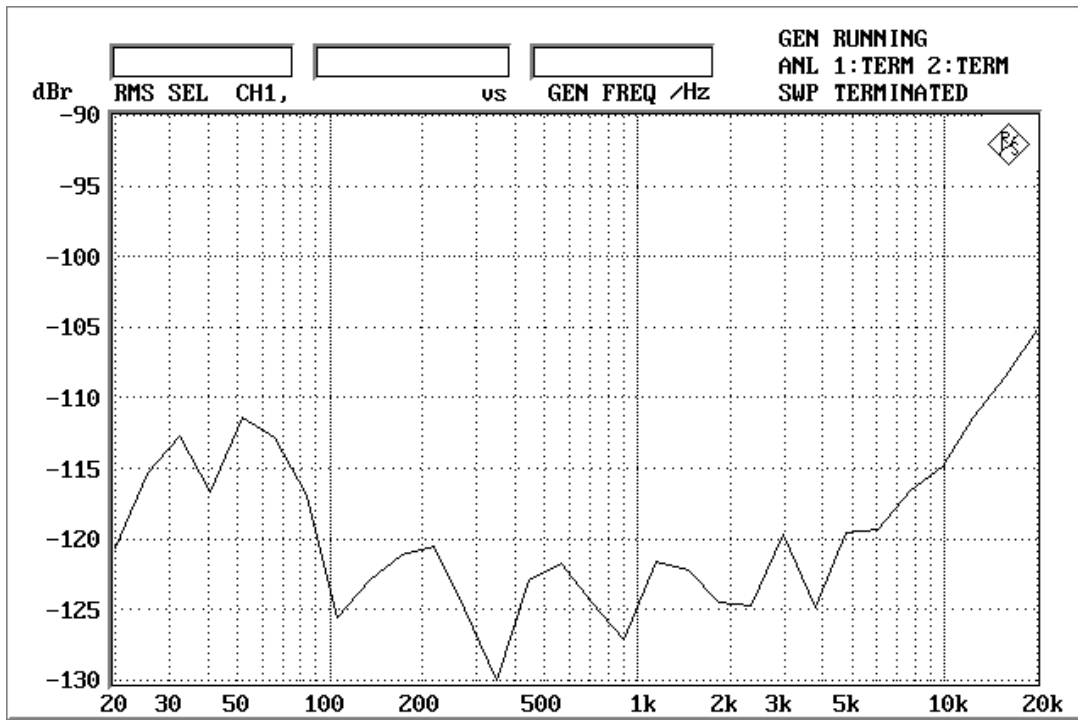

Figure 1-1-5. Cross-talk

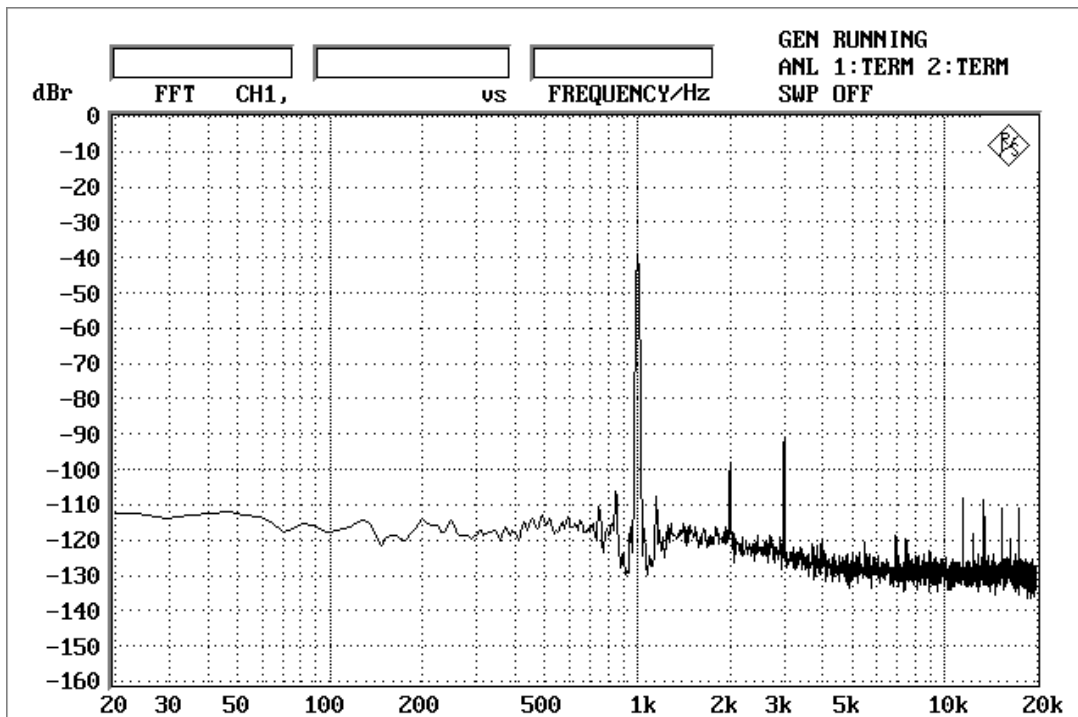

Figure 1-1-6. FFT (1kHz, 0dBFS)  
FFT points=8192, Avg=8, Notch=-30dB

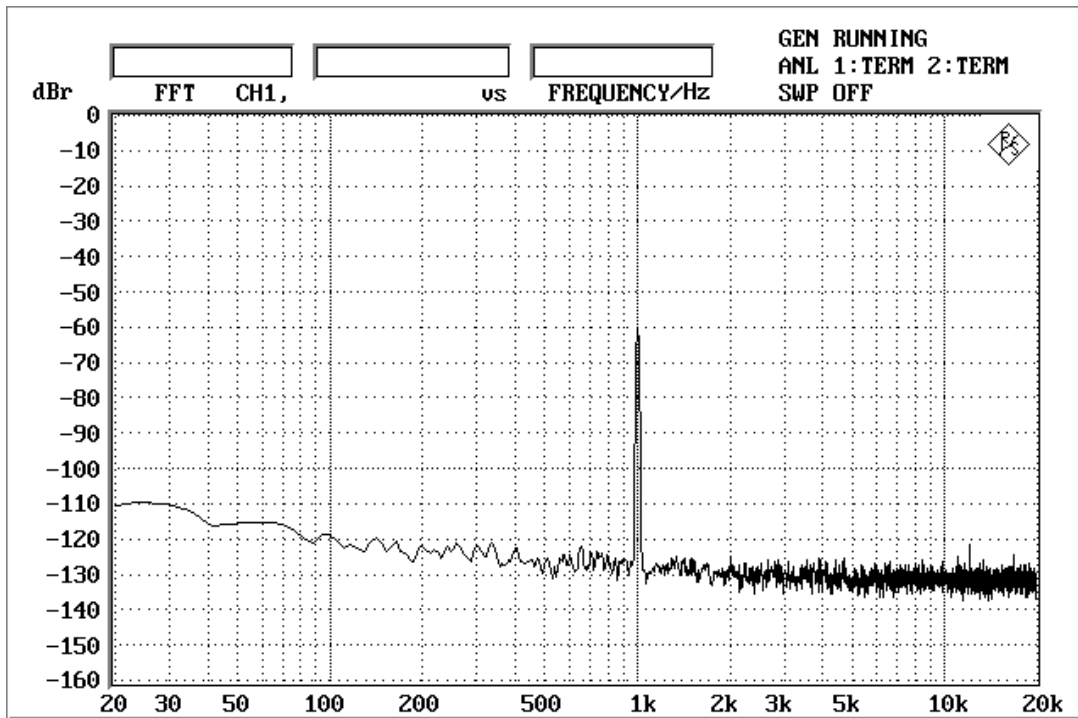

Figure 1-1-7. FFT (1kHz, -60dBFS)  
FFT points=8192, Avg=8

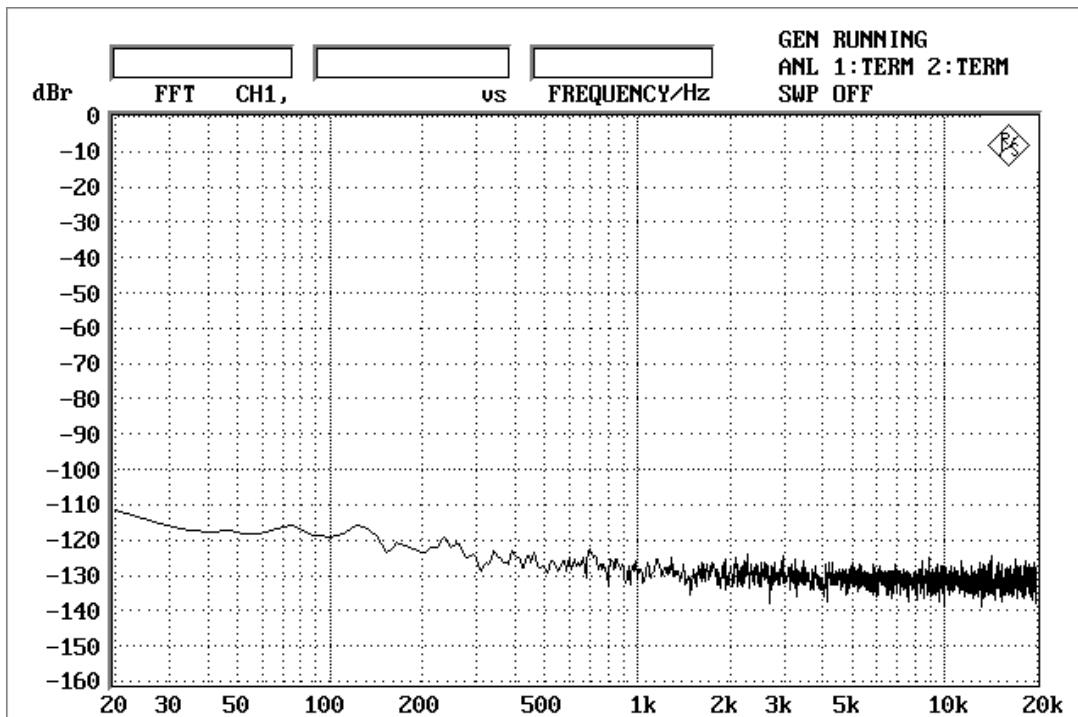

Figure 1-1-8. FFT (noise floor)  
FFT points=8192, Avg=8

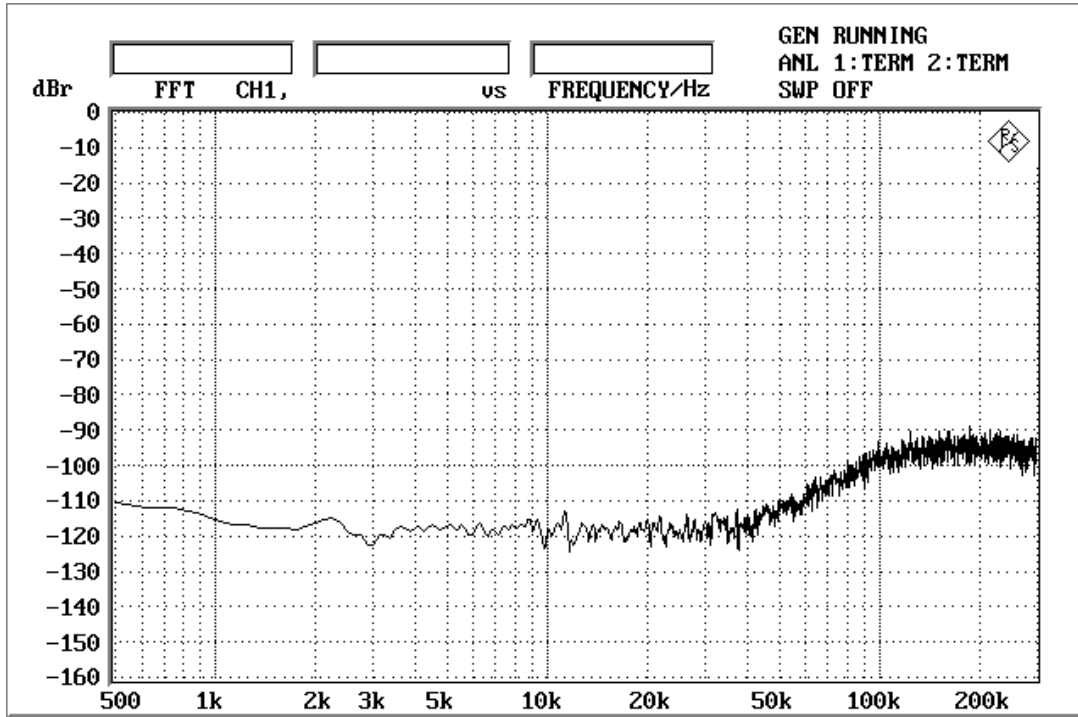

Figure 1-1-9. FFT (out-of-band noise)  
FFT points=8192, Avg=8

1-2. fs=96kHz

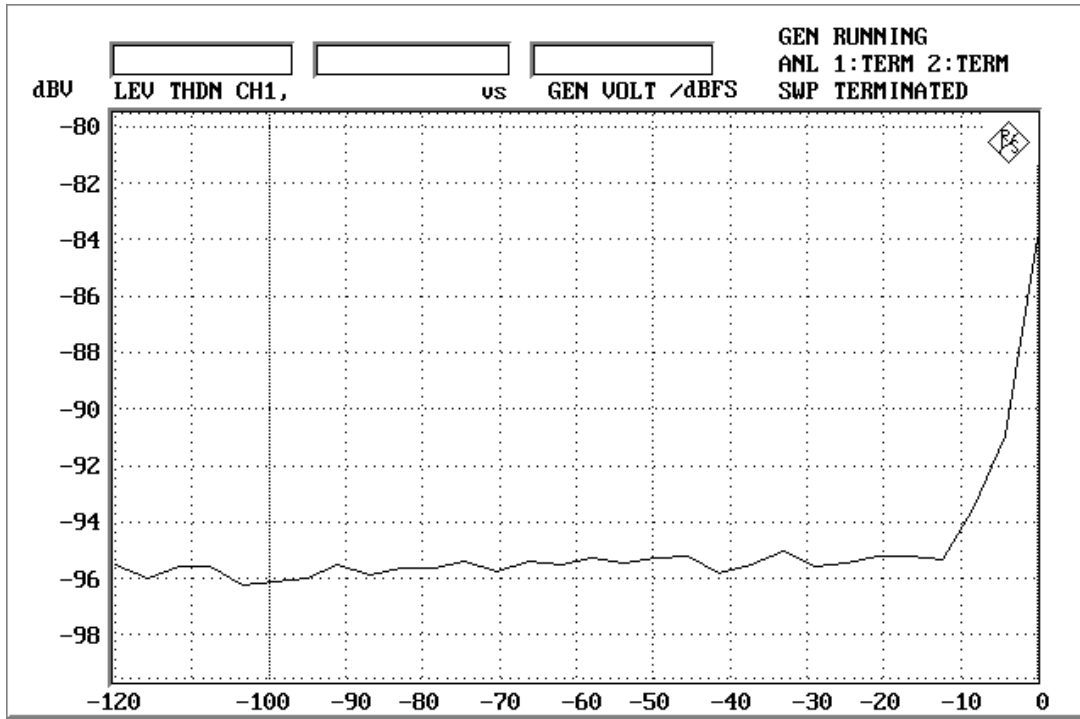

Figure 1-2-1. THD+N vs. Input level

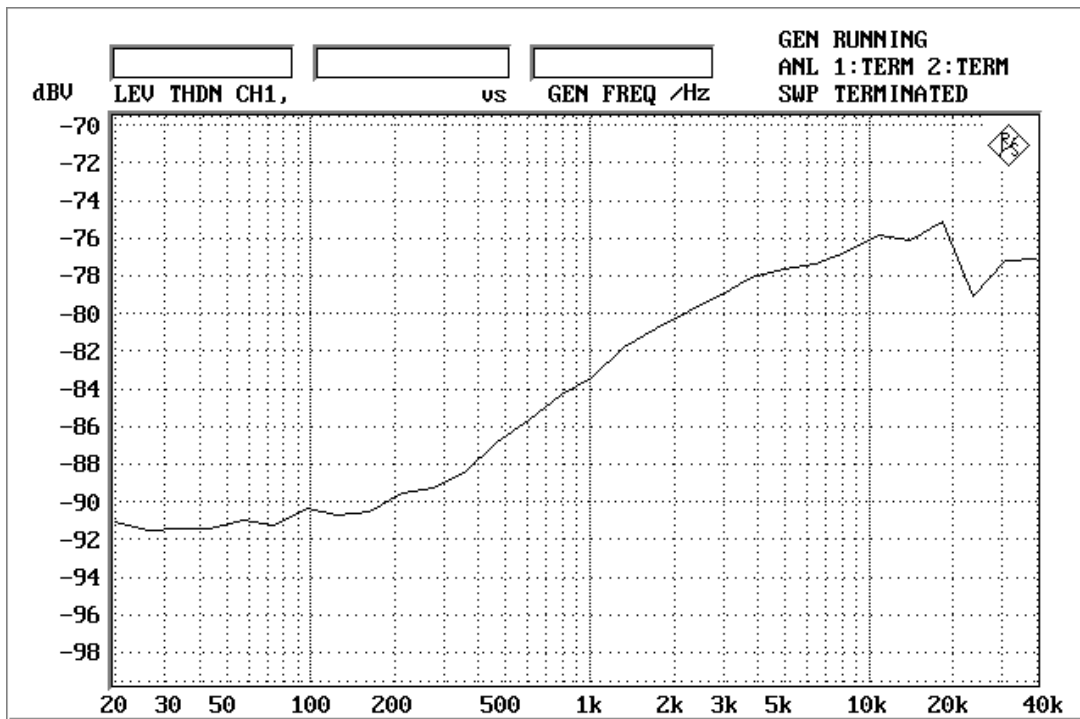

Figure 1-2-2. THD+N vs. Input frequency

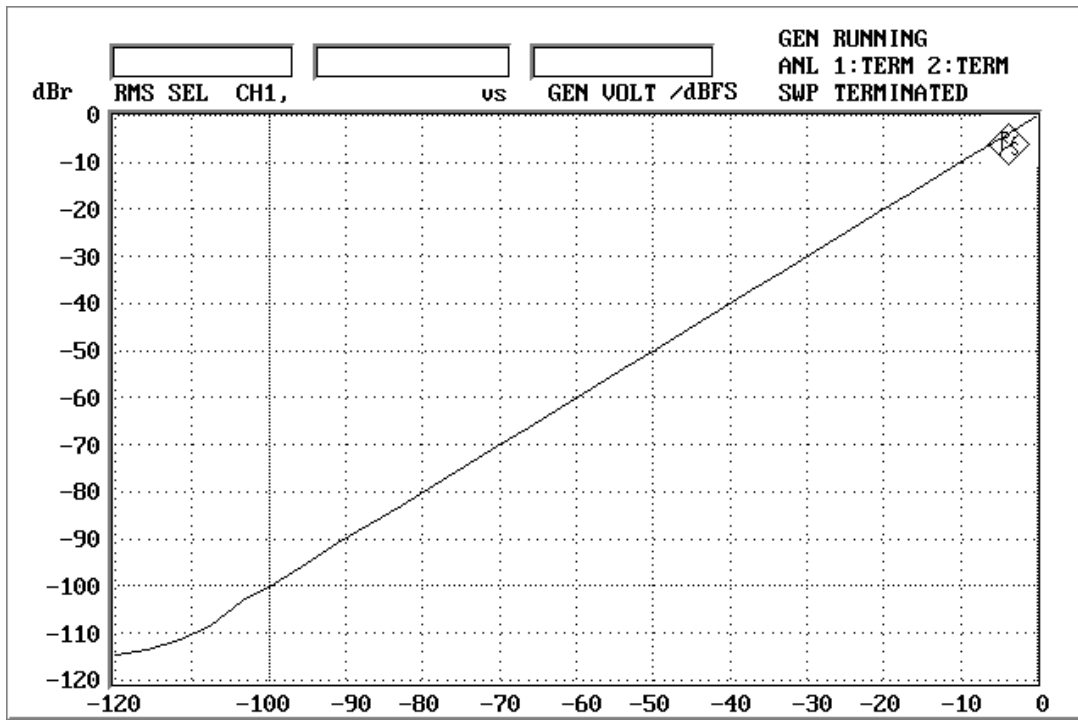

Figure 1-2-3. Linearity

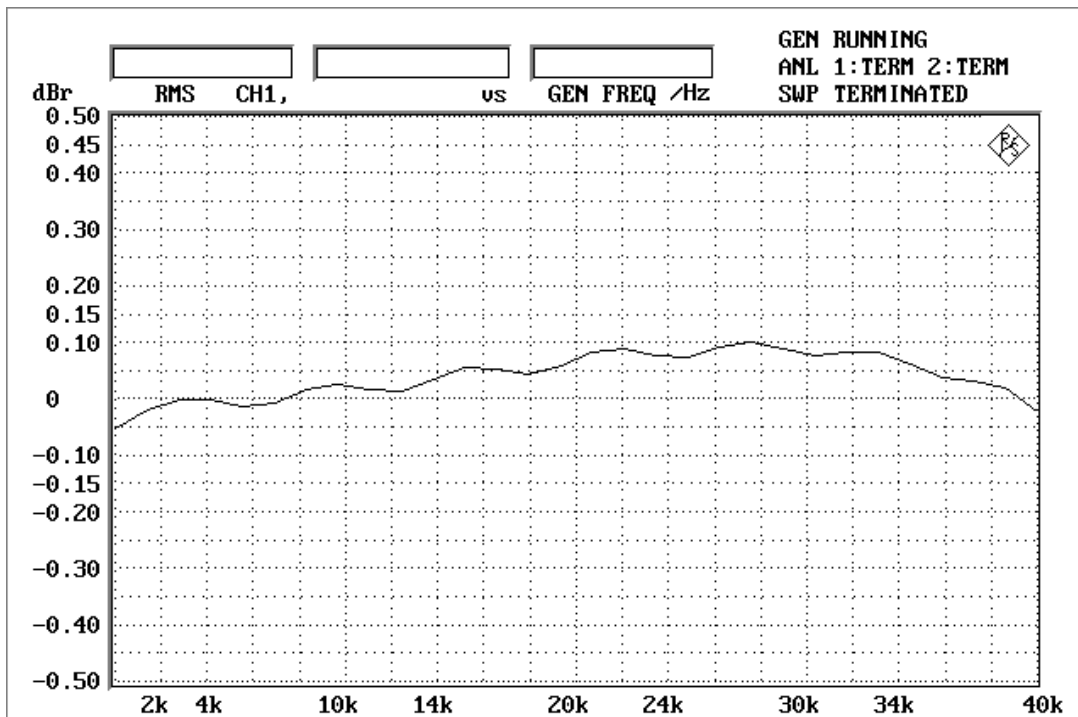

Figure 1-2-4. Frequency response

2. EXT mode  
2-1. fs=44.1kHz

AKM

AK4353 THD+N vs Input Level (AVDD=DVDD=5V, fs=44.1kHz, fin=1kHz)

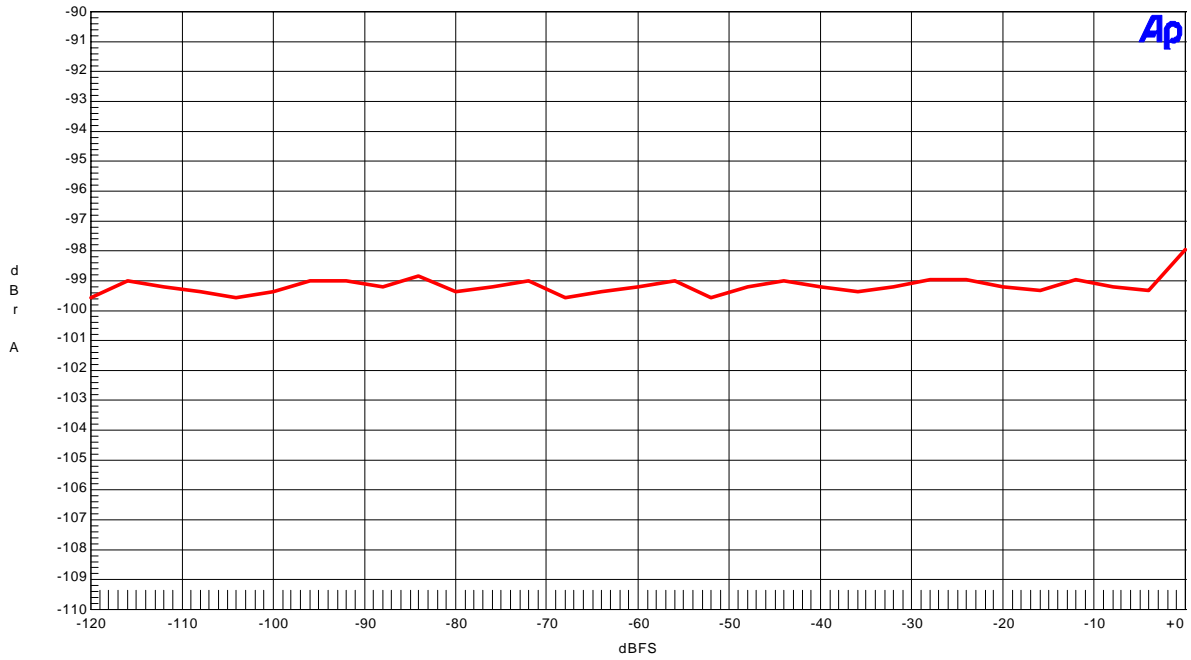

Figure 2-1-1. THD+N vs. Input level

AKM

AK4353 THD+N vs fin (AVDD=DVDD=5V, fs=44.1kHz, Input Level=0dBFS)

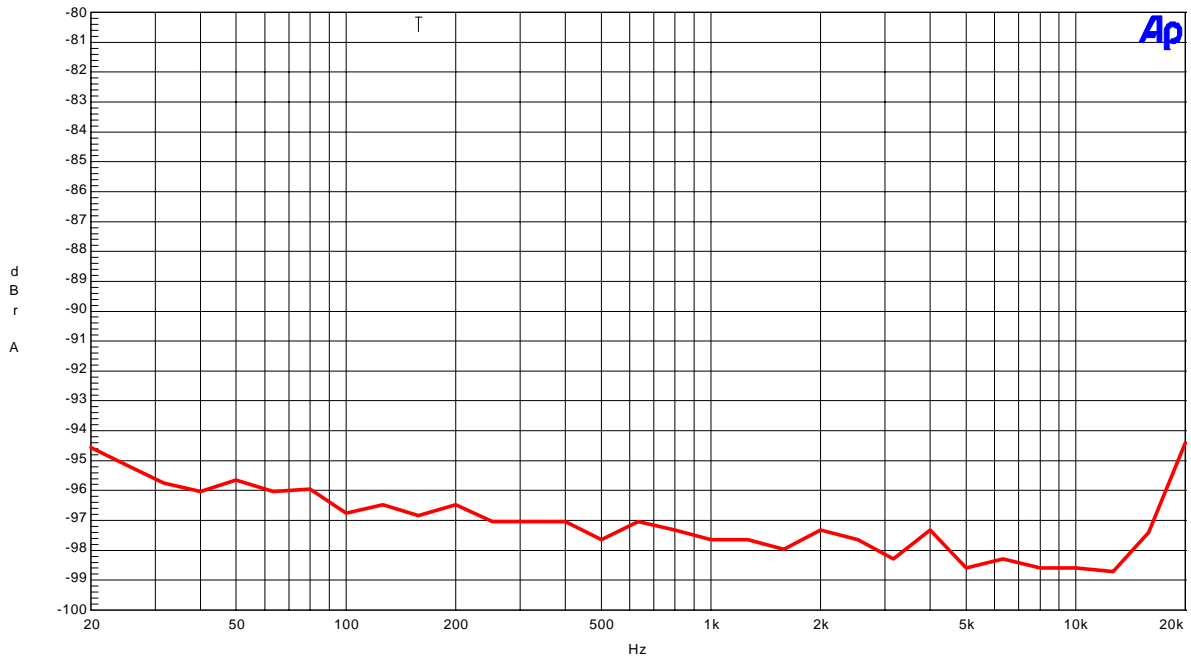

Figure 2-1-2. THD+N vs. Input frequency

AKM

AK4353 Linearity (AVDD=DVDD=5V, fs=44.1kHz, fin=1kHz)

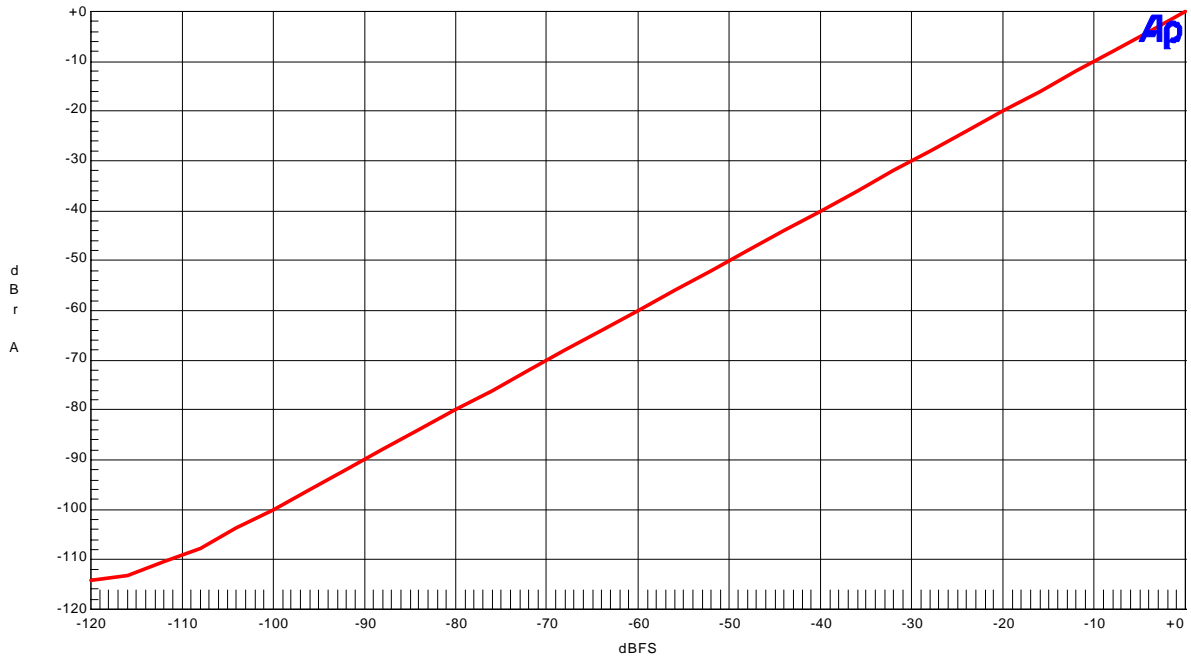

Figure 2-1-3. Linearity

AKM

AK4353 Frequency Response (AVDD=DVDD=5V, fs=44.1kHz, Input Level=0dBFS)

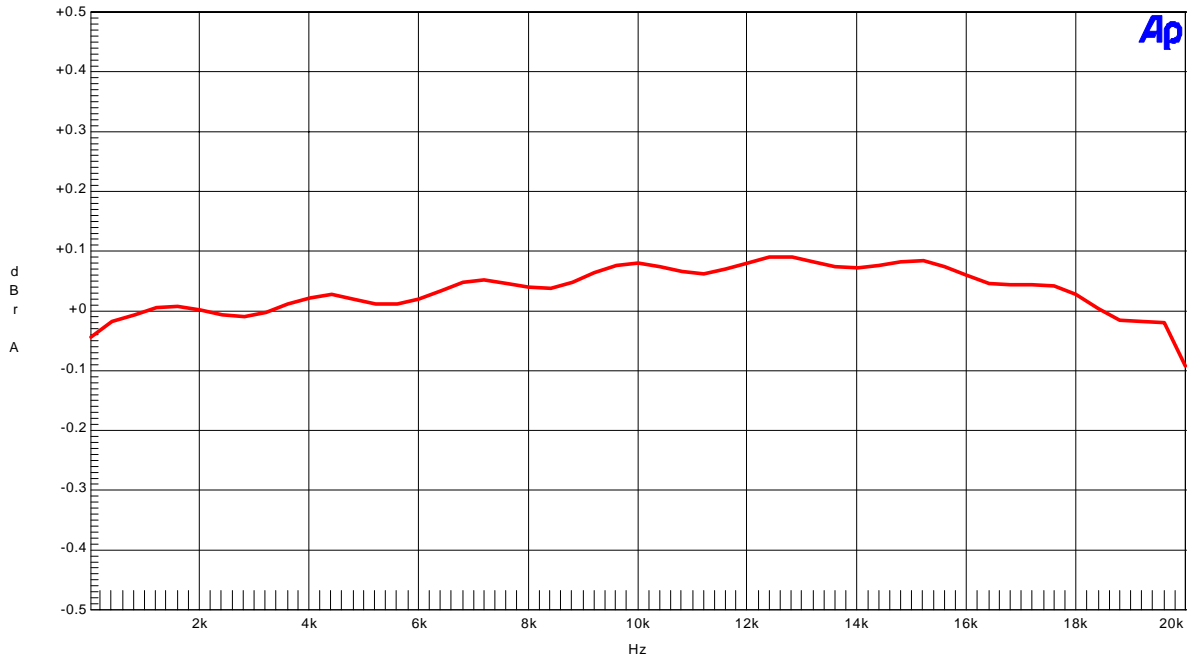

Figure 2-1-4. Frequency response



AKM

AK4353 Cross-talk (AVDD=DVDD=5V, fs=44.1kHz, Input Level=0dBFS)

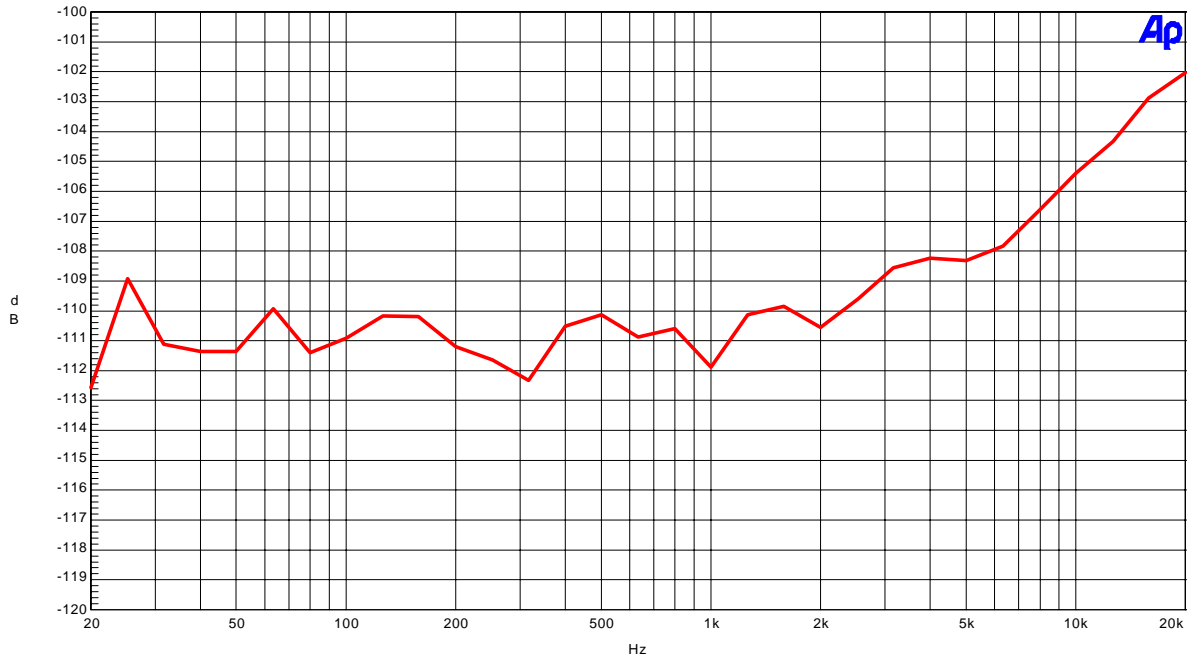

Figure 2-1-5. Cross-talk

AKM

AK4353 FFT (AVDD=DVDD=5V, fs=44.1kHz, fin=1kHz, Input Level=0dBFS)  
FFT points=16384, Avg=8, Window=Equirriple

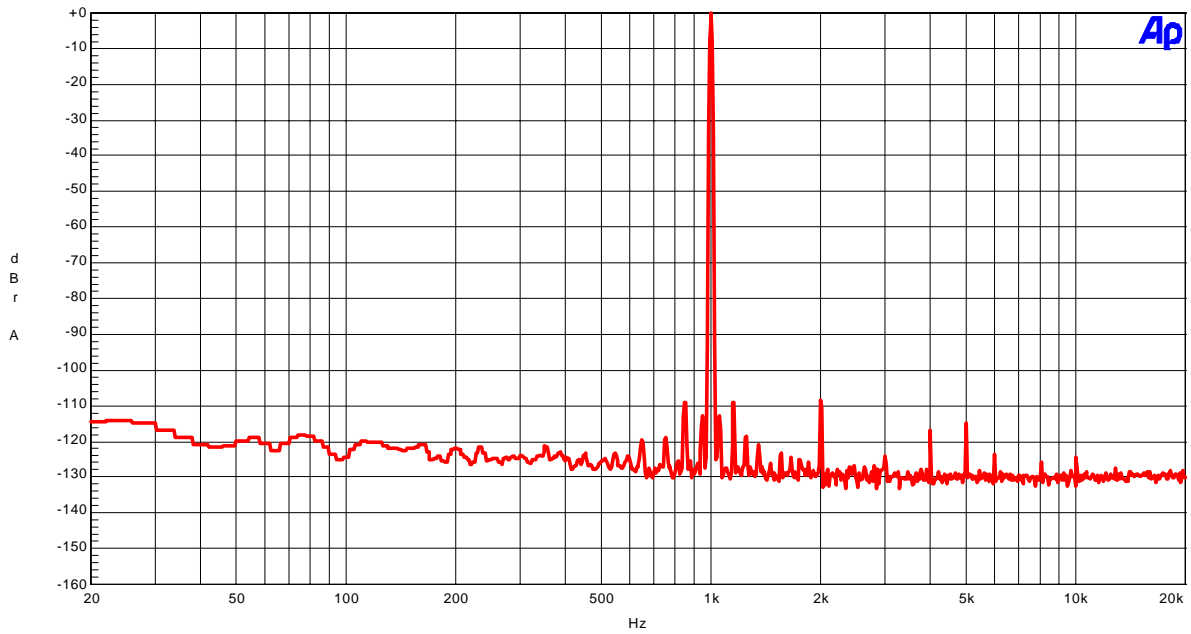

Figure 1-6. FFT (1kHz, 0dBFS)

AKM

AK4353 FFT (AVDD=DVDD=5V, fs=44.1kHz, fin=1kHz, Input Level=-60dBFS)  
FFT points=16384, Avg=8, Window=Equiripple

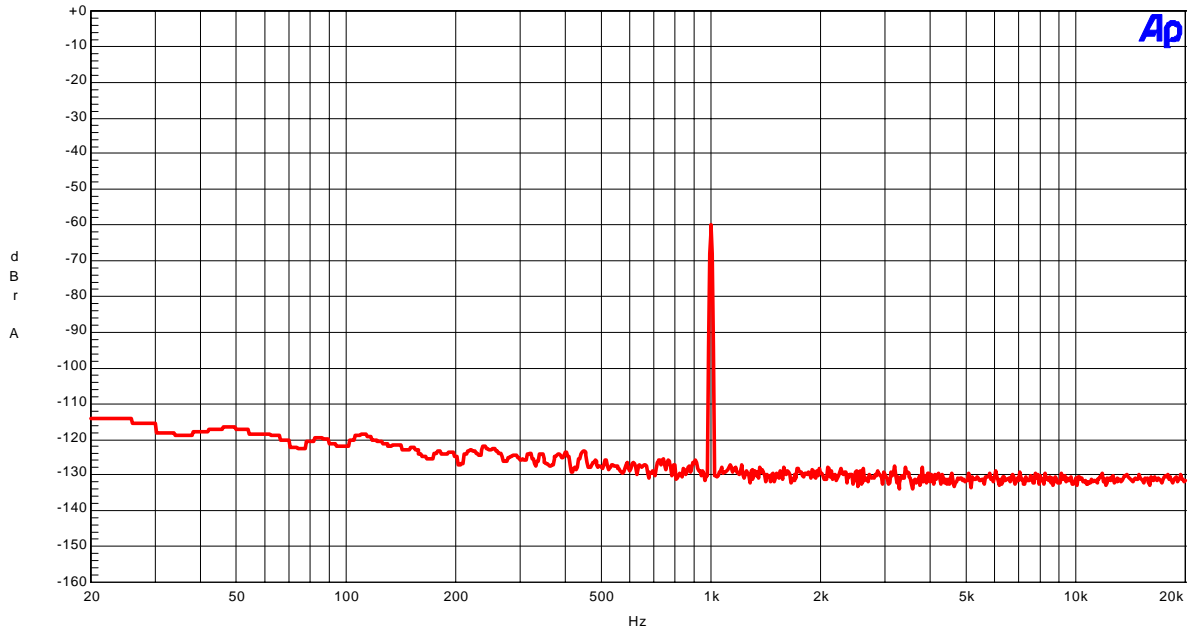

Figure 2-1-7. FFT (1kHz, -60dBFS)

AKM

AK4353 FFT (AVDD=DVDD=5V, fs=44.1kHz, No signal input)  
FFT points=16384, Avg=8, Window=Equiripple

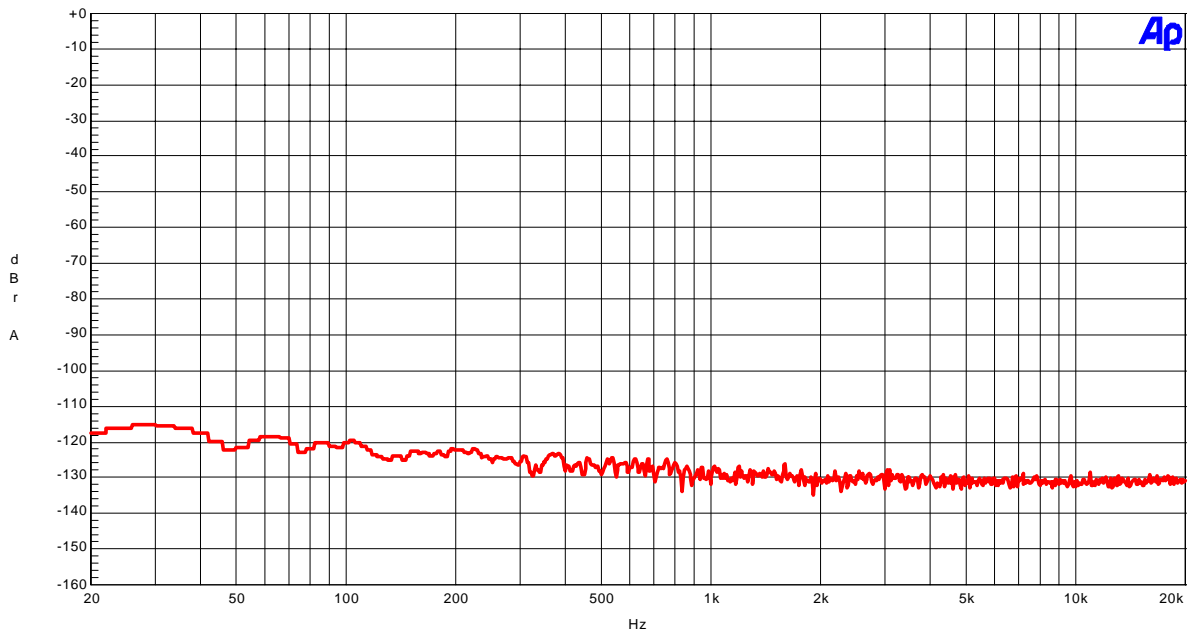

Figure 2-1-8. FFT (noise floor)

AKM

AK4353 FFT (Outband noise ~130kHz; AVDD=DVDD=5V, fs=44.1kHz, No signal input)  
FFT points=16384, Avg=8, Window=Equiripple

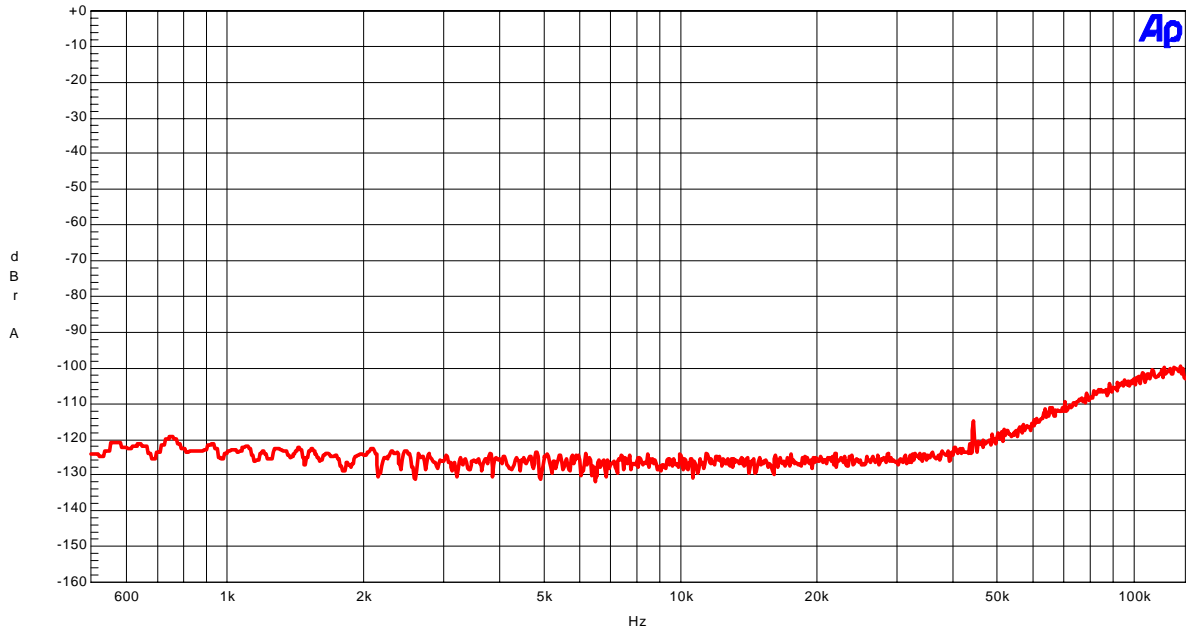

Figure 2-1-9. FFT (out-of-band noise)

2-2. fs=96kHz

AKM

AK4353 THD+N vs Input Level (AVDD=DVDD=5V, fs=96kHz, fin=1kHz)

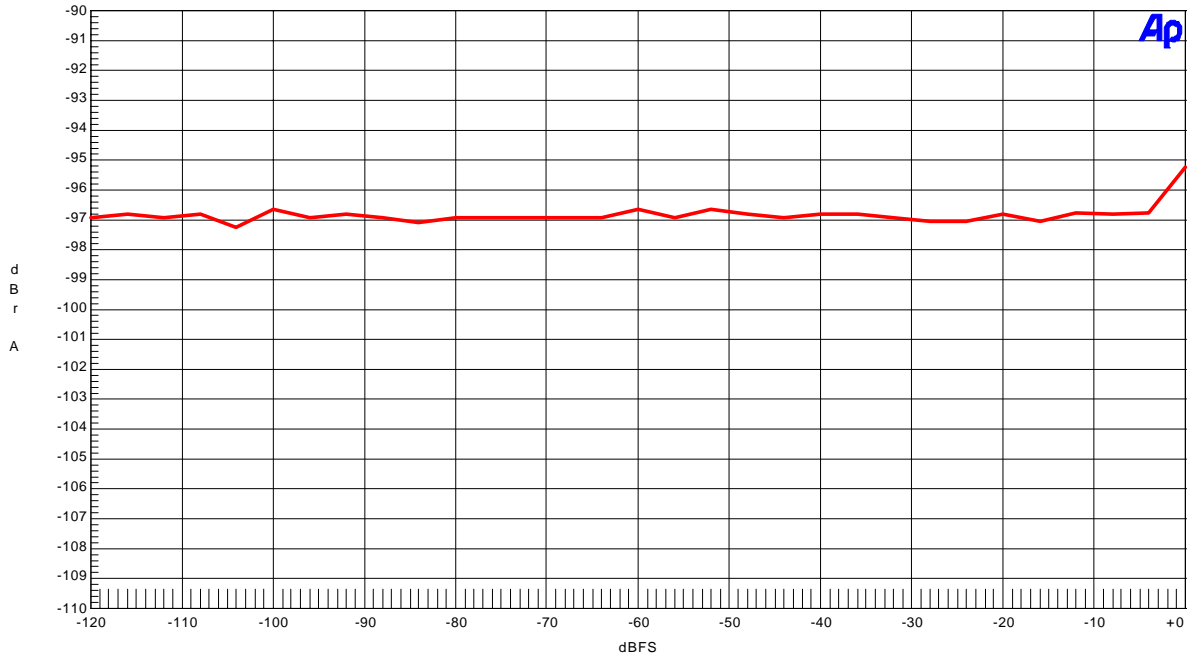

Figure 2-2-1. THD+N vs. Input level

AKM

AK4353 THD+N vs fin (AVDD=DVDD=5V, fs=96kHz, Input Level=0dBFS)

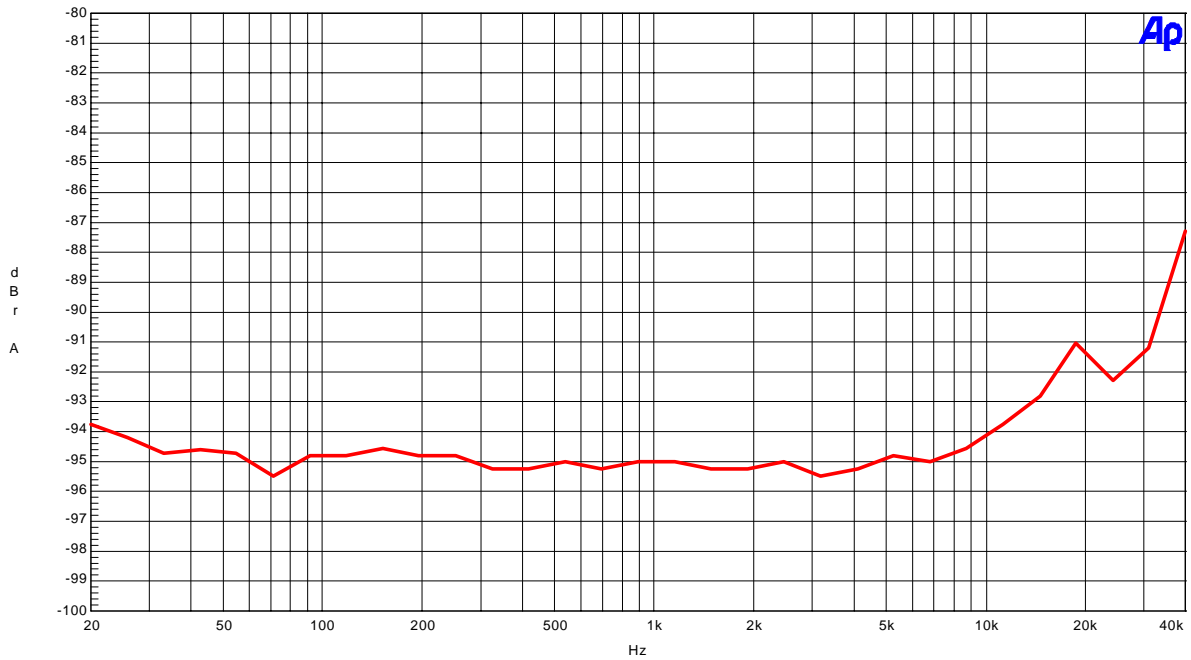

Figure 3-2-2. THD+N vs. Input frequency

AKM

AK4353 Linearity (AVDD=DVDD=5V, fs=96kHz, fin=1kHz)

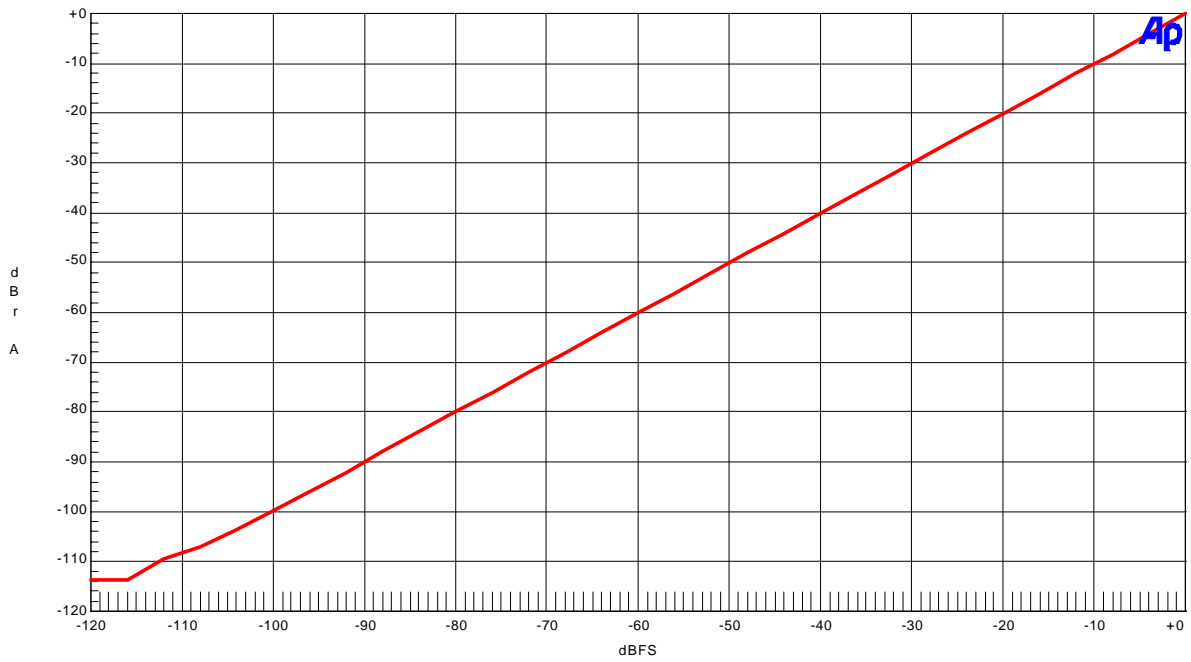

Figure 2-2-3. Linearity

AKM

AK4353 Frequency Response (AVDD=DVDD=5V, fs=96kHz, Input Level=0dBFS)

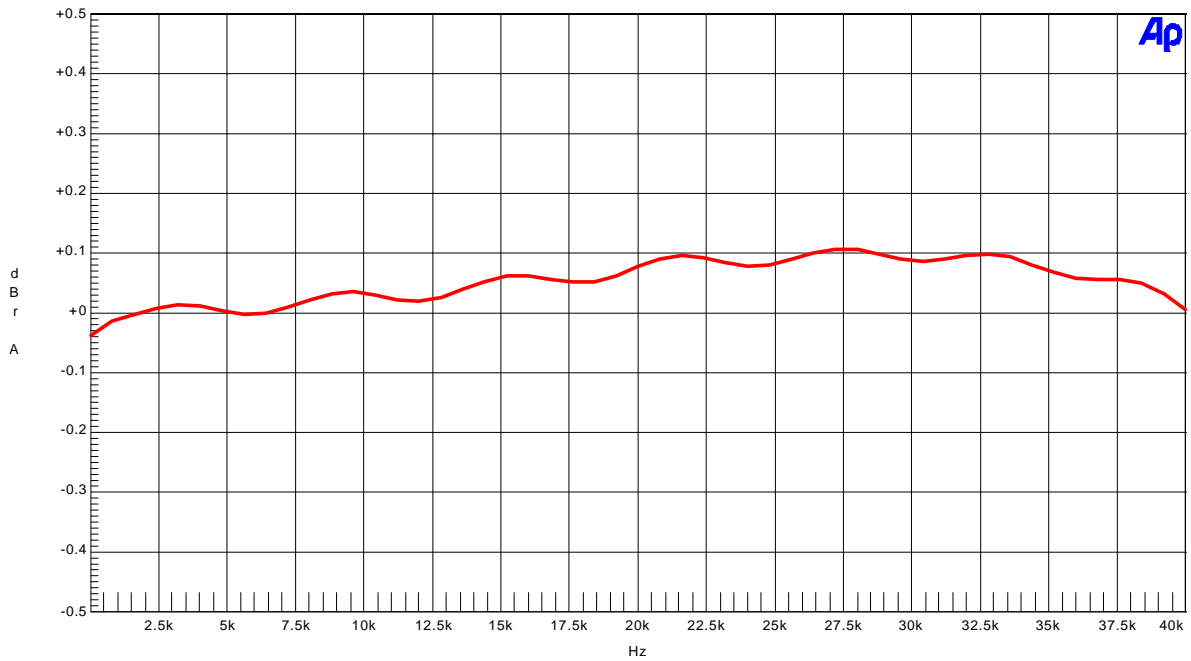

Figure 2-2-4. Frequency response

**AKD4364 Control Program ver 2.0 operation manual**

1. Connect IBM-AT compatible PC with AKD4364 by 10-line type flat cable (packed with AKD4364).  
Take care of the direction of 10pin Header (Refer to manual of AKD4364).
2. Start up "WINDOWS 95" or "WINDOWS 98".
3. Insert the floppy-disk labeled "AKD4364 Control Program ver 2.0" into the floppy-disk drive.
4. Set up "MS-DOS" from start menu.
5. Change directory to the floppy-disk drive(ex.a:) at MS-DOS prompt.
6. Type "ak4364".
7. Then follow the displayed comment (See the following).

```
===== <<Operating flow>> =====  
Input Control Mode (3-wire serial or I2C bus)  
Input Chip Address (2bit)  
Write data/ Display register map/ Reset etc.  loop  
=====
```

At first the following message is displayed:

```
***** AK4364 Control Program ver 2.0 , '00/4 *****
copyright(c) 2000, Asahi Kasei Microsystems co.,ltd.
        All rights reserved.

Input control mode
    0: 3-wire Serial, 1: I2C Bus
:
```

Input 0 or 1.

Then the following is displayed:

```
Input Chip Address(CAD1,CAD0) (2 figure, binary) =
```

Input chip address in 2 figures of binary.

Set CAD1 and CAD0 before the AKD4364 is powered up.

When hanging CAD1 and CAD0, set SW1(-PD) "L", then "H" after that.

After chip address is defined, the following default register map is displayed (Loop starts from here):

```
3-wire Serial control mode    CAD1-0=00 -----
ADDR = 00 : 0B <Control 1> ( 0   0   0   EXT  DIF2  DIF1  DIF0  RSTN )
ADDR = 01 : 01 <Control 2> ( FS1  FS0  DFS1  DFS0  CKS2  CKS1  CKS0  RSTN )
ADDR = 02 : 94 <Control 3> ( PL3  PL2  PL1  PL0  DEM1  DEM0  ATC   SMUTE )
ADDR = 03 : FF <Lch ATT>    ( ATT7  ATT6  ATT5  ATT4  ATT3  ATT2  ATT1  ATT0 )
ADDR = 04 : FF <Rch ATT>    ( ATT7  ATT6  ATT5  ATT4  ATT3  ATT2  ATT1  ATT0 )
ADDR = 05 : 00 <TX>         ( 0    0    0    0    0    0    0    V   TXE )
ADDR = 06 : 00 <Ch Status 1>( 0    CS29  CS28  CS24  CS3   CS2   CS2   CS1 )
ADDR = 07 : 04 <Ch Status 2>( CS15  CS14  CS13  CS12  CS11  CS10  CS9   CS8 )

Input 1(Write), R(Reset), T(Table), I(Increment), D(Decrement) or S(Stop) :
```

1) If you input "1", you can write data to AK4364.

```
You can write data to AK4364
Input Register Address (2 figure, hex) (00-07) =
```

Input register address in 2 figures of hexadecimal.

Then current data of this address is displayed:

```
ADDR = 00 : 0B <Control 1> ( 0   0   0   EXT  DIF2  DIF1  DIF0  RSTN )
                          0   0   0   0   1   0   1   1
Input Register Data (2 figure, hex) (00-FF) =
```

You can write control data to this address. Input control data in 2 figures of hexadecimal.

Refer to datasheet of AK4364.

Then the data written to this address is displayed:

```
ADDR = 00 : 09 <Control 1> ( 0   0   0   EXT  DIF2  DIF1  DIF0  RSTN )
                          0   0   0   0   1   0   0   1
```

- 2) If you input "R" or "r", this program writes default data to all register addresses.
- 3) If you input "T" or "t", current register map is displayed.
- 4) If you input "I" or "i", this program increment data of current address by 1 (only for addr=03H or 04H). You can increment ATT value by 1step.
- 5) If you input "D" or "d", this program decrement data of current address by 1 (only for addr=03H or 04H). You can decrement ATT value by 1step.
- 6) If you input "S" or "s", this program is terminated.



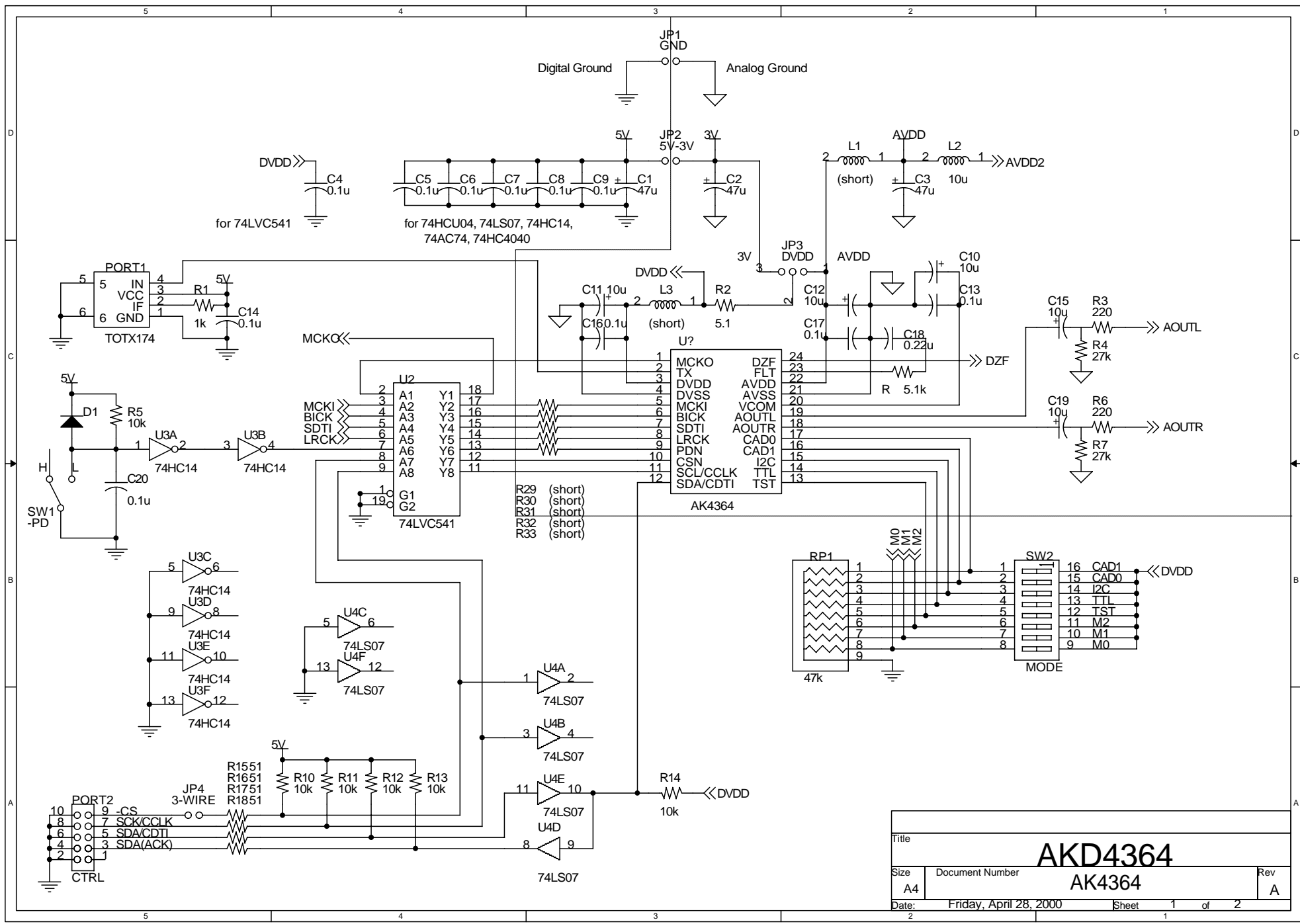

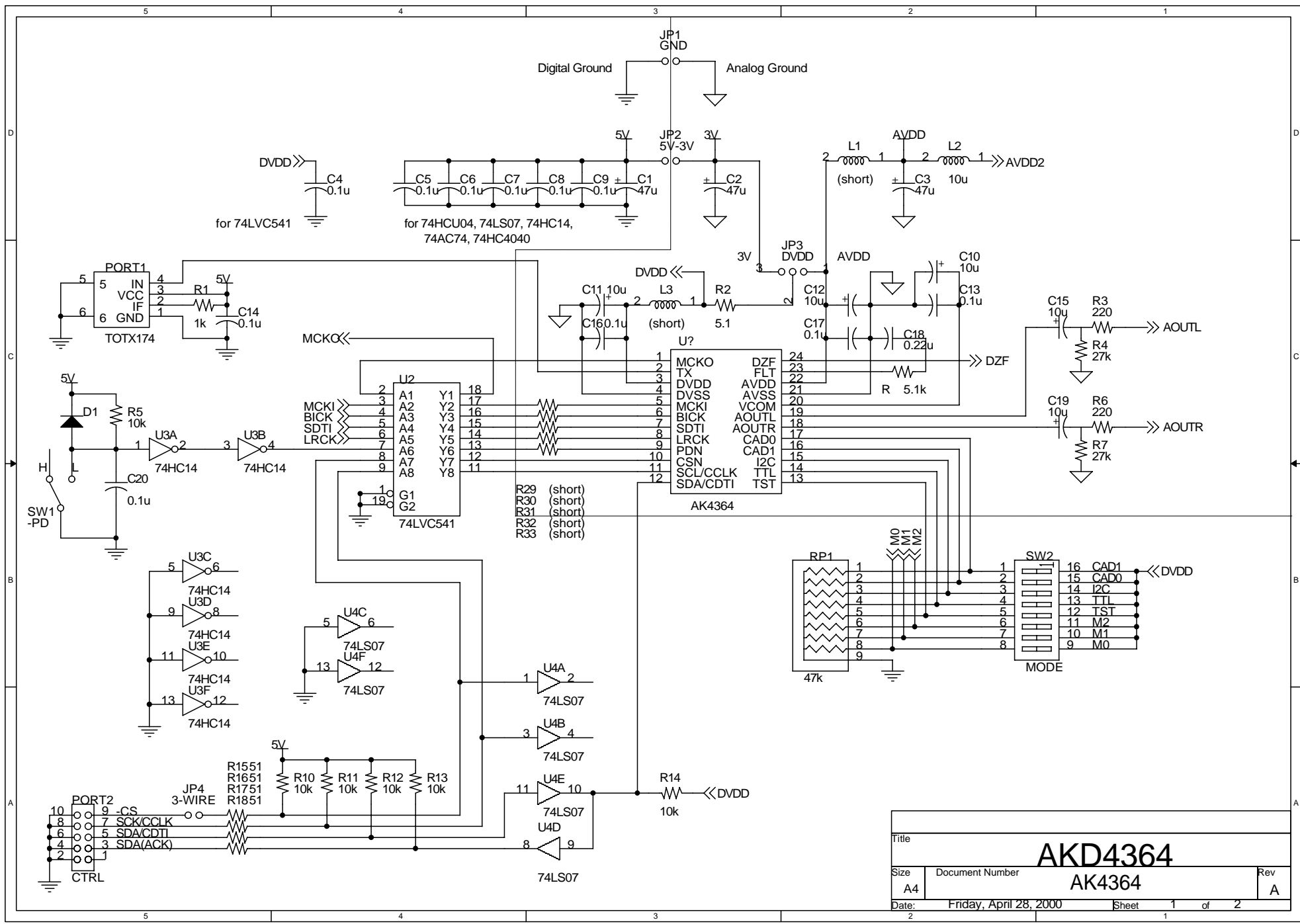

|       |                        |  |                |   |      |
|-------|------------------------|--|----------------|---|------|
| Title |                        |  | <b>AKD4364</b> |   |      |
| Size  | Document Number        |  | AK4364         |   | Rev  |
| A4    |                        |  |                |   | A    |
| Date: | Friday, April 28, 2000 |  | Sheet          | 1 | of 2 |

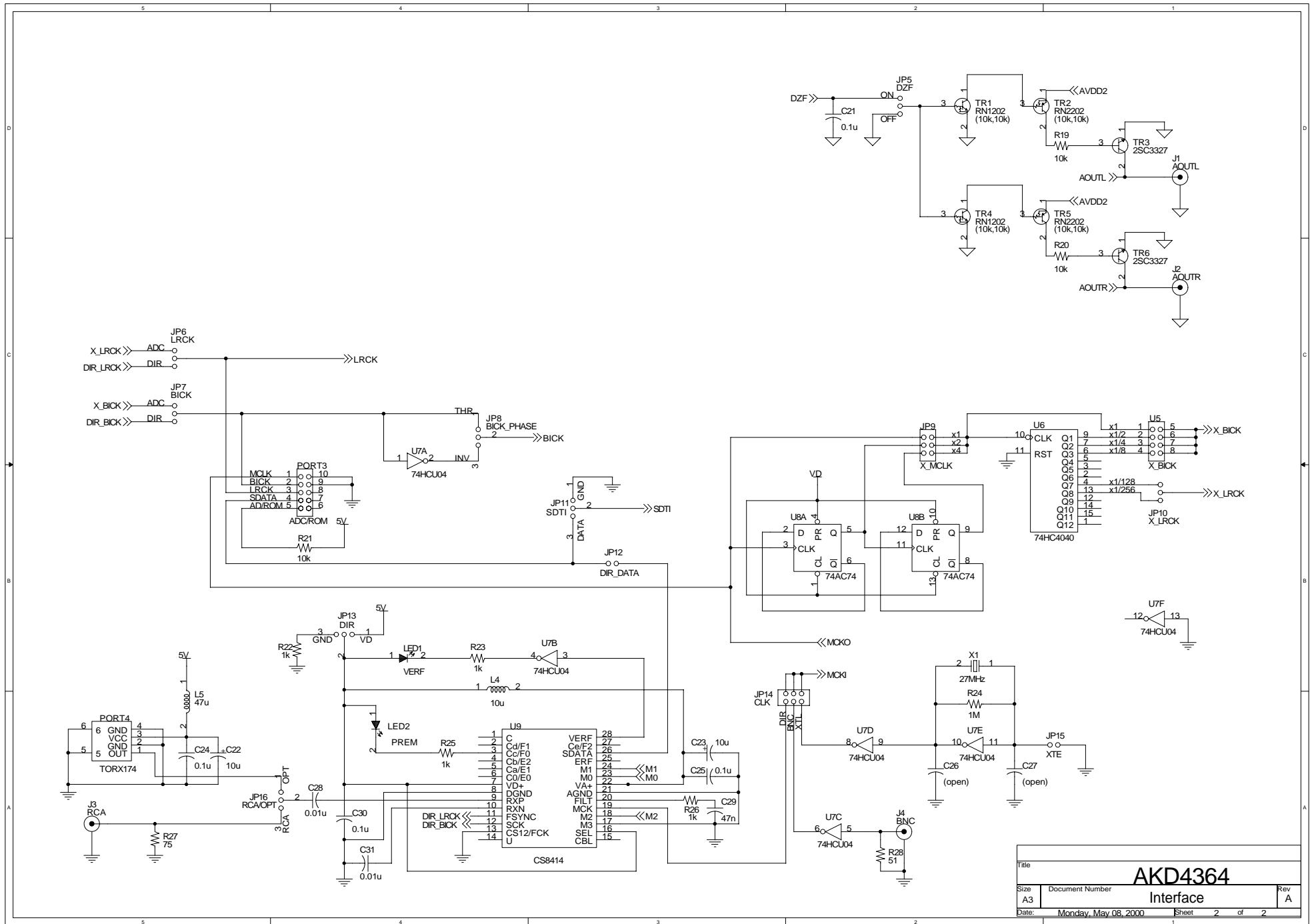

|                |                      |              |
|----------------|----------------------|--------------|
| Title          |                      |              |
| <b>AKD4364</b> |                      |              |
| Size           | Document Number      | Rev          |
| A3             | Interface            | A            |
| Date:          | Monday, May 08, 2000 | Sheet 2 of 2 |

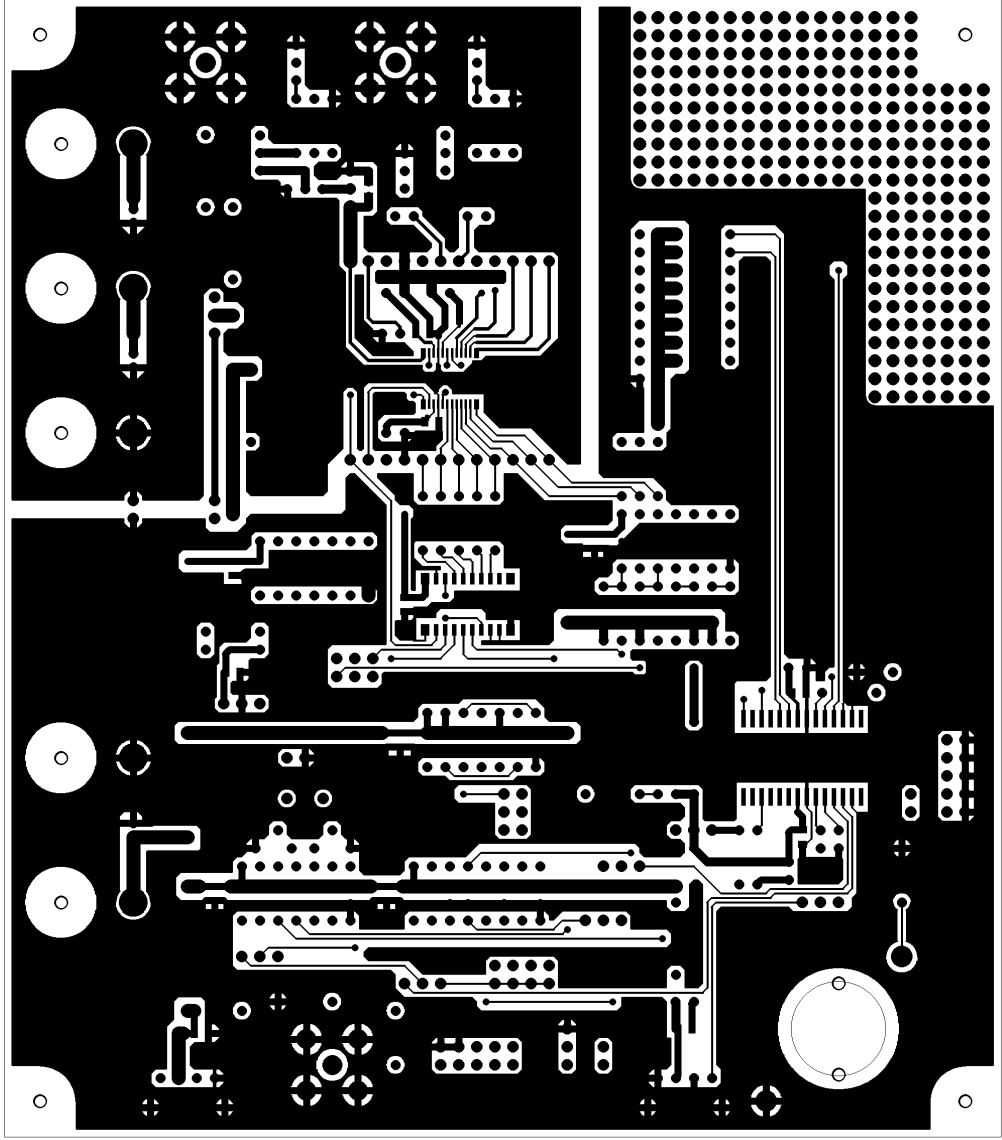

L1 部品面 AKD4363 Rev.A

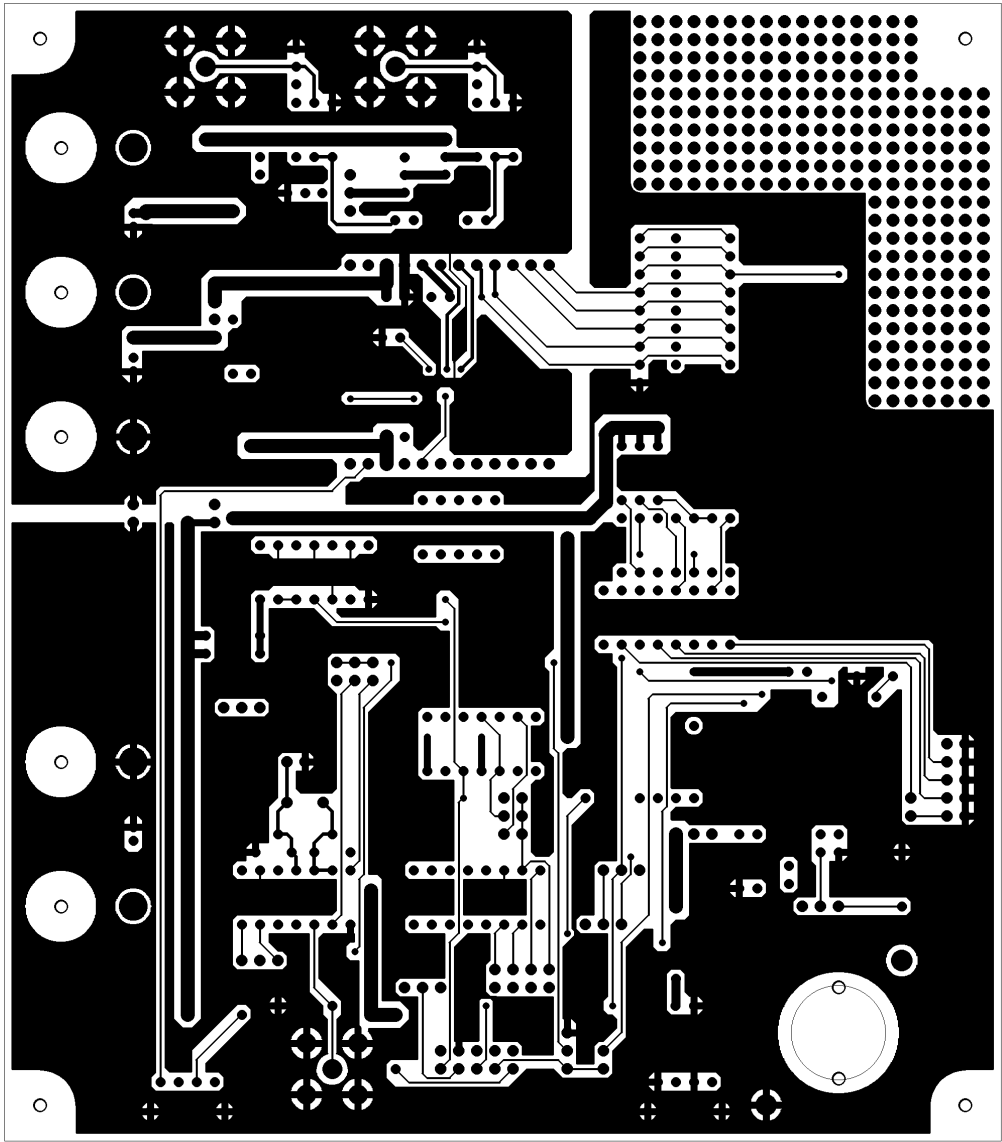

TS 板图 KDN383 Rev.A

#### IMPORTANT NOTICE

- These products and their specifications are subject to change without notice. Before considering any use or application, consult the Asahi Kasei Microsystems Co., Ltd. (AKM) sales office or authorized distributor concerning their current status.
- AKM assumes no liability for infringement of any patent, intellectual property, or other right in the application or use of any information contained herein.
- Any export of these products, or devices or systems containing them, may require an export license or other official approval under the law and regulations of the country of export pertaining to customs and tariffs, currency exchange, or strategic materials.
- AKM products are neither intended nor authorized for use as critical components in any safety, life support, or other hazard related device or system, and AKM assumes no responsibility relating to any such use, except with the express written consent of the Representative Director of AKM. As used here:
  - (a) A hazard related device or system is one designed or intended for life support or maintenance of safety or for applications in medicine, aerospace, nuclear energy, or other fields, in which its failure to function or perform may reasonably be expected to result in loss of life or in significant injury or damage to person or property.
  - (b) A critical component is one whose failure to function or perform may reasonably be expected to result, whether directly or indirectly, in the loss of the safety or effectiveness of the device or system containing it, and which must therefore meet very high standards of performance and reliability.
- It is the responsibility of the buyer or distributor of an AKM product who distributes, disposes of, or otherwise places the product with a third party to notify that party in advance of the above content and conditions, and the buyer or distributor agrees to assume any and all responsibility and liability for and hold AKM harmless from any and all claims arising from the use of said product in the absence of such notification.