

## CMOS 8-Bit Microcontroller

## TMP86C420U/F, TMP86C820U/F

The TMP86C420/820 are the high-speed, high-performance and low power consumption 8-bit microcomputer, including ROM, RAM, LCD driver, multi-function timer/counter, serial interface (SIO), a 8-bit AD converter and two clock generators on chip.

Product No.	ROM	RAM	PACKAGE	OTP MCU
TMP86C420U/F	4 K × 8 bits	256 × 8 bits	P-LQFP64-1010-0.50	TMP86PM29AU/AF
TMP86C820U/F	8 K × 8 bits		P-QFP64-1414-0.80A	

## Features

- ◆ 8-bit single chip microcomputer TLCS-870/C series
- ◆ Instruction execution time: 0.25  $\mu$ S (at 16 MHz)  
122  $\mu$ S (at 32.768 kHz)
- ◆ 132 types and 731 basic instructions
- ◆ 15 interrupt sources (External: 5, Internal: 10)
- ◆ Input/Output ports (39 pins)  
(Out of which 24 pins are also used as SEG pins)
- ◆ 18-bit timer counter: 1 ch
  - Timer, Event counter, Pulse width measurement, Frequency measurement modes
- ◆ 8-bit timer counter: 2 ch
  - Timer, Event counter, PWM output, Programmable Divider Output PPG modes
- ◆ Time Base Timer
- ◆ Divider output function

P-LQFP64-1010-0.50

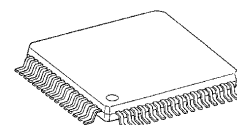
TMP86C420U  
TMP86C820U

P-QFP64-1414-0.80A

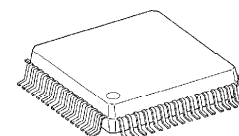
TMP86C420F  
TMP86C820F

030519EBP1

- The information contained herein is subject to change without notice.
- The information contained herein is presented only as a guide for the applications of our products. No responsibility is assumed by TOSHIBA CORPORATION for any infringements of intellectual property or other rights of the third parties which may result from its use. No license is granted by implication or otherwise under any intellectual property or other rights of TOSHIBA CORPORATION or others.
- TOSHIBA is continually working to improve the quality and reliability of its products. Nevertheless, semiconductor devices in general can malfunction or fail due to their inherent electrical sensitivity and vulnerability to physical stress. It is the responsibility of the buyer, when utilizing TOSHIBA products, to comply with the standards of safety in making a safe design for the entire system, and to avoid situations in which a malfunction or failure of such TOSHIBA products could cause loss of human life, bodily injury or damage to property. In developing your designs, please ensure that TOSHIBA products are used within specified operating ranges as set forth in the most recent TOSHIBA products specifications. Also, please keep in mind the precautions and conditions set forth in the "Handling Guide for Semiconductor Devices," or "TOSHIBA Semiconductor Reliability Handbook" etc..
- The TOSHIBA products listed in this document are intended for usage in general electronics applications (computer, personal equipment, office equipment, measuring equipment, industrial robotics, domestic appliances, etc.). These TOSHIBA products are neither intended nor warranted for usage in equipment that requires extraordinarily high quality and/or reliability or a malfunction or failure of which may cause loss of human life or bodily injury ("Unintended Usage"). Unintended Usage include atomic energy control instruments, airplane or spaceship instruments, transportation instruments, traffic signal instruments, combustion control instruments, medical instruments, all types of safety devices, etc.. Unintended Usage of TOSHIBA products listed in this document shall be made at the customer's own risk.
- The products described in this document are subject to the foreign exchange and foreign trade laws.
- TOSHIBA products should not be embedded to the downstream products which are prohibited to be produced and sold, under any law and regulations.
- For a discussion of how the reliability of microcontrollers can be predicted, please refer to Section 1.3 of the chapter entitled Quality and Reliability Assurance/Handling Precautions.

- ◆ Watchdog timer
  - Interrupt source/reset output (programmable)
- ◆ Serial interface
  - 8-bit SIO: 1ch
- ◆ 8-bit successive approximation type AD converter
  - Analog input: 8 ch
- ◆ Four key-on wake-up pins
- ◆ LCD driver/controller
  - Built-in voltage booster for LCD driver
  - With display memory
  - LCD direct drive capability (Max 32 seg × 4 com)
  - 1/4, 1/3, 1/2 duties or static drive are programmably selectable
- ◆ Dual clock operation
  - Single/Dual-clock mode
- ◆ Nine power saving operating modes
  - STOP mode: Oscillation stops. Battery/Capacitor back-up. Port output hold/High-impedance.
  - SLOW 1, 2 modes: Low power consumption operation using low-frequency clock (32.768 kHz)
  - IDLE 0 mode: CPU stops, and peripherals operate using high-frequency clock of Time-Base-Timer. Release by falling edge of TBTCR < TBTCCK > setting.
  - IDLE 1 mode: CPU stops, and peripherals operate using high-frequency clock. Release by interrupts.
  - IDLE 2 mode: CPU stops, and peripherals operate using high and low frequency clock. Release by interrupts.
  - SLEEP 0 mode: CPU stops, and peripherals operate using low-frequency clock of Time-Base-Timer. Release by falling edge of TBTCR < TBTCCK > setting.
  - SLEEP 1 mode: CPU stops, and peripherals operate using low-frequency clock. Release by interrupts.
  - SLEEP 2 mode: CPU stops, and peripherals operate using high and low frequency clock. Release by interrupts.
- ◆ Wide operating voltage: 1.8 to 5.5 V at 4.2 MHz/32.768 kHz,  
2.7 to 5.5 V at 8 MHz/32.768 kHz,  
4.2 to 5.5 V at 16 MHz/32.768 kHz

Pin Assignments (Top View)

P-LQFP64-1010-0.50  
 P-QFP64-1414-0.80A

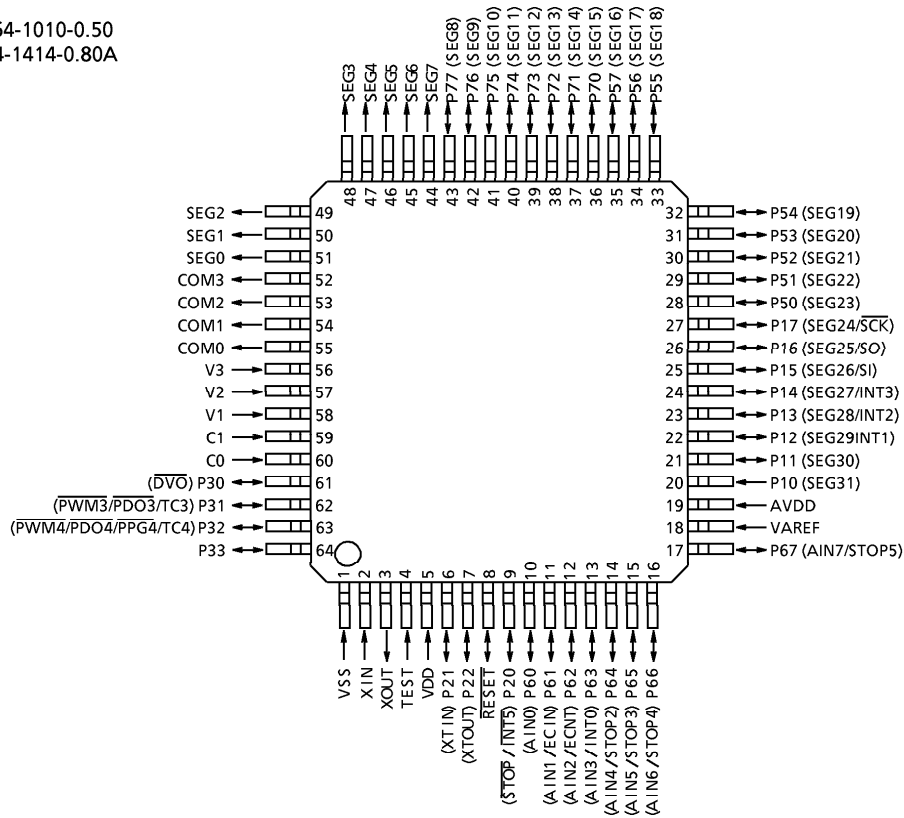

Block Diagram

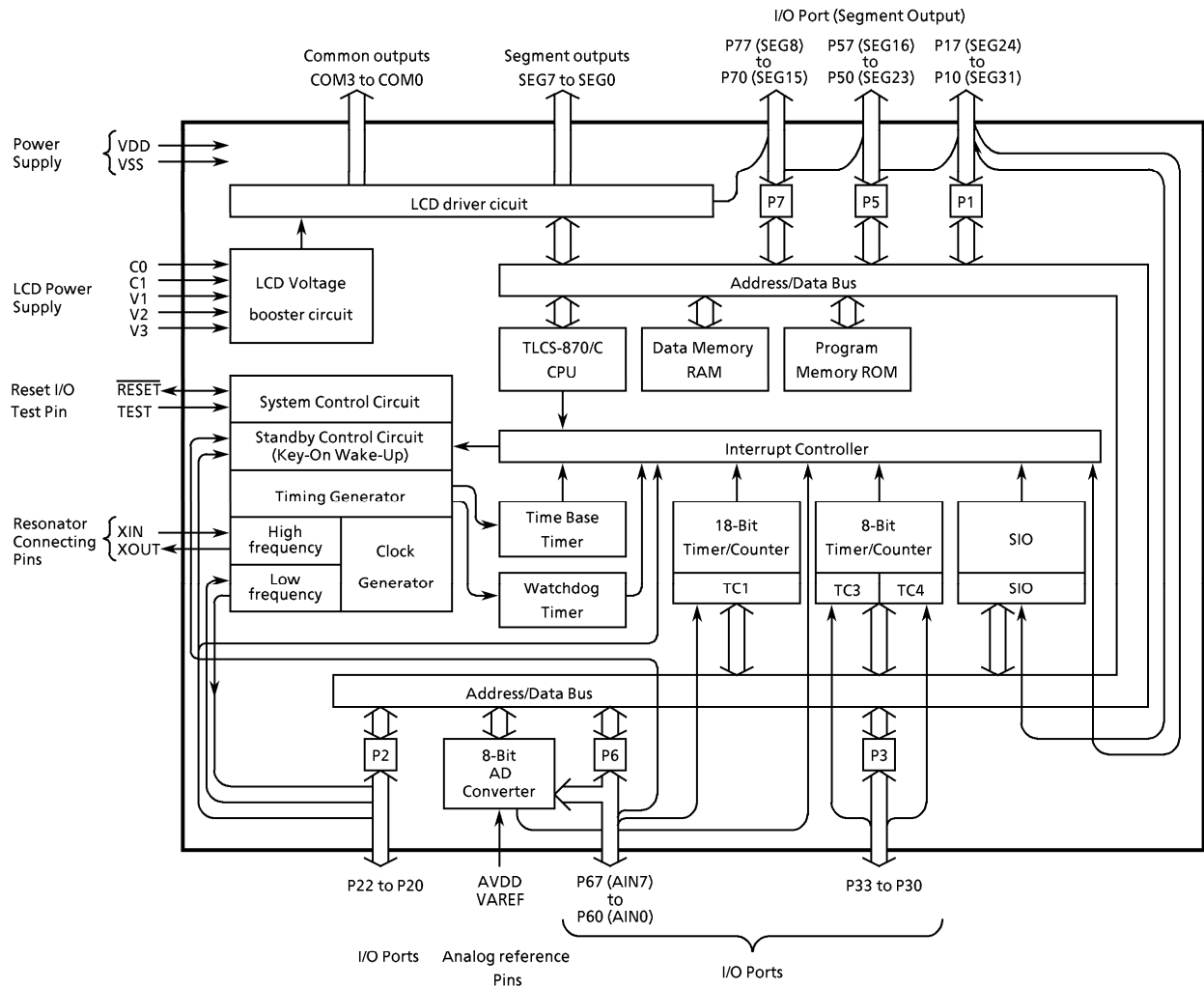

## Pin Function

Pin Name	Input/Output	Function		
P17 (SEG24, $\overline{SCK}$ )	I/O (I/O)	8-bit input/output port with latch. When used as input port, an external interrupt input or serial interface input/output, the P1LCR must be cleared to "0" after setting output latch to "1". When used as a LCD segment output, the P1LCR must be set to "1".	Serial clock input/output	LCD segment outputs.
P16 (SEG25, SO)	I/O (Output)		Serial data input	
P15 (SEG26, SI)	I/O (I/O)		Serial data input	
P14 (SEG27, INT3)	I/O (I/O)		External interrupt 3 input	
P13 (SEG28, INT2)	I/O (I/O)		External interrupt 2 input	
P12 (SEG29, INT1)	I/O (I/O)		External interrupt 1 input	
P11 (SEG30)	I/O (Output)			
P10 (SEG31)	I/O (Output)			
P22 (XTOUT)	I/O (Output)	3-bit input/output port with latch. When used as an input port, the output latch must be set to "1".	Resonator connecting pins (32.768 kHz) For inputting external clock, XTIN is used and XTOUT is opened.	
P21 (XTIN)	I/O (Input)		External interrupt input 5 or STOP mode release signal input	
P20 (INT5, STOP)	I/O (Input)			
P33	I/O	4-bit programmable input/output port (Nch high current output). When used as a timer/counter output or divider output, the output latch must be set to "1". When used as an input port or timer/counter input, the P3OUTCR must be cleared to "0" after P3DR is set to "1".	Timer counter 4 input/output	
P32 (PWM4, PDO4, PPG4, TC4)	I/O(I/O)		Timer counter 3 input/output	
P31 (PWM3, PDO3, TC3)	I/O(I/O)		Divider output	
P30 (DVO)	I/O(Output)			
P57 (SEG16) to P50 (SEG23)	I/O (Output)	8-bit input/output port with latch. When used as a LCD segment output, the P5LCR must be set to "1".	LCD segment outputs	
P67 (AIN7, STOP5)	I/O (Input)	8-bit programmable input/output port (tri-state). Each bit of this port can be individually configured as an input or an output under software control. When used as an analog input, the P6CR must be cleared to "0" after clearing output latch to "0". When used as an input port, a key on wake up input, an external interrupt input and timer/counter input, the P6CR must be cleared to "0" after setting output latch to "1".	STOP 5 input	AD converter analog inputs
P66 (AIN6, STOP4)	I/O (Input)		STOP 4 input	
P65 (AIN5, STOP3)	I/O (Input)		STOP 3 input	
P64 (AIN4, STOP2)	I/O (Input)		STOP 2 input	
P63 (AIN3, INT0)	I/O (Input)		External interrupt 0 input	
P62 (AIN2, ECNT)	I/O (Input)		Timer/counter 1 input	
P61 (AIN1, ECIN)	I/O (Input)			
P60 (AIN0)	I/O (Input)			
P77 (SEG8) to P70 (SEG15)	I/O (Output)	8-bit input/output port with latch. When used as a LCD segment output, the P7LCR must be set to "1".	LCD segment outputs	
SEG7 to SEG0	Output	LCD segment outputs		
COM3 to COM0		LCD common outputs		
V3 to V1 C1 to C0	LCD voltage booster pin	LCD voltage booster pin. Capacitors are required between C0 and C1 pin and V1/V2/V3 pin and GND.		
XIN, XOUT	Input Output	Resonator connecting pins for high-frequency clock. For inputting external clock, XIN is used and XOUT is opened.		
RESET	I/O	Reset signal input or watchdog timer output/address-trap-reset output		
TEST	Input	Test pin for out-going test. Be fixed to low.		
VDD, VSS	Power Supply	+ 5 V, 0 (GND)		
VAREF		Analog reference voltage inputs (High)		
AVDD		AD circuit power supply		

## Operational Description

### 1. CPU Core Functions

The CPU core consists of a CPU, a system clock controller, and an interrupt controller.

This section provides a description of the CPU core, the program memory, the data memory, the external memory interface, and the reset circuit.

#### 1.1 Memory Address Map

The TMP86C420/820 memory consist of 4 blocks: ROM, RAM, DBR (Data Buffer Register) and SFR (Special Function Register). They are all mapped in 64-Kbyte address space. Figure 1-1 shows the TMP86C420/820 memory address map. The general-purpose registers are not assigned to the RAM address space.

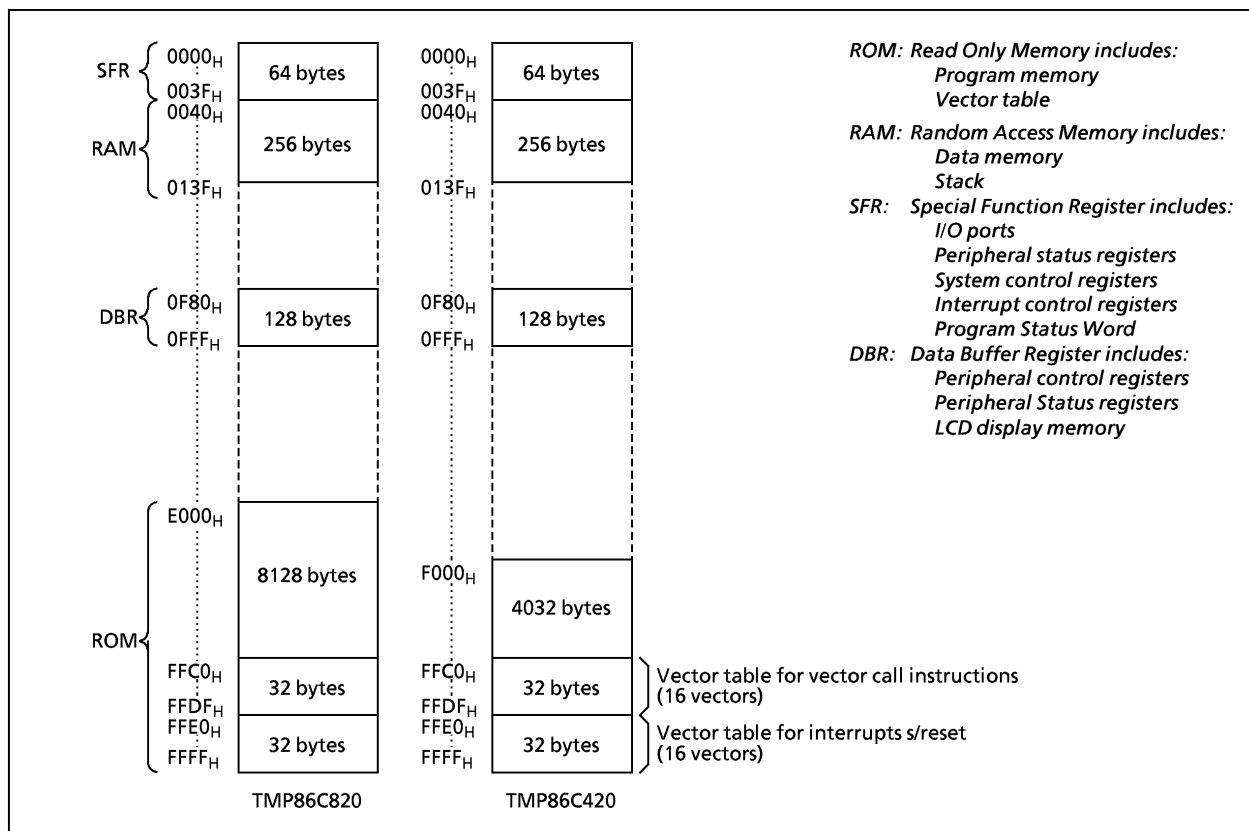

Figure 1-1. Memory Address Maps

#### 1.2 Program Memory (ROM)

The TMP86C420 has a 4 K×8 bits (address F000<sub>H</sub> to FFFF<sub>H</sub>), TMP86C820 has a 8 K×8 bits (address E000<sub>H</sub> to FFFF<sub>H</sub>) of program memory (mask programmed ROM). However, placing program memory on the internal RAM is deregulated if a certain procedure is executed (See 2.4.5 Address trap).

## Electrical Characteristics

## Absolute Maximum Ratings

 $(V_{SS} = 0\text{ V})$ 

Parameter	Symbol	Pins	Rating	Unit
Supply Voltage	$V_{DD}$		- 0.3 to 6.5	V
Input Voltage	$V_{IN}$		- 0.3 to $V_{DD} + 0.3$	
Output Voltage	$V_{OUT1}$		- 0.3 to $V_{DD} + 0.3$	
Output Current (Per 1 pin)	$I_{OUT1}$	P3, P6 Port	- 1.8	mA
	$I_{OUT2}$	P1, P2, P5, P6, P7 Port	3.2	
	$I_{OUT3}$	P3 Port	30	
Output Current (Total)	$\Sigma I_{OUT2}$	P1, P2, P5, P6, P7 Port	60	
	$\Sigma I_{OUT3}$	P3 Port	80	
Power Dissipation [ $T_{opr} = 85^{\circ}\text{C}$ ]	PD		350	
Soldering Temperature (time)	$T_{sld}$		260 (10 s)	$^{\circ}\text{C}$
Storage Temperature	$T_{stg}$		- 55 to 125	
Operating Temperature	$T_{opr}$		- 40 to 85	

*Note: The absolute maximum ratings are rated values which must not be exceeded during operation, even for an instant. Any one of the ratings must not be exceeded. If any absolute maximum rating is exceeded, a device may break down or its performance may be degraded, causing it to catch fire or explode resulting in injury to the user. Thus, when designing products which include this device, ensure that no absolute maximum rating value will ever be exceeded.*

Recommended Operating Condition	( $V_{SS} = 0\text{ V}$ , $T_{opr} = -40\text{ to }85^{\circ}\text{C}$ )
---------------------------------	--

Parameter	Symbol	Pins	Condition	Min	Max	Unit	
Supply Voltage	$V_{DD}$		$f_c = 16\text{ MHz}$	NORMAL1, 2 modes	4.5	5.5	V
				IDLE0, 1, 2 modes			
			$f_c = 8\text{ MHz}$	NORMAL1, 2 modes	2.7		
				IDLE0, 1, 2 modes			
			$f_c = 4.2\text{ MHz}$	NORMAL1, 2 modes	1.8		
				IDLE0, 1, 2 modes			
$f_s = 32.768\text{ kHz}$	SLOW1, 2 modes	1.8					
	SLEEP0, 1, 2 modes						
	STOP mode						
Input high Level	$V_{IH1}$	Except Hysteresis input	$V_{DD} \geq 4.5\text{ V}$	$V_{DD} \times 0.70$	$V_{DD}$		
	$V_{IH2}$	Hysteresis input		$V_{DD} \times 0.75$			
	$V_{IH3}$			$V_{DD} < 4.5\text{ V}$			$V_{DD} \times 0.90$
Input low Level	$V_{IL1}$	Except Hysteresis input	$V_{DD} \geq 4.5\text{ V}$	0	$V_{DD} \times 0.30$		
	$V_{IL2}$	Hysteresis input			$V_{DD} \times 0.25$		
	$V_{IL3}$				$V_{DD} < 4.5\text{ V}$		$V_{DD} \times 0.10$
Clock Frequency	$f_c$	XIN, XOUT	$V_{DD} = 1.8\text{ to }5.5\text{ V}$	1.0	4.2	MHz	
			$V_{DD} = 2.7\text{ to }5.5\text{ V}$		8.0		
			$V_{DD} = 4.5\text{ to }5.5\text{ V}$		16.0		
	$f_s$	XTIN, XTOUT		30.0	34.0	kHz	

*Note: The recommended operating conditions for a device are operating conditions under which it can be guaranteed that the device will operate as specified. If the device is used under operating conditions other than the recommended operating conditions (supply voltage, operating temperature range, specified AC/DC values etc.), malfunction may occur. Thus, when designing products which include this device, ensure that the recommended operating conditions for the device are always adhered to.*



DC Characteristics (V<sub>SS</sub> = 0 V, T<sub>opr</sub> = -40 to 85°C)

Parameter	Symbol	Pins	Condition	Min	Typ.	Max	Unit
Hysteresis Voltage	V <sub>HS</sub>	Hysteresis input		-	0.9	-	V
Input Current	I <sub>IN1</sub>	TEST	V <sub>DD</sub> = 5.5 V, V <sub>IN</sub> = 5.5 V/0 V	-	-	± 2	μA
	I <sub>IN2</sub>	Sink Open Drain, Tri-state					
	I <sub>IN3</sub>	RESET, STOP					
Input Resistance	R <sub>IN1</sub>	TEST Pull-Down		-	70	-	kΩ
	R <sub>IN2</sub>	RESET Pull-Up		100	220	450	
Output Leakage Current	I <sub>LO</sub>	Sink Open Drain, Tri-state	V <sub>DD</sub> = 5.5 V, V <sub>OUT</sub> = 5.5 V/0 V	-	-	± 2	μA
Output High Voltage	V <sub>OH2</sub>	C-MOS, Tri-st Port	V <sub>DD</sub> = 4.5 V, I <sub>OH</sub> = -0.7 mA	4.1	-	-	V
Output Low Voltage	V <sub>OL</sub>	Except XOUT and P3 Port	V <sub>DD</sub> = 4.5 V, I <sub>OL</sub> = 1.6 mA	-	-	0.4	
Output Low Current	I <sub>OL</sub>	High Current Port (P3 Port)	V <sub>DD</sub> = 4.5 V, V <sub>OL</sub> = 1.0 V	-	20	-	mA
Supply Current in NORMAL 1, 2 modes	I <sub>DD</sub>		V <sub>DD</sub> = 5.5 V V <sub>IN</sub> = 5.3/0.2 V	-	7.5	9	
Supply Current in IDLE 0, 1, 2 modes			f <sub>c</sub> = 16 MHz f <sub>s</sub> = 32.768 kHz	-	5.5	6.5	
Supply Current in SLOW 1 mode			V <sub>DD</sub> = 3.0 V V <sub>IN</sub> = 2.8 V/0.2 V f <sub>s</sub> = 32.768 kHz LCD driver is not enable.	-	18	42	
Supply Current in SLEEP 1 mode				-	16	25	
Supply Current in SLEEP 0 mode				-	12	20	
Supply Current in STOP mode				V <sub>DD</sub> = 5.5 V V <sub>IN</sub> = 5.3 V/0.2 V	-	0.5	10

Note 1: Typical values show those at T<sub>opr</sub> = 25°C, V<sub>DD</sub> = 5 V

Note 2: Input current (I<sub>IN1</sub>, I<sub>IN2</sub>): The current through pull-up or pull-down resistor is not included.

Note 3: I<sub>DD</sub> does not include I<sub>REF</sub> current.

Note 4: The supply currents of SLOW 2 and SLEEP 2 modes are equivalent to IDLE 0, 1, 2.

## AD Conversion Characteristics

(V<sub>SS</sub> = 0.0 V, 4.5 V ≤ V<sub>DD</sub> ≤ 5.5 V, Topr = -40 to 85°C)

Parameter	Symbol	Condition	Min	Typ.	Max	Unit
Analog Reference Voltage	V <sub>AREF</sub>		A <sub>VDD</sub> - 1.5	-	A <sub>VDD</sub>	V
Power Supply Voltage of Analog Control Circuit	A <sub>VDD</sub>		V <sub>DD</sub>			
Analog Reference Voltage Range (Note 4)	ΔV <sub>AREF</sub>		3.0	-	-	
Analog Input Voltage	V <sub>AIN</sub>		V <sub>SS</sub>	-	V <sub>AREF</sub>	
Power Supply Current of Analog Reference Voltage	I <sub>REF</sub>	V <sub>DD</sub> = A <sub>VDD</sub> = V <sub>AREF</sub> = 5.5 V V <sub>SS</sub> = 0.0 V	-	0.6	1.0	mA
Non linearity Error		V <sub>DD</sub> = A <sub>VDD</sub> = 5.0 V, V <sub>SS</sub> = 0.0 V V <sub>AREF</sub> = 5.0 V	-	-	± 1	LSB
Zero Point Error			-	-	± 1	
Full Scale Error			-	-	± 1	
Total Error			-	-	± 2	

(V<sub>SS</sub> = 0.0 V, 2.7 V ≤ V<sub>DD</sub> < 4.5 V, Topr = -40 to 85°C)

Parameter	Symbol	Condition	Min	Typ.	Max	Unit
Analog Reference Voltage	V <sub>AREF</sub>		A <sub>VDD</sub> - 1.5	-	A <sub>VDD</sub>	V
Power Supply Voltage of Analog Control Circuit	A <sub>VDD</sub>		V <sub>DD</sub>			
Analog Reference Voltage Range (Note 4)	ΔV <sub>AREF</sub>		2.5	-	-	
Analog Input Voltage	V <sub>AIN</sub>		V <sub>SS</sub>	-	V <sub>AREF</sub>	
Power Supply Current of Analog Reference Voltage	I <sub>REF</sub>	V <sub>DD</sub> = A <sub>VDD</sub> = V <sub>AREF</sub> = 4.5 V V <sub>SS</sub> = 0.0 V	-	0.5	0.8	mA
Non linearity Error		V <sub>DD</sub> = A <sub>VDD</sub> = 2.7 V, V <sub>SS</sub> = 0.0 V V <sub>AREF</sub> = 2.7 V	-	-	± 1	LSB
Zero Point Error			-	-	± 1	
Full Scale Error			-	-	± 1	
Total Error			-	-	± 2	

(V<sub>SS</sub> = 0.0 V, 2.0 V ≤ V<sub>DD</sub> < 2.7 V, Topr = -40 to 85°C) Note 5(V<sub>SS</sub> = 0.0 V, 1.8 V ≤ V<sub>DD</sub> < 2.0 V, Topr = -10 to 85°C) Note 5

Parameter	Symbol	Condition	Min	Typ.	Max	Unit
Analog Reference Voltage	V <sub>AREF</sub>		A <sub>VDD</sub> - 0.9	-	A <sub>VDD</sub>	V
Power Supply Voltage of Analog Control Circuit	A <sub>VDD</sub>		V <sub>DD</sub>			
Analog Reference Voltage Range (Note 4)	ΔV <sub>AREF</sub>	1.8 V ≤ V <sub>DD</sub> < 2.0 V	1.8	-	-	
		2.0 V ≤ V <sub>DD</sub> < 2.7 V	2.0	-	-	
Analog Input Voltage	V <sub>AIN</sub>		V <sub>SS</sub>	-	V <sub>AREF</sub>	
Power Supply Current of Analog Reference Voltage	I <sub>REF</sub>	V <sub>DD</sub> = A <sub>VDD</sub> = V <sub>AREF</sub> = 2.7 V V <sub>SS</sub> = 0.0 V	-	0.3	0.5	mA
Non linearity Error		V <sub>DD</sub> = A <sub>VDD</sub> = 1.8 V, V <sub>SS</sub> = 0.0 V V <sub>AREF</sub> = 1.8 V	-	-	± 2	LSB
Zero Point Error			-	-	± 2	
Full Scale Error			-	-	± 2	
Total Error			-	-	± 4	

Note 1: The total error includes all errors except a quantization error, and is defined as a maximum deviation from the ideal conversion line.

Note 2: Conversion time is different in recommended value by power supply voltage.  
About conversion time, please refer to "2.9.2 Register Configuration".

Note 3: Please use input voltage to AIN input Pin in limit of V<sub>AREF</sub> - V<sub>SS</sub>.  
When voltage of range outside is input, conversion value becomes unsettled and gives affect to other channel conversion value.

Note 4: Analog Reference Voltage Range: ΔV<sub>AREF</sub> = V<sub>AREF</sub> - V<sub>SS</sub>

Note 5: When AD is used with V<sub>DD</sub> < 2.7 V, the guaranteed temperature range varies with the operating voltage.

Note 6: The A<sub>VDD</sub> pin should be fixed on the V<sub>DD</sub> level even though AD convertor is not used.

## AC Characteristics

 $(V_{SS} = 0\text{ V}, V_{DD} = 4.5\text{ to }5.5\text{ V}, T_{opr} = -40\text{ to }85^{\circ}\text{C})$ 

Parameter	Symbol	Condition	Min	Typ.	Max	Unit
Machine Cycle Time	tcy	NORMAL 1, 2 modes	0.25	-	4	$\mu\text{s}$
		IDLE 1, 2 modes				
		SLOW 1, 2 modes	117.6	-	133.3	
		SLEEP 1, 2 modes				
High Level Clock Pulse Width	twcH	For external clock operation (XIN input)	-	31.25	-	ns
Low Level Clock Pulse Width	twcL	fc = 16 MHz	-	31.25	-	ns
High Level Clock Pulse Width	twcH	For external clock operation (XTIN input)	-	15.26	-	$\mu\text{s}$
Low Level Clock Pulse Width	twcL	fc = 32.768 kHz	-	15.26	-	$\mu\text{s}$

 $(V_{SS} = 0\text{ V}, V_{DD} = 2.7\text{ to }4.5\text{ V}, T_{opr} = -40\text{ to }85^{\circ}\text{C})$ 

Parameter	Symbol	Condition	Min	Typ.	Max	Unit
Machine Cycle Time	tcy	NORMAL 1, 2 modes	0.5	-	4	$\mu\text{s}$
		IDLE 1, 2 modes				
		SLOW 1, 2 modes	117.6	-	133.3	
		SLEEP 1, 2 modes				
High Level Clock Pulse Width	twcH	For external clock operation (XIN input)	-	62.5	-	ns
Low Level Clock Pulse Width	twcL	fc = 8 MHz	-	62.5	-	ns
High Level Clock Pulse Width	twcH	For external clock operation (XTIN input)	-	15.26	-	$\mu\text{s}$
Low Level Clock Pulse Width	twcL	fc = 32.768 kHz	-	15.26	-	$\mu\text{s}$

 $(V_{SS} = 0\text{ V}, V_{DD} = 1.8\text{ to }2.7\text{ V}, T_{opr} = -40\text{ to }85^{\circ}\text{C})$ 

Parameter	Symbol	Condition	Min	Typ.	Max	Unit
Machine Cycle Time	tcy	NORMAL 1, 2 modes	0.95	-	4	$\mu\text{s}$
		IDLE 1, 2 modes				
		SLOW 1, 2 modes	117.6	-	133.3	
		SLEEP 1, 2 modes				
High Level Clock Pulse Width	twcH	For external clock operation (XIN input)	-	119.05	-	ns
Low Level Clock Pulse Width	twcL	fc = 4.2 MHz	-	119.05	-	ns
High Level Clock Pulse Width	twcH	For external clock operation (XTIN input)	-	15.26	-	$\mu\text{s}$
Low Level Clock Pulse Width	twcL	fc = 32.768 kHz	-	15.26	-	$\mu\text{s}$

## Timer Counter 1 input (ECIN) Characteristics

 $(V_{SS} = 0\text{ V}, T_{opr} = -40\text{ to }85^{\circ}\text{C})$ 

Parameter	Symbol	Condition	Min	Typ.	Max	Unit	
TC1 input (ECIN input)	$t_{TC1}$	Frequency measurement mode $V_{DD} = 4.5\text{ to }5.5\text{ V}$	Single edge count	-	-	16	MHz
		Frequency measurement mode $V_{DD} = 2.7\text{ to }4.5\text{ V}$	Single edge count	-	-	8	
		Frequency measurement mode $V_{DD} = 1.8\text{ to }2.7\text{ V}$	Single edge count	-	-	4.2	

## Recommended Oscillating Conditions - 1

 $(V_{SS} = 0\text{ V}, V_{DD} = 4.5\text{ to }5.5\text{ V}, T_{opr} = -40\text{ to }85^{\circ}\text{C})$ 

PARAMETER	Oscillator	Oscillation Frequency	Recommended Oscillator		Recommended Constant	
					C <sub>1</sub>	C <sub>2</sub>
High-frequency Oscillation	Ceramic Resonator	16 MHz	MURATA	CSA16.00MXZ040	10 pF	10 pF
		8 MHz	MURATA	CSA8.00MTZ	30 pF	30 pF
				CST8.00MTW	30 pF (built-in)	30 pF (built-in)
		4.19 MHz	MURATA	CSA4.19MG	30 pF	30 pF
				CST4.19MGW	30 pF (built-in)	30 pF (built-in)
Low-frequency Oscillation	Crystal Oscillator	32.768 kHz	SII	VT-200	6 pF	6 pF

## Recommended Oscillating Conditions - 2

 $(V_{SS} = 0\text{ V}, V_{DD} = 2.7\text{ to }5.5\text{ V}, T_{opr} = -40\text{ to }85^{\circ}\text{C})$ 

PARAMETER	Oscillator	Oscillation Frequency	Recommended Oscillator		Recommended Constant	
					C <sub>1</sub>	C <sub>2</sub>
High-frequency Oscillation	Ceramic Resonator	8 MHz	MURATA	CSA8.00MTZ	30 pF	30 pF
				CST8.00MTW	30 pF (built-in)	30 pF (built-in)
		4.19 MHz	MURATA	CSA4.19MG	30 pF	30 pF
				CST4.19MGW	30 pF (built-in)	30 pF (built-in)

## Recommended Oscillating Conditions - 3

 $(V_{SS} = 0\text{ V}, V_{DD} = 1.8\text{ to }5.5\text{ V}, T_{opr} = -40\text{ to }85^{\circ}\text{C})$ 

PARAMETER	Oscillator	Oscillation Frequency	Recommended Oscillator		Recommended Constant	
					C <sub>1</sub>	C <sub>2</sub>
High-frequency Oscillation	Ceramic Resonator	4.19 MHz	MURATA	CSA4.19MG	30 pF	30 pF
				CST4.19MGW	30 pF (built-in)	30 pF (built-in)

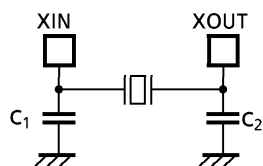

(1) High-frequency Oscillation

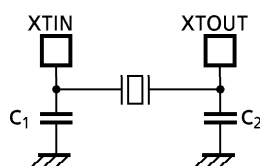

(2) Low-frequency Oscillation

**Note 1:** An electrical shield by metal shield plate on the surface of IC package is recommended in order to protect the device from the high electric field stress applied from CRT (Cathodic Ray Tube) for continuous reliable operation.

**Note 2:** The product numbers and specifications of the resonators by Murata Manufacturing Co., Ltd. are subject to change.

For up-to-date information, please refer to the following URL:

<http://www.murata.co.jp/search/index.html>