



LA6393M

High-Performance Dual Comparator

Overview

The LA6393M is a high-performance dual comparator that is capable of operating from a single power supply over a wide range of 2V to 36V. Because of its excellent input characteristics and low power, it can be very conveniently applied to multisignal parallel comparator circuits that require high-density assembly.

Features

- Wide supply voltage range (Single supply : 2.0 to 36.0V, dual supplies : ± 1.0 to 18.0V).
- Wide common-mode input voltage range (0 to $V_{CC}-1.5V$).
- Open collector output enabling wired OR.
- Small current drain (0.6mA) and low power.
- Mini flat package enabling compactness of sets.

Specifications

Absolute Maximum Ratings at $T_a = 25^\circ C$

Parameter	Symbol	Conditions	Ratings	Unit
Maximum supply voltage	$V_{CC\ max}$		36	V
Differential input voltage	V_{ID}		36	V
Common-mode input voltage range	V_{ICM}		-0.3 to +36	V
Allowable power dissipation	$P_d\ max$		300	mW
Operating temperature	T_{opr}		-30 to +85	$^\circ C$
Storage temperature	T_{stg}		-55 to +125	$^\circ C$

Operating Characteristics at $T_a = 25^\circ C$, $V_{CC}=5V$

Parameter	Symbol	Conditions	Test Circuit	Ratings			Unit
				min	typ	max	
Input offset voltage	V_{IO}		1		± 1	± 5	mV
Input offset current	I_{IO}		2		± 5	± 50	nA
Input bias current	I_B		3		25	250	nA
Common-mode input voltage range	V_{ICM}			0		$V_{CC}-1.5$	V
Current drain	I_{CC}	$R_L = \infty$	4		0.6	1	mA
Voltage gain	V_G	$R_L = 15k\Omega$	5		200		V/mV
Response time		$V_{RL}=5V$, $R_L=5.1k\Omega$	6		1.3		μs
Output sink current	I_{SINK}	$V_{IN^-}=1V$, $V_{IN^+}=0V$, $V_O \leq 1.5V$	7	6	16		mA
Output saturation voltage	V_{OL}	$V_{IN^-}=1V$, $V_{IN^+}=0V$, $I_{SINK} \leq 3mA$	8		0.2	0.4	V
Output leakage current	I_{LEAK}	$V_{IN^-}=0V$, $V_{IN^+}=1V$, $V_O=5V$	9		0.1		nA

■ Any and all SANYO products described or contained herein do not have specifications that can handle applications that require extremely high levels of reliability, such as life-support systems, aircraft's control systems, or other applications whose failure can be reasonably expected to result in serious physical and/or material damage. Consult with your SANYO representative nearest you before using any SANYO products described or contained herein in such applications.

■ SANYO assumes no responsibility for equipment failures that result from using products at values that exceed, even momentarily, rated values (such as maximum ratings, operating condition ranges, or other parameters) listed in products specifications of any and all SANYO products described or contained herein.

Package Dimensions

unit:mm

3032B-MFP8

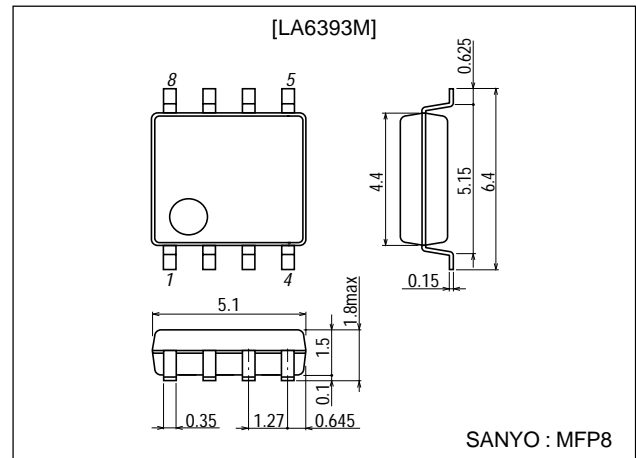

Test Circuits

1. Input offset voltage

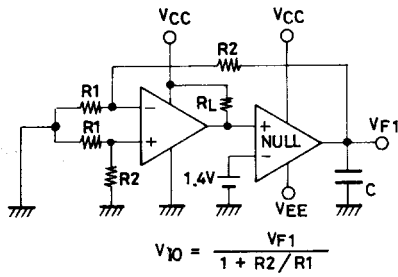

2. Input offset current

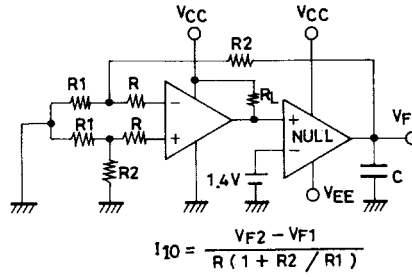

3. Input bias current

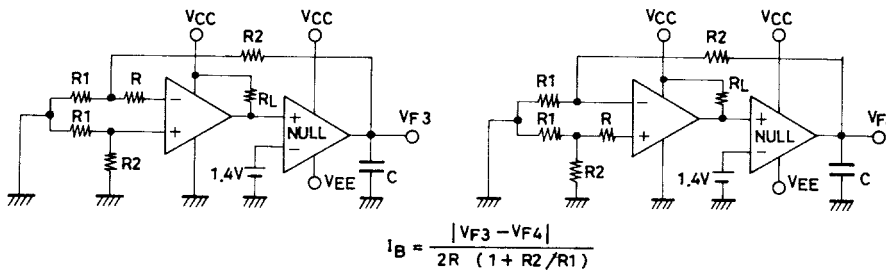

4. Current drain

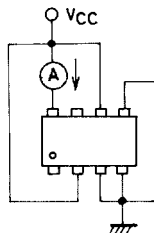

5. Voltage gain

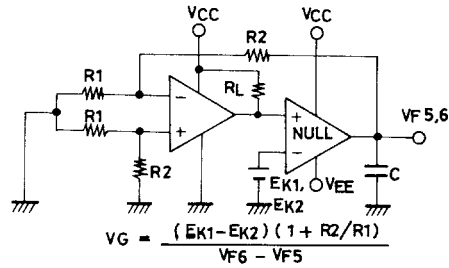

6. Response time

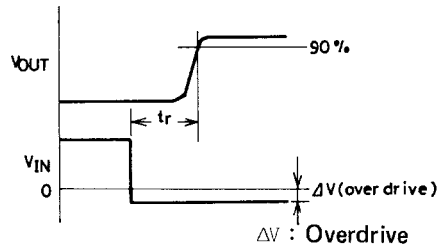
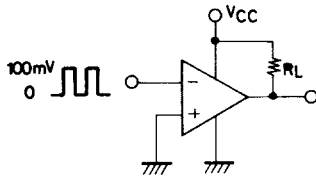

7. Output sink current

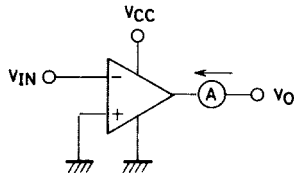

8. Output saturation voltage

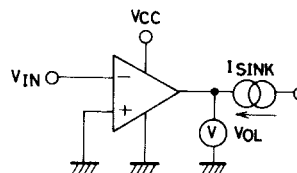

9. Output leakage current

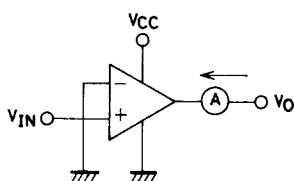

LA6393M

Equivalent Circuit

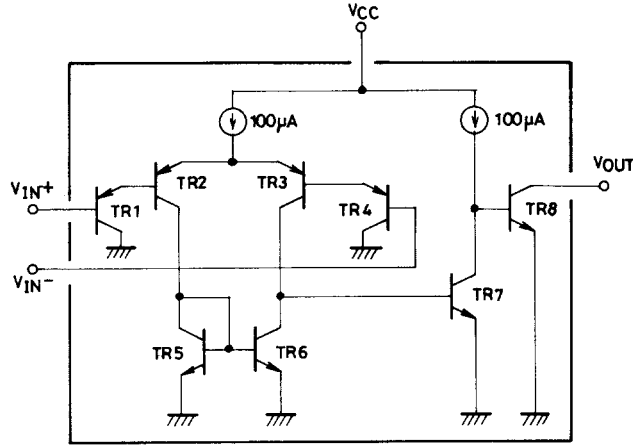

Pin Assignment

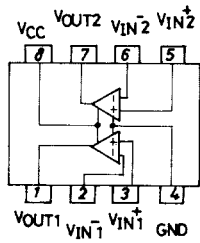

Main Characteristics

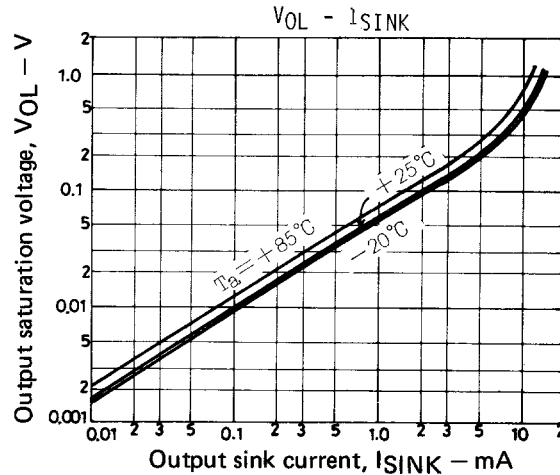
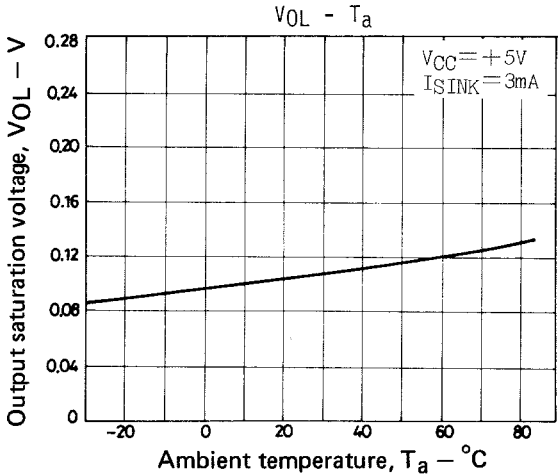
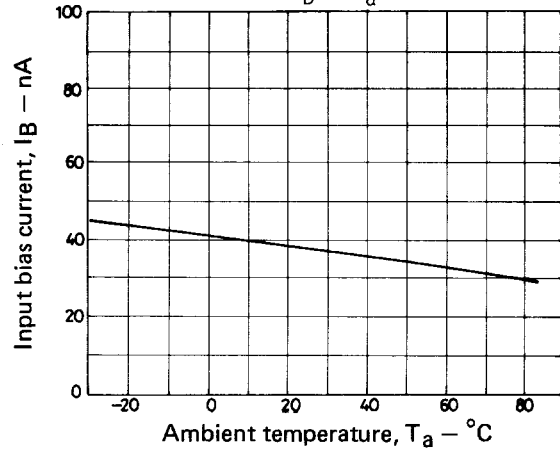
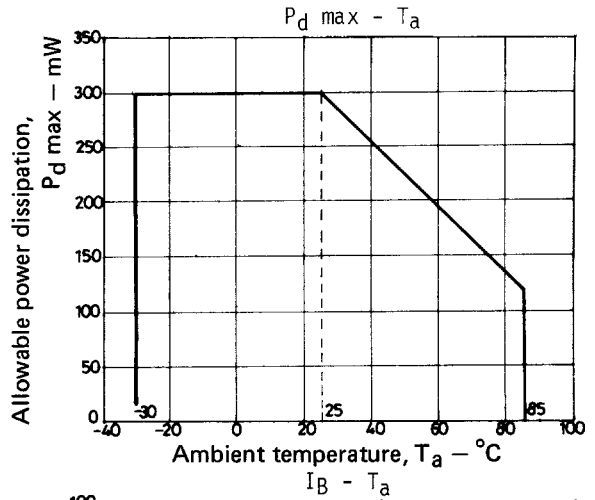
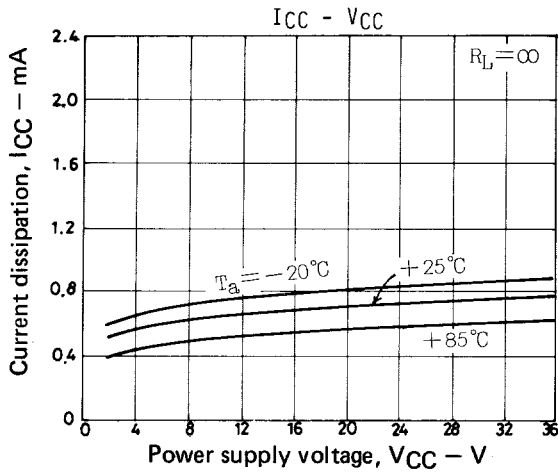

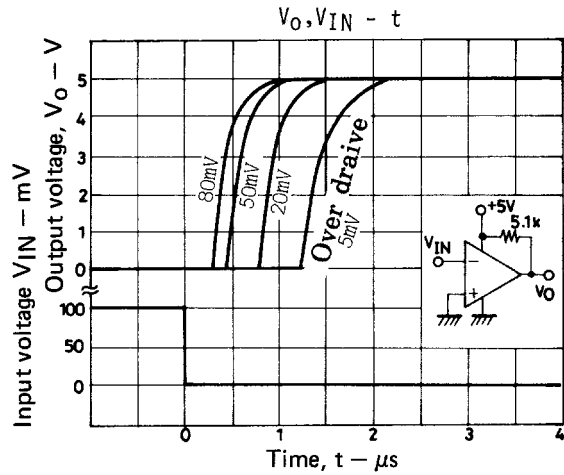
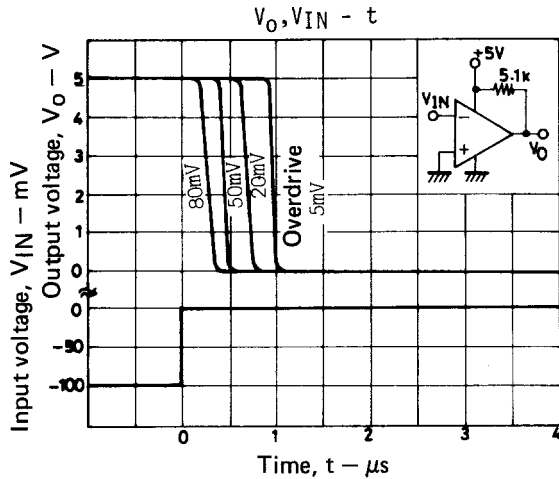

Sample Application Circuits

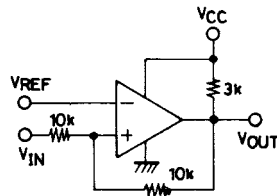

Voltage comparator (with hysteresis)

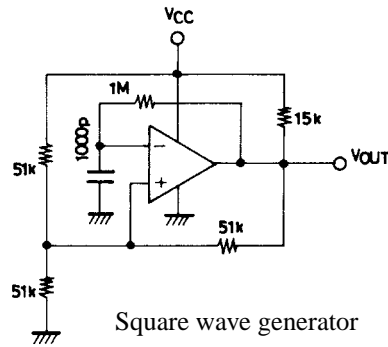

Square wave generator

Unit (resistance: Ω, capacitance: F)

- Specifications of any and all SANYO products described or contained herein stipulate the performance, characteristics, and functions of the described products in the independent state, and are not guarantees of the performance, characteristics, and functions of the described products as mounted in the customer's products or equipment. To verify symptoms and states that cannot be evaluated in an independent device, the customer should always evaluate and test devices mounted in the customer's products or equipment.
- SANYO Electric Co., Ltd. strives to supply high-quality high-reliability products. However, any and all semiconductor products fail with some probability. It is possible that these probabilistic failures could give rise to accidents or events that could endanger human lives, that could give rise to smoke or fire, or that could cause damage to other property. When designing equipment, adopt safety measures so that these kinds of accidents or events cannot occur. Such measures include but are not limited to protective circuits and error prevention circuits for safe design, redundant design, and structural design.
- In the event that any or all SANYO products(including technical data, services) described or contained herein are controlled under any of applicable local export control laws and regulations, such products must not be exported without obtaining the export license from the authorities concerned in accordance with the above law.
- No part of this publication may be reproduced or transmitted in any form or by any means, electronic or mechanical, including photocopying and recording, or any information storage or retrieval system, or otherwise, without the prior written permission of SANYO Electric Co., Ltd.
- Any and all information described or contained herein are subject to change without notice due to product/technology improvement, etc. When designing equipment, refer to the "Delivery Specification" for the SANYO product that you intend to use.
- Information (including circuit diagrams and circuit parameters) herein is for example only ; it is not guaranteed for volume production. SANYO believes information herein is accurate and reliable, but no guarantees are made or implied regarding its use or any infringements of intellectual property rights or other rights of third parties.

This catalog provides information as of April, 2000. Specifications and information herein are subject to change without notice.