

D4 Series

Miniature

Features

- 8 current ratings
- Choice of actuators
- Various terminal types
- 3 contact arrangements
- Choice of standard or light operating force
- Long life coil spring mechanism
- Agency approved extended life versions
- VDE approved versions available upon request
- Stackable case and cover available upon request

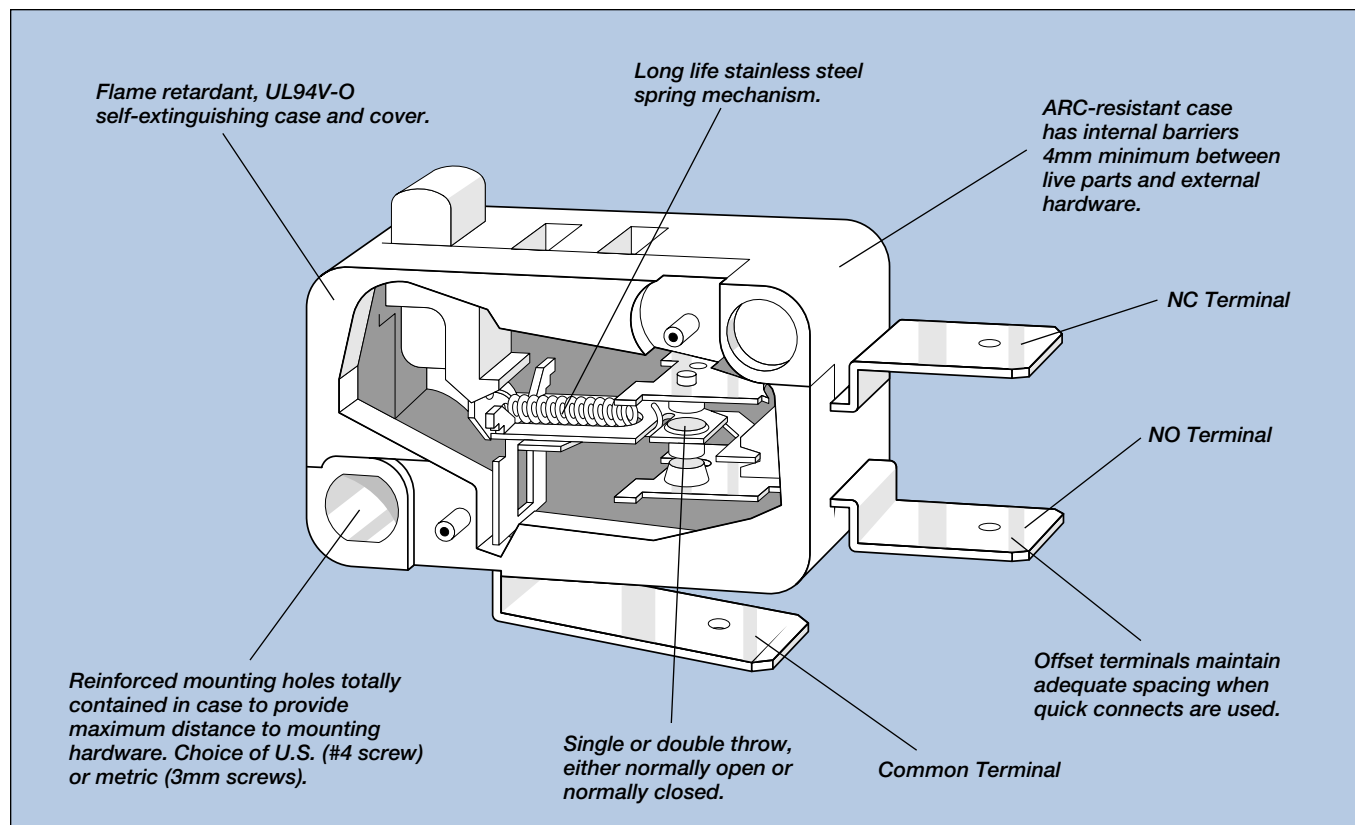
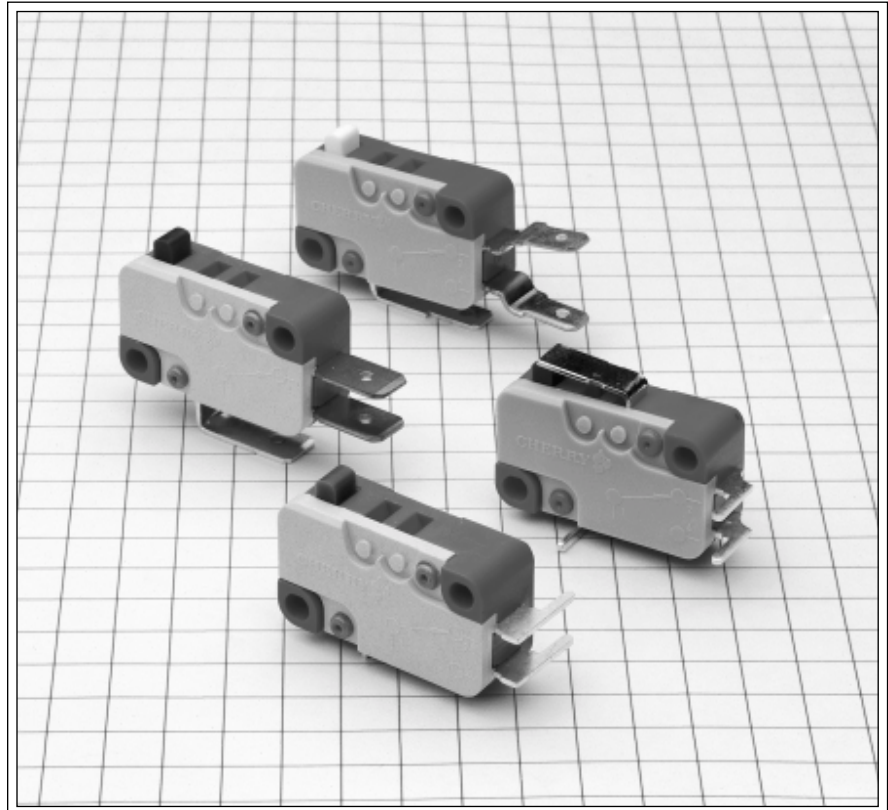

D4 Series

Miniature

Dimensions: mm International Version

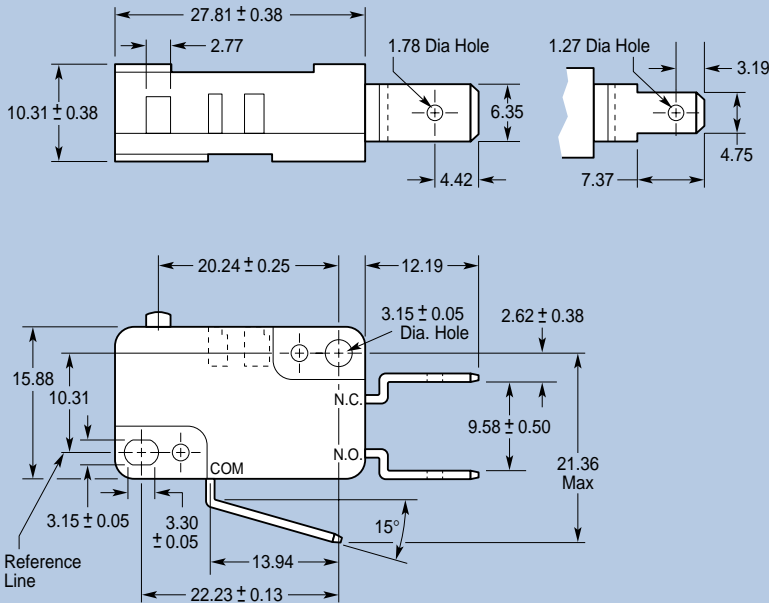

Dimensions: Inches U.S. Version

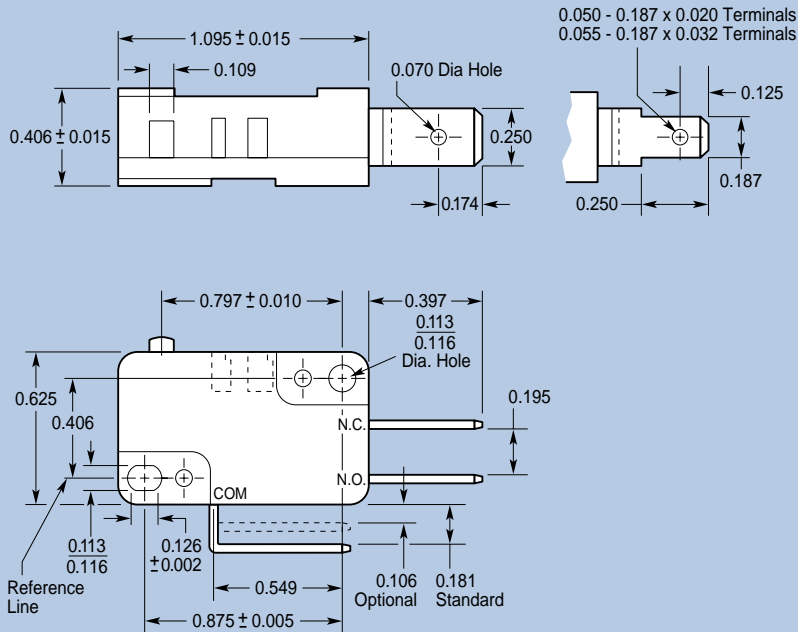

PCB Footprint

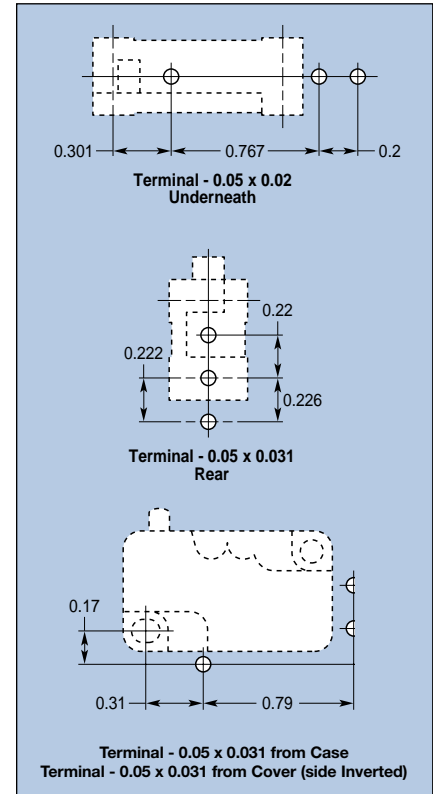

Mounting

Recommended mounting screw size:
#4-40 round head

Recommended torque on screw:
3 inch lbs. max.

Hi-Temperature Versions

4th Digit of Part Number

Mt'g Holes	Temp. Index	Oper. Force	Contact Configuration Code		
			N.O.	N.C.	D.T.
U.S. Mt'g. Holes White Case	T85	Std.	A	B	C
		Light	J	K	L
	T150	Std.	D	E	F
		Light	W	X	Y
Metric Mt'g. Holes Red Case	T85	Std.	1	2	3
		Light	7	8	9
	From German T125 Only	Std.	G	H	M
		Light	N	P	R
	T150	Std.	4	5	6
		Light	S	T	U

D4 Series

Miniature

Two Basic Designs

International Approved Versions

Designations:

Standard Force: Series D413, D423, D433, D443, D453

Light Force: Series D419, D429, D439, D449, D459, D489

These switches have 6.35 mm or 4.75 mm x 0.81 mm thick "offset" terminals and metric mounting holes. They are also available with straight terminals.

U.S. Versions

Designations:

Standard Force: Series D40C, D41C, D42C, D43C, D44C, D45C and D49C

Light Force: Series D40L, D41L, D42L, D43L, D44L, D45L, D48L and D49L

These D4 terminals are "straight" and measure 0.187" x 0.020" thick, 0.187" x 0.032" thick or 0.250" x 0.032" thick.

Contacts and Ratings

Series Prefix	UL & CSA Ratings	Contact Material
D40	1.0 amp, 125 VAC	Gold Crosspoint Contacts
D41*	0.1 amp, 125/250 VAC (UL+CUL) 0.25 amp, 30 VDC	
D42	3 amp, 125/250 VAC	Silver Alloy
D43	5 amp, 1/4 HP 125/250VAC	Silver Alloy
D44	10 amp, 1/2 HP 125/250VAC	Silver Alloy
D45	15 amp, 1/2 HP 125/250 VAC	Silver Alloy
D48	21 amp, 250 VAC 1 HP, 125 VAC 2 HP, 250 VAC	Silver Alloy
D49	10 amp, 1/2 HP 125/250 VAC 6 amp, 30 VDC	Silver Alloy
Temperature Rating	-40° to +85°C, +125°C, and +150°C optional (See selection guide 3-7)	
Flammability Rating	UL94V-O	

*D41 UL and CUL rated

Electrical Specifications/Life

See electrical life chart on page 11-4.

Materials

Case/Cover	Thermoplastic Polyester
Button	Thermoplastic Acetal (T85) Thermoplastic Polyester (T125 & T150)
Auxiliary Actuator	Aluminum, Stainless Steel, or Cold-rolled Steel (Nickel Plated)
Spring	Stainless Steel
Terminals	D41-D44: Brass D45, D48: Copper (NO/NC), Brass (COM)
Moving Blade	D41-D43: Brass D44-D48: Beryllium Copper

Note: Standard material on auxiliary straight actuators used on D40, D41, and D42 is aluminum.

Actuators

Many special forms and lengths of actuators are available. Non-standard type integral hinged lever and roller actuators are available with tooling charges applying. Standard type integral hinged lever and roller actuators are available in choice of two pivot positions. Lengths are dimensioned from centerline of switch upper mounting hole as shown here.

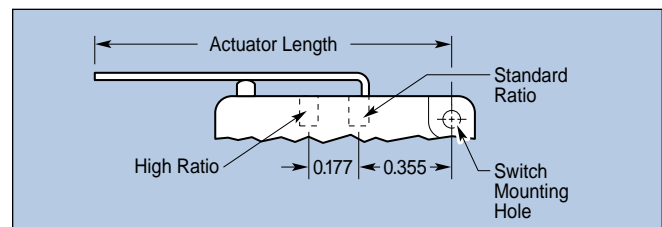

Auxiliary Actuator

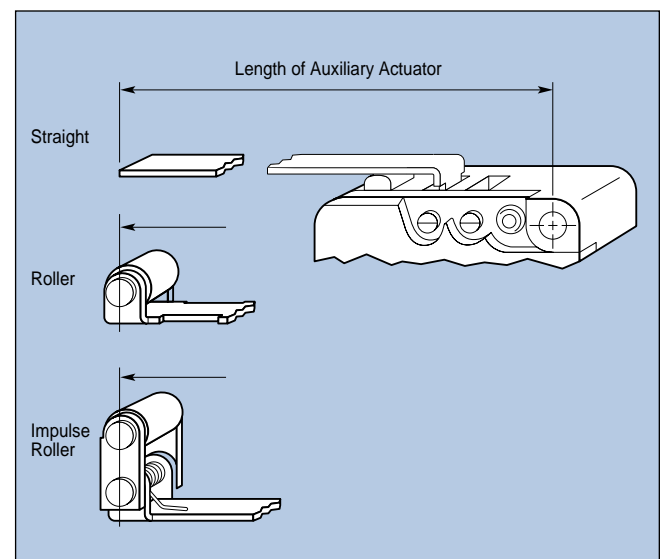

D4 Series

Miniature

Terminals

Choice of two QC terminations: 0.250" (6.35 mm) x 0.032" (0.81 mm) thick "offset" terminals or 0.187" (4.75 mm) x 0.020" (0.50 mm) thick with international as well as UL/CSA approvals.

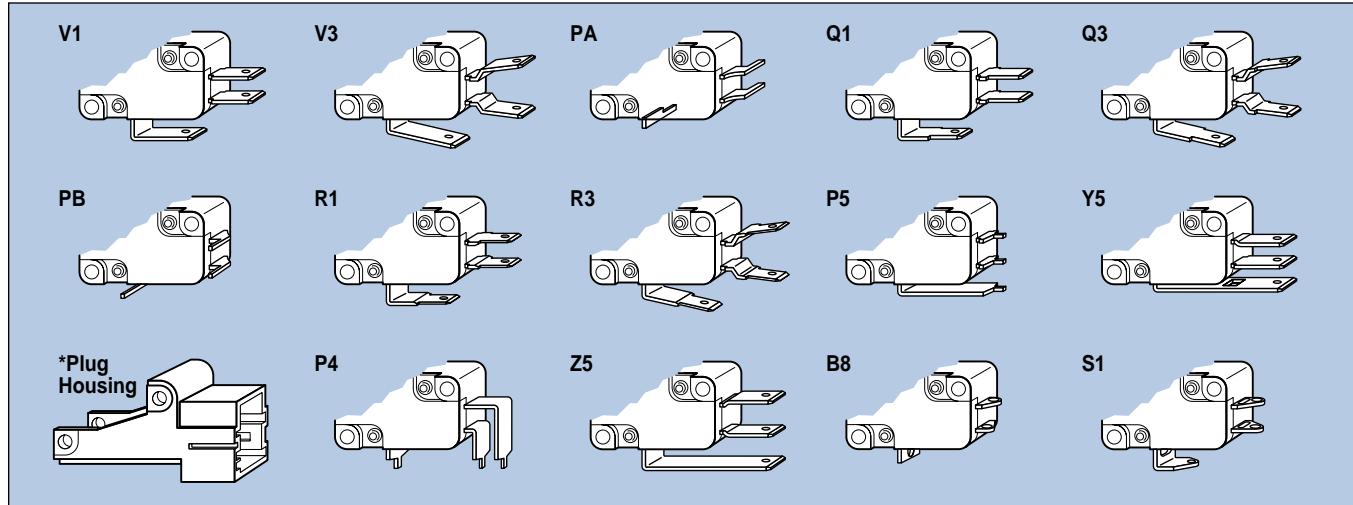
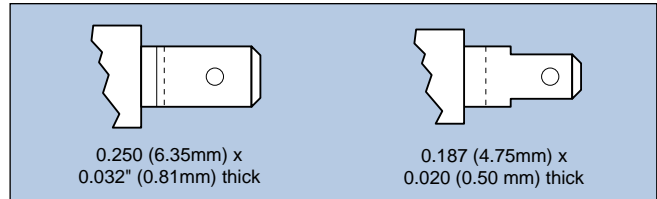

Note: Tolerance on terminals ± 0.003

* Connector part # 623-0518 (mates with Y5 only)

Ordering Information

D4			3			C			Q			1			A			A		
Series/Prefix												CODE Terminal Config.			CODE Actuator			Code Actuator Length		
CODE	VDE	UL	CODE	Mt'g Holes	Oper. Force	Contact Configurations			CODE	Terminal Type	CODE	Terminal Config.	CODE	Actuator	A	D	L			
						N.O.	N.C.	D.T.												
0	-	0.1 amp, 125/250 VAC 0.25A, 30 VDC		U.S. Mt'g. Holes	Std.	A	B	C	A	Welded	1		A	Button	-	-	-			
1	0.1 (0.05) amp 250 V	0.1 amp 125 VAC		U.S. Mt'g. Holes	Light	J	K	L	B	Short Solder	2		L	Lever SR	0.865	1.400	2.757			
2	3 (1) amp 250V	3 amp 125/250 VAC			Metric Mt'g. Holes	Std.	1	2	3	C	2.8 x 0.8 Q.C.	3		M	Lever HR	1.042	1.580	2.934		
3	6 (2) amp 250 V	5 amp 1/4 H.P. 125/250 VAC		Metric Mt'g. Holes		Light	7	8	9	E	Q.C. 6.3 x 0.8 Com Extended	4		Y	Alum. Lever SR	-	1.400	2.757		
4	10 (3) amp 250 V	10 amp 1/2 H.P. 125/250 VAC			Metric Mt'g. Holes	Std.	1	2	3	P	PCB	5		X	Alum. Lever HR	-	1.580	2.932		
5	16 (4) amp 250 V	15 amp 1/2 H.P. 125/250 VAC		Metric Mt'g. Holes		Light	7	8	9	Q	4.8 x 0.8 Q.C.	8		J	SS Lever	-	-	2.757		
7	3 (1) amp 250 V	3 amp 125/250 VAC 0.1 amp 125 VDC			Metric Mt'g. Holes	Std.	1	2	3	R	4.8 x 0.5 Q.C.	9		K	SS Lever	-	-	2.932		
8*	21 (8) amp 250 VAC	21 amp 250 VAC 1 H.P. 125 VAC 2 H.P. 250 VAC		Metric Mt'g. Holes		Light	7	8	9	S	Solder W. Temp. Stop	A		R	Roller SR	0.810	1.340	-		
9	-	10 amp 1/2 H.P. 125/250 VAC 6 amp 30 VDC			Metric Mt'g. Holes	Std.	1	2	3	V	6.3 x 0.8 Q.C.	B		T	Roller HR	0.987	1.516	-		
				Metric Mt'g. Holes		Light	7	8	9	Y	6.3 x 0.8 Q.C. spacing 5 mm			G	1-Way Roller SR	0.810	1.340	-		
					Metric Mt'g. Holes	Std.	1	2	3	Z	6.3 x 0.8 Q.C. spacing 7 mm			N	1-Way Roller HR	0.987	1.516	-		





*Only available with .250" terminals
VDE available on request (D42-D48)
VDE standard for D41

D4 Series

Miniature

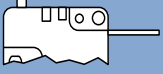
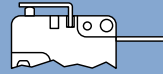
Light Force

Characteristics: OF – Operating Force, PT – Pretravel, OP – Operating Point, OT – Overtravel, MD – Movement Differential, AL – Actuator Length

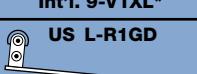
Switch Types	OF Max. gms.							PT Max. Inches mm	OP** Inches mm	OT Min. Inches mm	MD Max. Inches mm	AL Inches mm Tol. ±.031 in. Tol. (±.78 mm)
	D40	D41	D42	D43	D44	D45	D49					
 US L-R1AA Int'l. 9-V1AA*	15	15	15	45	75	100	75	0.047 1.19	0.558 0.598 14.17 15.19	0.050 1.27	0.010 0.250	—
 US L-R1LA Int'l. 9-V1LA*	15	15	15	45	75	100	75	0.062 1.57	0.580 0.620 14.73 15.75	0.050 1.27	0.016 0.406	0.865 21.97
 US L-R1YD Int'l. 9-V1YD*	8	8	8	22	37	50	37	0.125 3.18	0.555 0.645 14.10 16.38	0.085 2.16	0.030 0.760	1.400 35.56
 US L-R1XD Int'l. 9-V1XD*	5	5	5	14	22	30	22	0.220 5.59	0.525 0.675 13.34 17.15	0.130 3.30	0.040 1.02	1.580 40.13
 US L-R1RA Int'l. 9-V1RA*	15	15	15	45	75	100	75	0.047 1.19	0.776 0.836 19.71 21.23	0.040 1.02	0.010 0.250	0.810 20.57
 US L-R1RD Int'l. 9-V1RD*	8	8	8	22	37	50	37	0.125 3.18	0.761 0.851 19.33 21.62	0.085 2.16	0.030 0.760	1.340 34.04
 US L-R1TD Int'l. 9-V1TD*	5	5	5	14	22	30	22	0.200 5.08	0.731 0.881 18.57 22.38	0.120 3.05	0.040 1.02	1.516 38.51
 US L-R1YL Int'l. 9-V1YL*	3.5	3.5	3.5	10	17	22	17	0.300 7.62	0.500 0.700 12.70 17.78	0.187 4.75	0.065 1.65	2.757 70.03
 US L-R1XL Int'l. 9-V1XL*	2	2	2	6	10	13	10	0.500 12.70	0.425 0.775 10.80 19.69	0.312 7.92	0.100 2.54	2.932 74.47
 US L-R1GD Int'l. 9-V1GD*	8	8	8	22	37	50	37	0.125 3.18	1.000 1.090 25.40 27.69	0.085 2.16	0.030 0.760	1.340 34.04

Remarks: * These suffix numbers indicate SPDT contact arrangement. SPST-NO and SPST-NC also available. See ordering information on page 3-9.

** Measured above reference line. Refer to dimensional drawing on page 3-7.







D48: Operating force 120 Grams max., Pretravel 0.070 max., Operating Point .557 ±.020, Overtravel 0.040 min., Movement Differential 0.010 max.

D4 Series

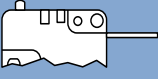
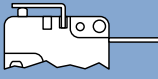
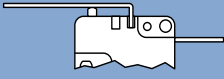
Miniature

Standard Force

Characteristics: OF – Operating Force, PT – Pretravel, OP – Operating Point, OT – Overtravel, MD – Movement Differential, AL – Actuator Length

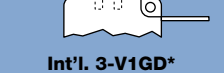
Switch Types	OF Max. gms.							PT Max. Inches mm	OP** Inches mm	OT Min. Inches mm	MD Max. Inches mm	AL Inches mm Tol. ±.031 in. Tol. (±.78 mm)
	D40	D41	D42	D43	D44	D45	D49					
 US C-R1AA Int'l. 3-V1AA*	75	75	75	170	285	400	285	0.047 1.19	0.558 0.598 14.17 15.19	0.050 1.27	0.010 0.250	—
 US C-R1LA Int'l. 3-V1LA*	75	75	75	170	285	400	285	0.062 1.57	0.580 0.620 14.73 15.75	0.050 1.27	0.016 0.406	0.865 21.97
 US C-R1LD Int'l. 3-V1LD*	35	35	35	86	144	200	144	0.125 3.18	0.555 0.645 14.10 16.38	0.085 2.16	0.030 0.760	1.400 35.56
 US C-R1MD Int'l. 3-V1MD*	20	20	20	51	86	120	86	0.220 5.59	0.525 0.675 13.34 17.15	0.130 3.30	0.040 1.02	1.580 40.13
 US C-R1JL Int'l. 3-V1JL*	17	17	17	38	63	90	63	0.300 7.62	0.500 0.700 12.70 17.78	0.187 4.75	0.065 1.65	2.757 70.03
 US C-R1RA Int'l. 3-V1RA*	75	75	75	170	285	400	285	0.047 1.19	0.776 0.836 19.71 21.23	0.040 1.02	0.010 0.250	0.810 20.57
 US C-R1RD Int'l. 3-V1RD*	35	35	35	86	144	200	144	0.125 3.18	0.761 0.851 19.33 21.62	0.085 2.16	0.030 0.760	1.340 34.04
 US C-R1TD Int'l. 3-V1TD*	25	25	25	51	86	120	86	0.200 5.08	0.731 0.881 18.57 22.38	0.120 3.05	0.040 1.02	1.516 38.51
 US C-R1GA Int'l. 3-V1GA*	75	75	75	170	285	400	285	0.047 1.19	1.015 1.075 25.78 27.31	0.040 1.02	0.010 0.250	.810 20.57
 US C-R1GD Int'l. 3-V1GD*	35	35	35	86	144	200	144	0.125 3.18	1.000 1.090 25.40 27.69	0.085 2.16	0.030 0.760	1.340 34.04

Remarks: * These suffix numbers indicate SPDT contact arrangement. SPST-NO and SPST-NC also available. See ordering information on page 3-9.

** Measured above reference line. Refer to dimensional drawing on page 3-7.