

FAST GATE TURN-OFF THYRISTORS

Thyristors in TO-220AB envelopes capable of being turned both on and off via the gate. They are suitable for use in high-frequency inverters, resonant power supplies, horizontal deflection systems etc. The devices have no reverse blocking capability. For reverse blocking operation use with a series diode, for reverse conducting operation use with an anti parallel diode.

QUICK REFERENCE DATA

			BT157-1300R		1500R	
			1300	1500	V	
Repetitive peak off-state voltage	V_{DRM}	max.				V
Non-repetitive peak on-state current	I_{TSM}	max.		20		A
Controllable anode current	I_{TCRM}	max.		12		A
Average on-state current	$I_T(AV)$	max.		3.2		A
Fall time	t_f	max.		200		ns

MECHANICAL DATA

Fig.1 TO-220AB

Dimensions in mm

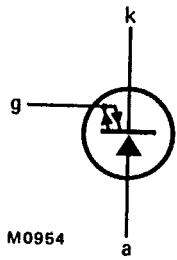

M0954

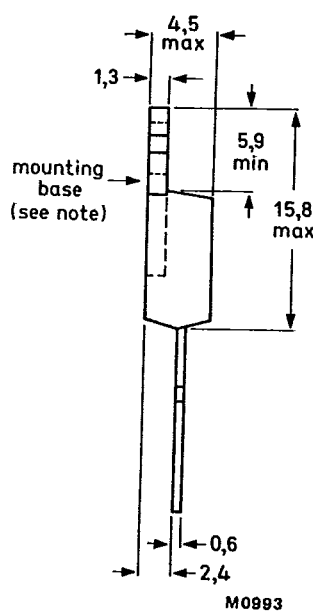
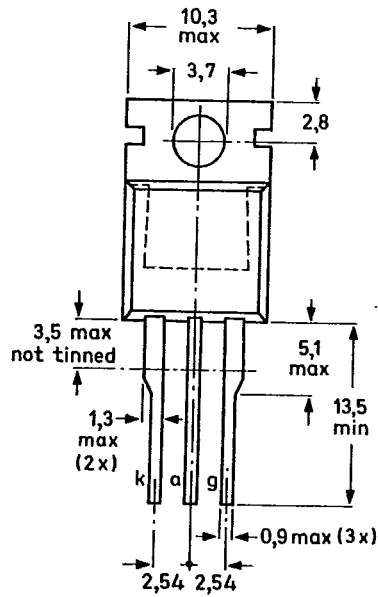

M0993

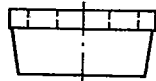

Net mass: 2 g

Note: The exposed metal mounting base is directly connected to the anode.

Accessories supplied on request: see data sheets Mounting instructions and accessories for TO-220 envelopes.

RATINGS

Limiting values in accordance with the Absolute Maximum System (IEC134)

Anode to cathode			BT157-1300R	1500R	
Transient off-state voltage	V_{DSM}	max.	1500	1650	V*
Repetitive peak off-state voltage	V_{DRM}	max.	1300	1500	V*
Working off-state voltage	V_{DW}	max.	1200	1300	V*
Continuous off-state voltage	V_D	max.	750	800	V*
Average on-state current (averaged over any 20 ms period) up to $T_{mb} = 80\text{ }^\circ\text{C}$					
	$I_T(AV)$	max.	3.2		A
Controllable anode current					
	I_{TCRM}	max.	12		A
Non-repetitive peak on-state current $t = 10\text{ ms}$; half-sinewave; $T_j = 120\text{ }^\circ\text{C}$ prior to surge					
	I_{TSM}	max.	20		A
$I^2 t$ for fusing; $t = 10\text{ ms}$					
	$I^2 t$	max.	2		$A^2 s$
Total power dissipation up to $T_{mb} = 25\text{ }^\circ\text{C}$					
	P_{tot}	max.	47.5		W
Gate to cathode					
Repetitive peak on-state current $T_j = 120\text{ }^\circ\text{C}$ prior to surge gate-cathode forward; $t = 1\text{ ms}$; half-sinewave					
	I_{GFM}	max.	25		A
gate-cathode reverse; $t = 20\text{ }\mu\text{s}$					
	I_{GRM}	max.	15		A
Average power dissipation (averaged over any 20 ms period)					
	$P_G(AV)$	max.	2.5		W
Temperatures					
Storage temperature					
	T_{stg}		-40 to +150		$^\circ\text{C}$
Operating junction temperature					
	T_j	max.	120		$^\circ\text{C}$
THERMAL RESISTANCE					
From junction to mounting base					
	$R_{th\ j-mb}$	=	2.0		K/W
From mounting base to heatsink with heatsink compound					
	$R_{th\ mb-h}$	=	0.3		K/W
with 56367 alumina insulator and heatsink compound (clip-mounted)					
	$R_{th\ mb-h}$	=	0.8		K/W
From junction to ambient in free air, mounted on a printed circuit board					
	$R_{th\ j-a}$	=	60		K/W

* Measured with gate-cathode connected together.

Fast gate turn-off thyristors

BT157 SERIES

T-25-13

CHARACTERISTICS

Anode to cathode

On-state voltage

$I_T = 2.5 \text{ A}; I_G = 0.2 \text{ A}; T_j = 120 \text{ }^\circ\text{C}$

$V_T < 3.4 \text{ V}^*$

Rate of rise of off-state voltage that will not trigger any off-state device; exponential method

$V_D = 2/3 V_{Dmax}; V_{GR} = 5 \text{ V}; T_j = 120 \text{ }^\circ\text{C}$

$dV_D/dt < 10 \text{ kV}/\mu\text{s}$

Rate of rise of off-state voltage that will not trigger any device following conduction; linear method;

$I_T = 1.8 \text{ A}; V_D = V_{DRMmax}; V_{GR} = 10 \text{ V}; T_j = 120 \text{ }^\circ\text{C}$

$dV_D/dt < 1.5 \text{ kV}/\mu\text{s}$

Off-state current

$V_D = V_{Dmax}; T_j = 120 \text{ }^\circ\text{C}$

$I_D < 2.0 \text{ mA}$

Latching current; $T_j = 25 \text{ }^\circ\text{C}$

$I_L \text{ typ. } 0.75 \text{ A}^{**}$

Gate to cathode

Voltage that will trigger all devices

$V_D = 12 \text{ V}; T_j = 25 \text{ }^\circ\text{C}$

$V_{GT} > 1.5 \text{ V}$

Current that will trigger all devices

$V_D = 12 \text{ V}; T_j = 25 \text{ }^\circ\text{C}$

$I_{GT} > 200 \text{ mA}$

Minimum reverse breakdown voltage

$I_{GRM} = 1.0 \text{ mA}$

$V_{(BR)GR} > 10 \text{ V}$

Switching characteristics (resistive load)

Turn-on when switched to $I_T = 2.5 \text{ A}$ from $V_D = 250 \text{ V}$

with $I_{GF} = 0.4 \text{ A}; T_j = 25 \text{ }^\circ\text{C}$

delay time

rise time

$t_d < 0.25 \mu\text{s}$
 $t_r < 1.0 \mu\text{s}$

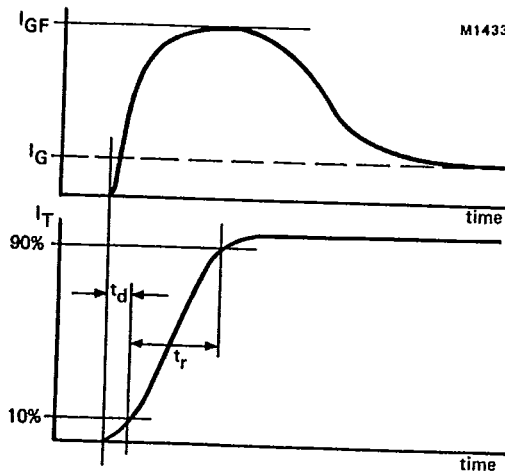

Fig.2 Waveforms

* Measured under pulse conditions to avoid excessive dissipation.

** Below latching level the device behaves like a transistor with a gain dependent on current.

Switching characteristics (inductive load)

Turn-off when switched from $I_T = 2.5 \text{ A}$ to $V_D = V_{DRM} \text{ max}$
 $V_{GR} = 10 \text{ V}$; $L_G \leq 1.5 \mu\text{H}$; $L_S \leq 0.25 \mu\text{H}$, $T_j = 25 \text{ }^\circ\text{C}$

storage time

$t_s < 0.5 \mu\text{s}$

fall time

$t_f < 0.20 \mu\text{s}$

peak reverse gate current

$I_{GR} < 2.8 \text{ A}$

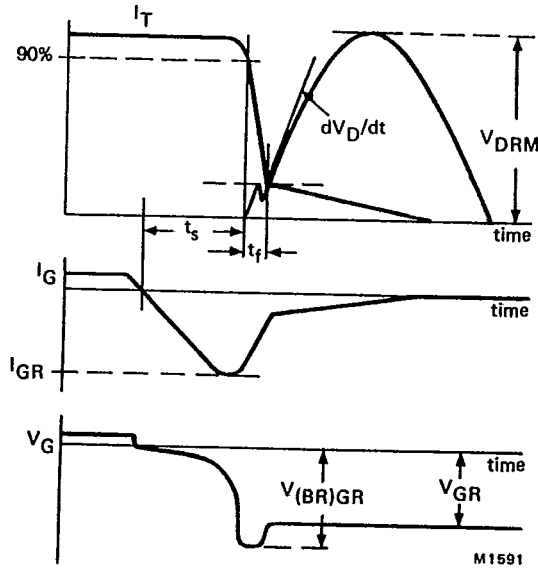

Fig.3 Waveforms

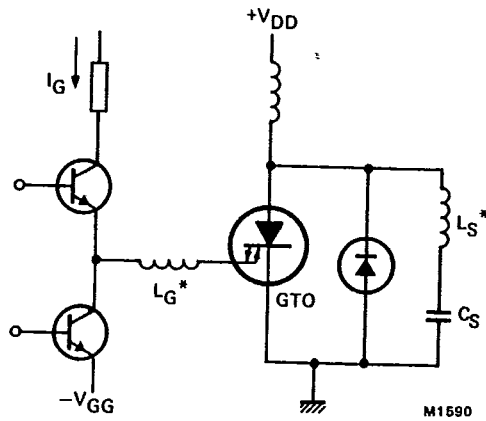

Fig.4 Inductive load test circuit

* Indicates stray series inductance only.

Fast gate turn-off thyristors

BT157 SERIES

T-25-13

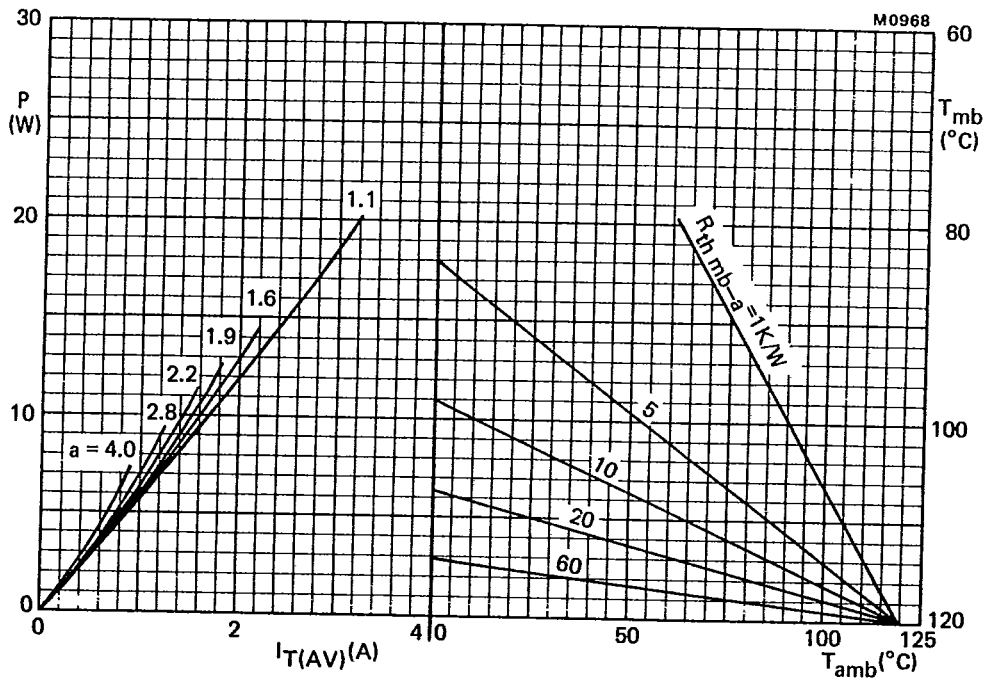

Fig.5 The right-hand part shows the interrelationship between the power (derived from the left-hand part) and the maximum permissible temperatures.

$$a = \text{form factor} = \frac{I_T(\text{RMS})}{I_T(\text{AV})}$$

P = Power excluding switching losses

T-25-13

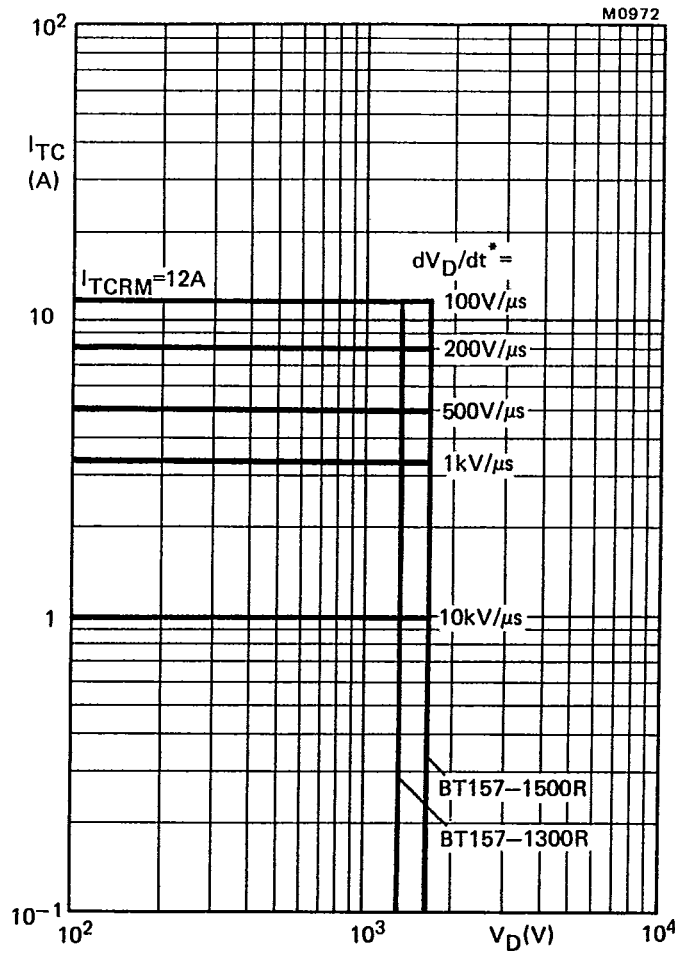

Fig.6 Anode current which can be turned off versus anode voltage;
inductive load, $V_{GR} = 10$ V; $L_G \leq 1.5 \mu H$; $L_S \leq 0.25 \mu H$; $T_j = 85$ °C
* dV_D/dt is calculated from I_T/C_S .

T-25-13

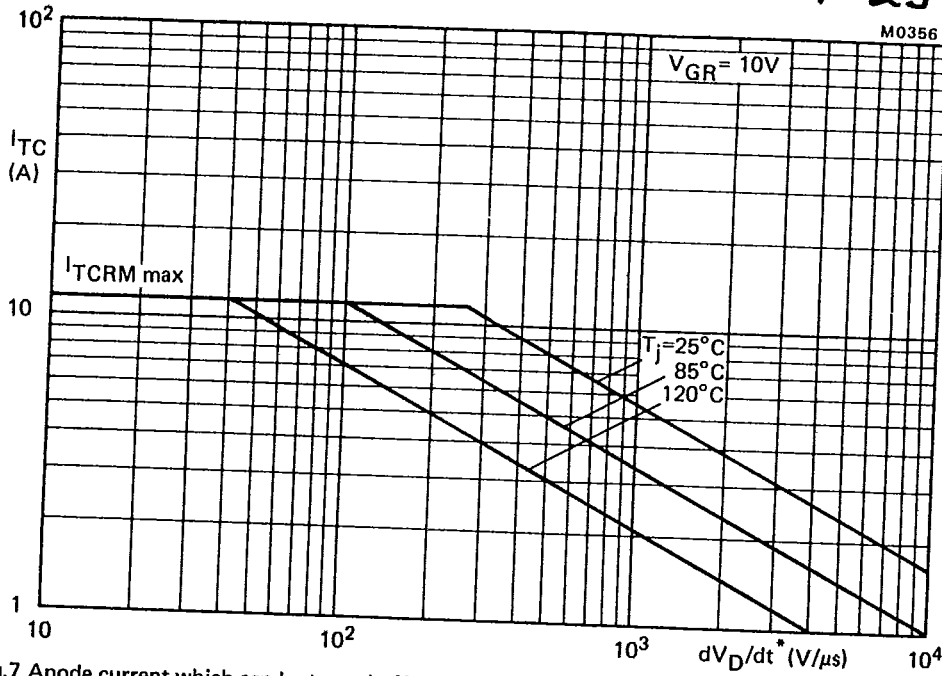

Fig.7 Anode current which can be turned off versus applied dV_D/dt^* ; inductive load; $V_{GR} = 10 V$; $L_G \leq 1.5 \mu H$; $L_S \leq 0.25 \mu H$; $*dV_D/dt$ is calculated from I_T/C_S .

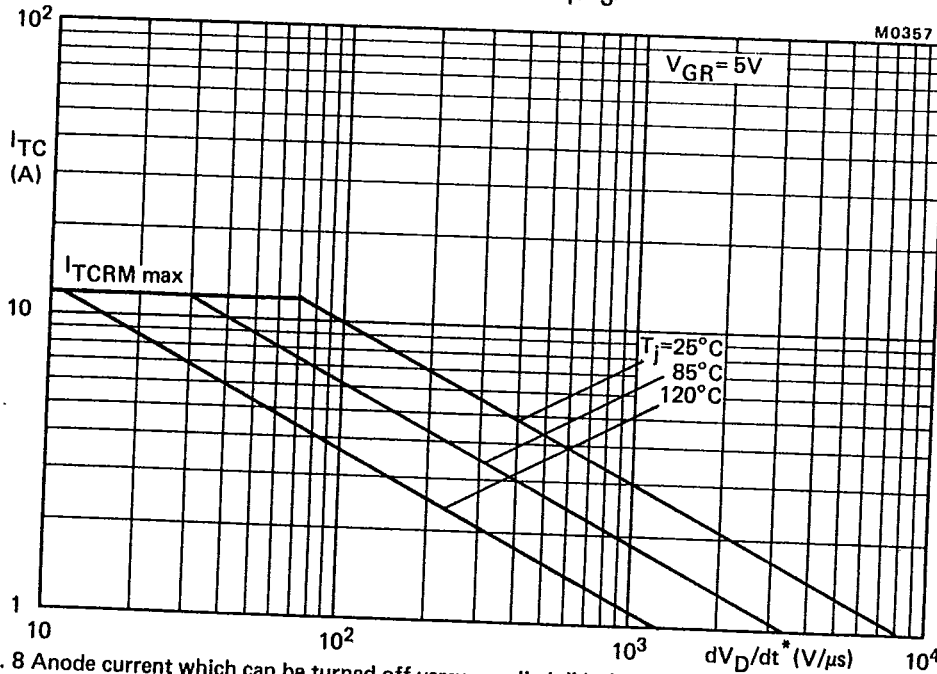

Fig. 8 Anode current which can be turned off versus applied dV_D/dt ; inductive load; $V_{GR} = 5 V$. $L_G \leq 1.5 \mu H$; $L_S \leq 0.25 \mu H$; $*dV_D/dt$ is calculated from I_T/C_S .

T-25-13

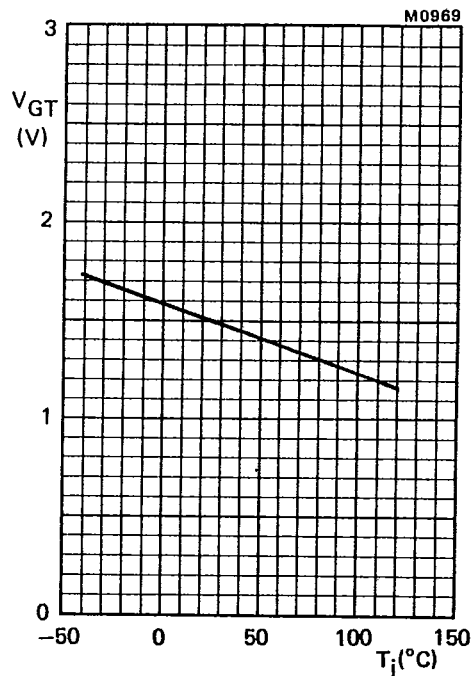

Fig.9 Minimum gate voltage that will trigger all devices as a function of junction temperature; $V_D = 12$ V.

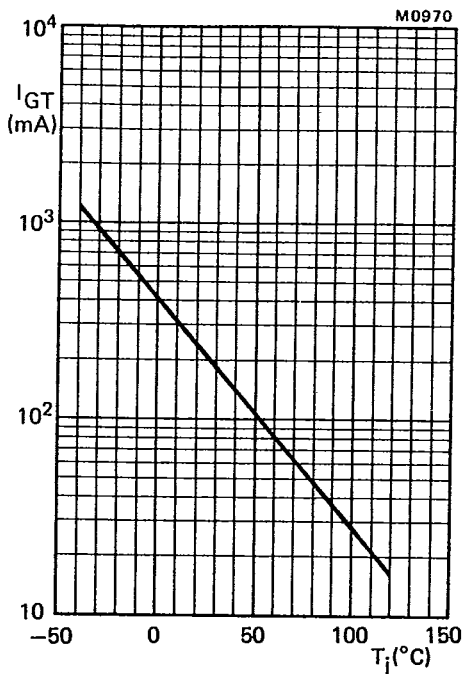

Fig.10 Minimum gate current that will trigger all devices as a function of junction temperature; $V_D = 12$ V.

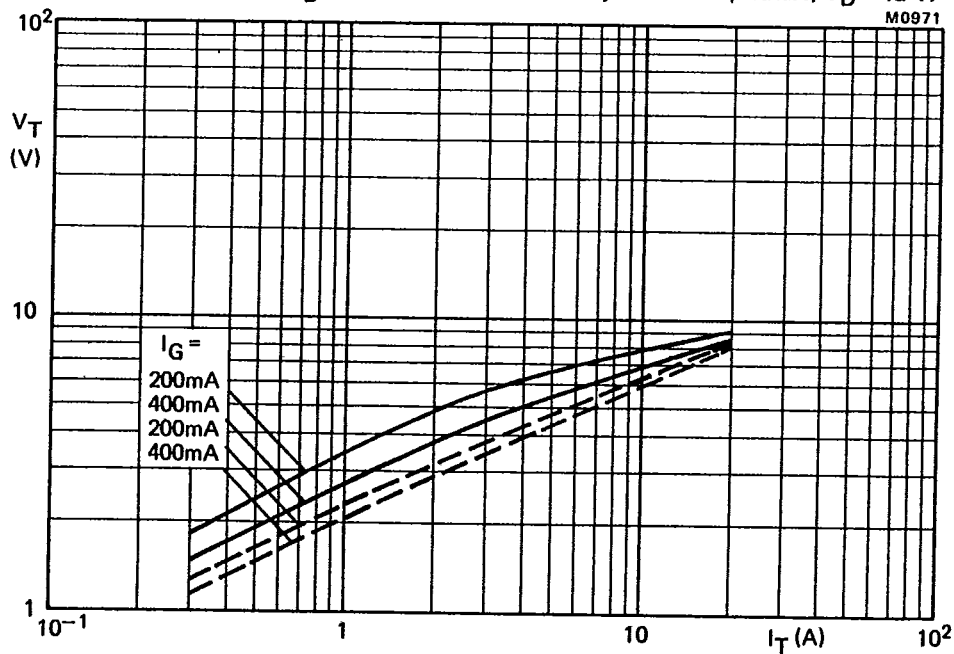

Fig.11 Maximum V_T versus I_T ; — $T_j = 25$ $^{\circ}C$; - - - $T_j = 120$ $^{\circ}C$.

T-25-13

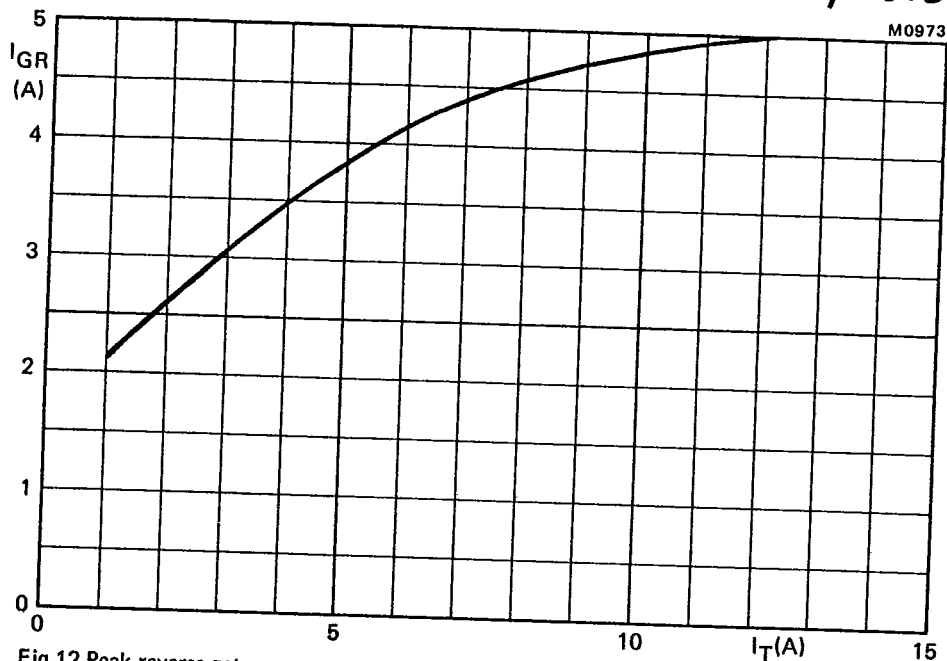

Fig.12 Peak reverse gate current versus anode current at turn-off; inductive load; $V_{GR} = 10$ V; $I_G = 0.2$ A; $L_G = 0.8 \mu\text{H}$; $T_j = 120$ °C; maximum values.

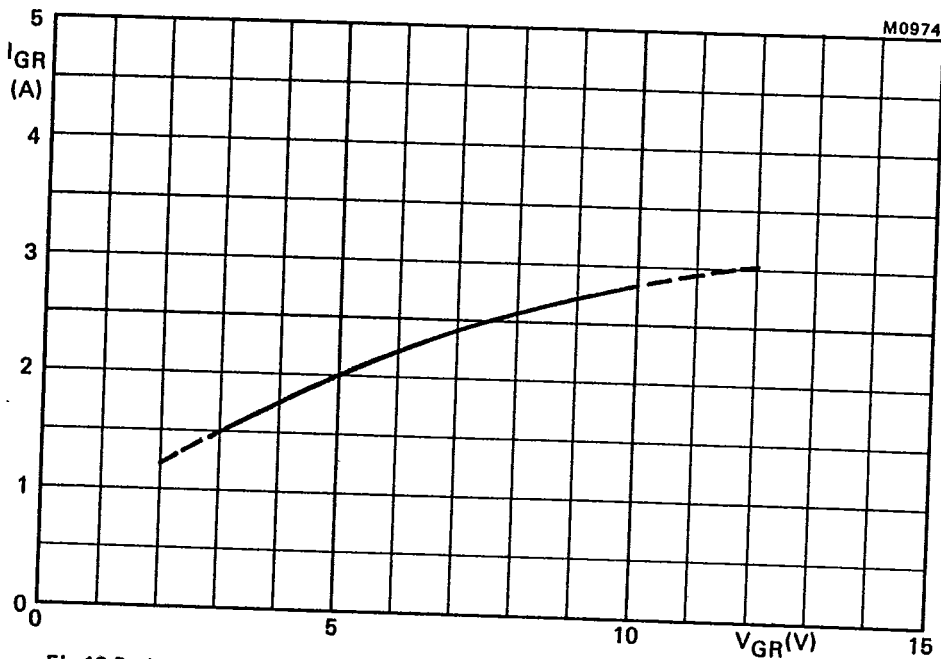

Fig.13 Peak reverse gate current versus applied gate voltage; inductive load; $I_T = 2.5$ A; $I_G = 0.2$ A; $L_G = 0.8 \mu\text{H}$; $T_j = 120$ °C; maximum values.

T-25-13

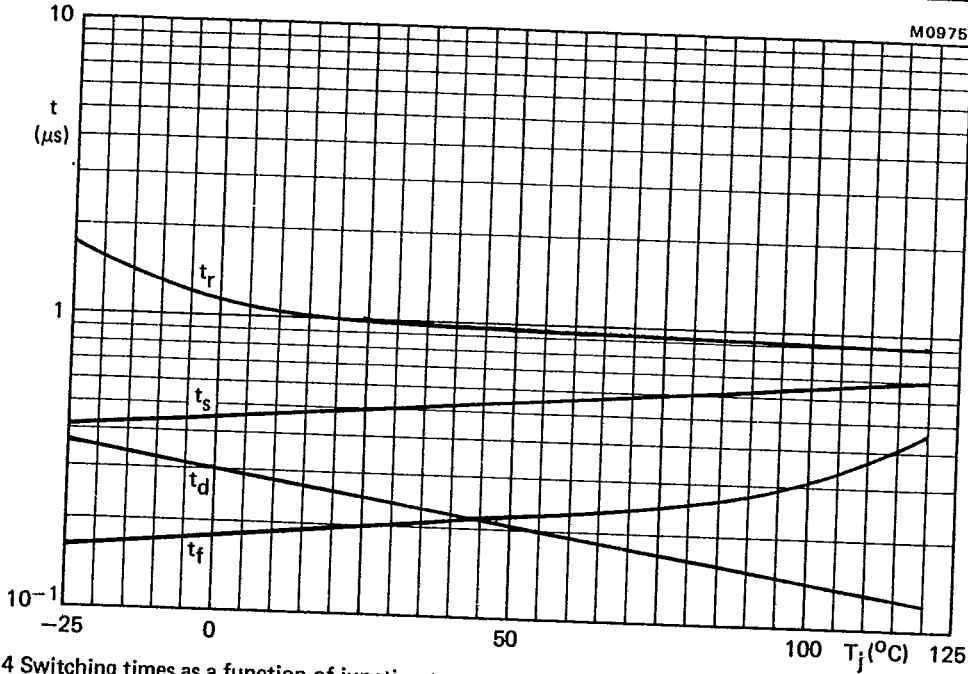

Fig.14 Switching times as a function of junction temperature; $V_D \geq 250 V$; $I_T = 2.5 A$; $I_{GF} = 0.4 A$; $I_G = 0.2 A$; $V_{GR} = 10 V$; $L_G = 0.8 \mu H$; maximum values.

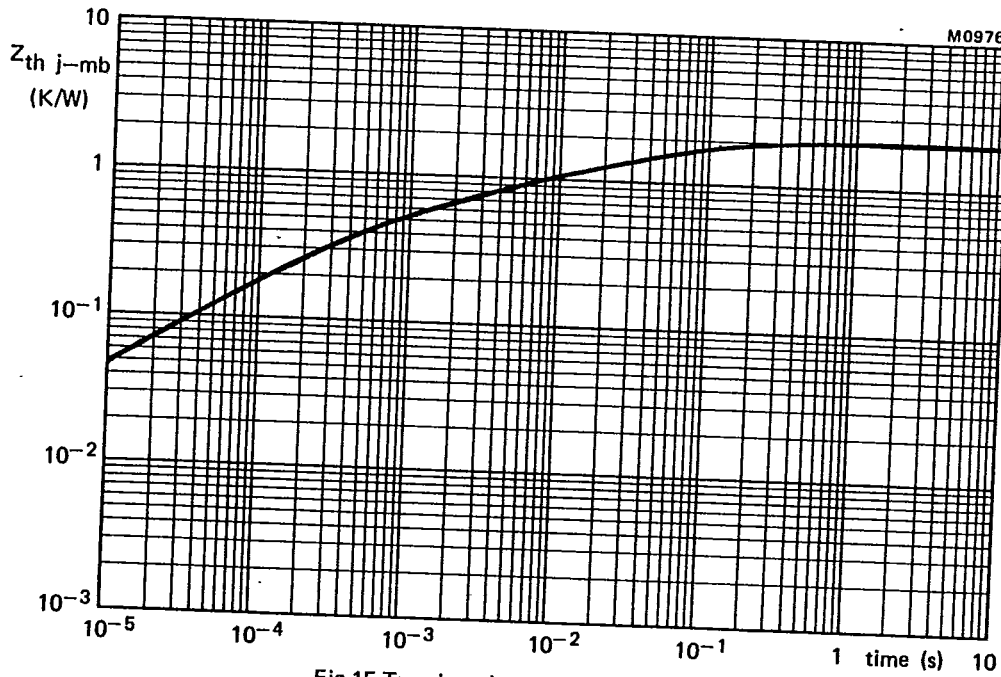

Fig.15 Transient thermal impedance.

T-25-13

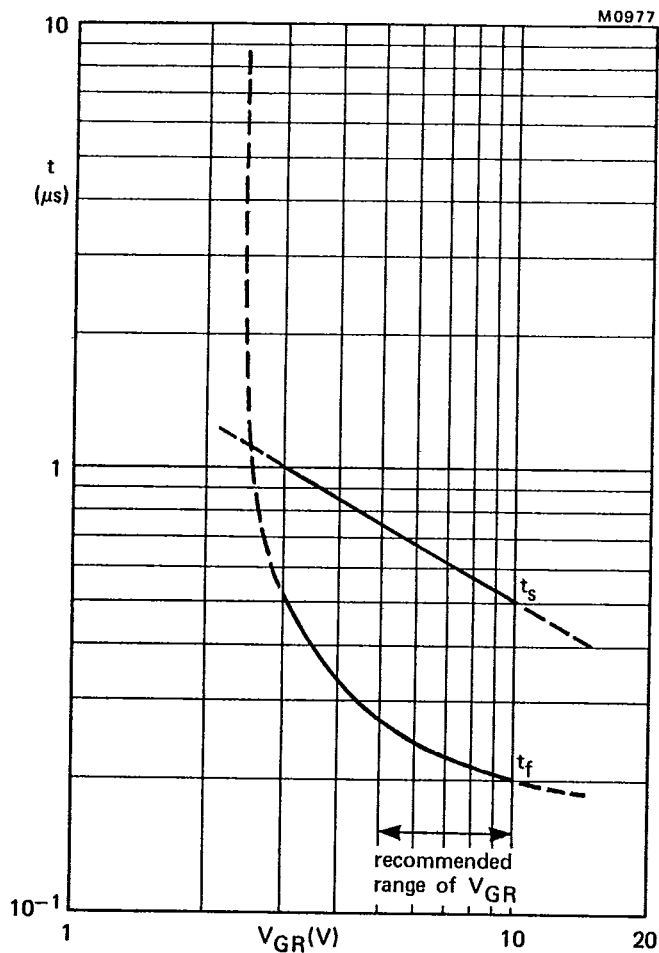

Fig.16 Storage and fall times versus applied reverse gate voltage; inductive load; $I_T = 2.5$ A; $L_G = 0.8$ μ H; $I_G = 0.2$ A; $T_j = 25$ °C; maximum values.

T-25-13

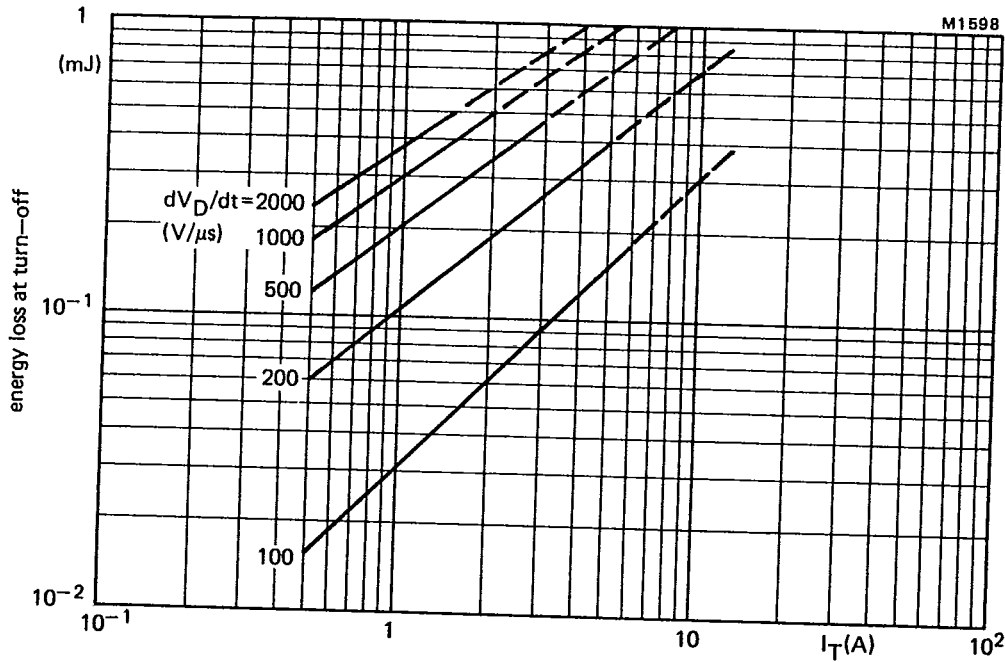

Fig.17 Maximum energy loss at turn-off (per cycle) as a function of anode current and applied dV_D/dt (calculated from I_T/C_S); reappplied voltage sinusoidal up to $V_{DRM} = 1200$ V; $V_{GR} = 10$ V; $I_G = 0.2$ A; $L_G \leq 1.5 \mu H$; $L_S \leq 0.25 \mu H$; $T_j = 120$ °C.

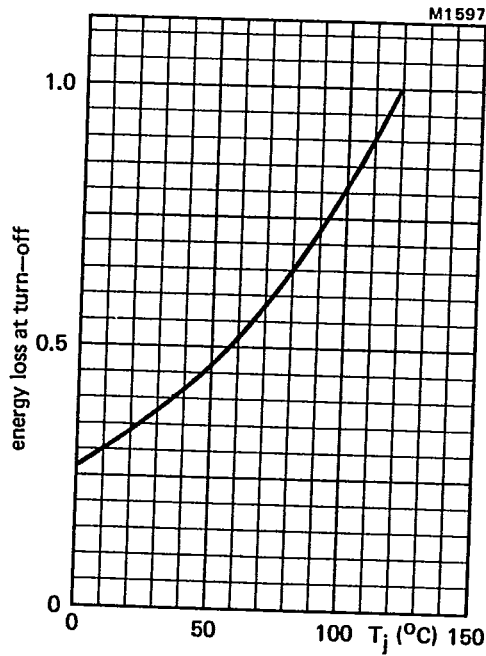

Fig.18 Energy loss at turn off as a function of junction temperature; $I_G = 0.2$ A; $V_{GR} = 10$ V. Normalised to $T_j = 120$ °C.