

2SJ245 (L), 2SJ245 (S)

SILICON P-CHANNEL MOS FET

Application

High speed power switching

Features

- Low on-resistance
- High speed switching
- Low drive current
- 4 V Gate drive device can be driven from 5 V source
- Suitable for Switching regulator, DC – DC converter

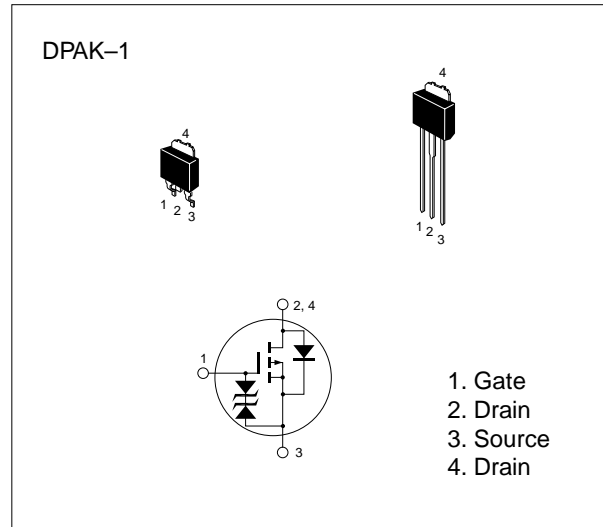

Table 1 Absolute Maximum Ratings ($T_a = 25^\circ\text{C}$)

Item	Symbol	Ratings	Unit
Drain to source voltage	V_{DSS}	-60	V
Gate to source voltage	V_{GSS}	± 20	V
Drain current	I_D	-5	A
Drain peak current	$I_{D(\text{pulse})}^*$	-20	A
Body-drain diode reverse drain current	I_{DR}	-5	A
Channel dissipation	P_{ch}^{**}	20	W
Channel temperature	T_{ch}	150	$^\circ\text{C}$
Storage temperature	T_{stg}	-55 to +150	$^\circ\text{C}$

* $PW \leq 10 \mu\text{s}$, duty cycle $\leq 1\%$

** Value at $T_c = 25^\circ\text{C}$

Table 2 Electrical Characteristics (Ta = 25°C)

Item	Symbol	Min	Typ	Max	Unit	Test conditions
Drain to source breakdown voltage	$V_{(BR)DSS}$	-60	—	—	V	$I_D = -10 \text{ mA}$, $V_{GS} = 0$
Gate to source breakdown voltage	$V_{(BR)GSS}$	± 20	—	—	V	$I_G = \pm 100 \text{ }\mu\text{A}$, $V_{DS} = 0$
Gate to source leak current	I_{GSS}	—	—	± 10	μA	$V_{GS} = \pm 16 \text{ V}$, $V_{DS} = 0$
Zero gate voltage drain current	I_{DSS}	—	—	-100	μA	$V_{DS} = -50 \text{ V}$, $V_{GS} = 0$
Gate to source cutoff voltage	$V_{GS(off)}$	-1.0	—	-2.0	V	$I_D = -1 \text{ mA}$, $V_{DS} = -10 \text{ V}$
Static drain to source on state resistance	$R_{DS(on)}$	—	0.2	0.25	Ω	$I_D = -3 \text{ A}$ $V_{GS} = -10 \text{ V}^*$
		—	0.28	0.38	Ω	$I_D = -3 \text{ A}$ $V_{GS} = -4 \text{ V}^*$
Forward transfer admittance	$ y_{fs} $	2.2	3.7	—	S	$I_D = -3 \text{ A}$ $V_{DS} = -10 \text{ V}^*$
Input capacitance	C_{iss}	—	610	—	pF	$V_{DS} = -10 \text{ V}$
Output capacitance	C_{oss}	—	315	—	pF	$V_{GS} = 0$
Reverse transfer capacitance	C_{rss}	—	95	—	pF	$f = 1 \text{ MHz}$
Turn-on delay time	$t_{d(on)}$	—	12	—	ns	$I_D = -3 \text{ A}$
Rise time	t_r	—	45	—	ns	$V_{GS} = -10 \text{ V}$
Turn-off delay time	$t_{d(off)}$	—	170	—	ns	$R_L = 10 \text{ }\Omega$
Fall time	t_f	—	90	—	ns	
Body-drain diode forward voltage	V_{DF}	—	-1.1	—	V	$I_F = -5 \text{ A}$, $V_{GS} = 0$
Body-drain diode reverse recovery time	t_{rr}	—	160	—	ns	$I_F = -5 \text{ A}$, $V_{GS} = 0$, $di_F / dt = 50 \text{ A} / \mu\text{s}$

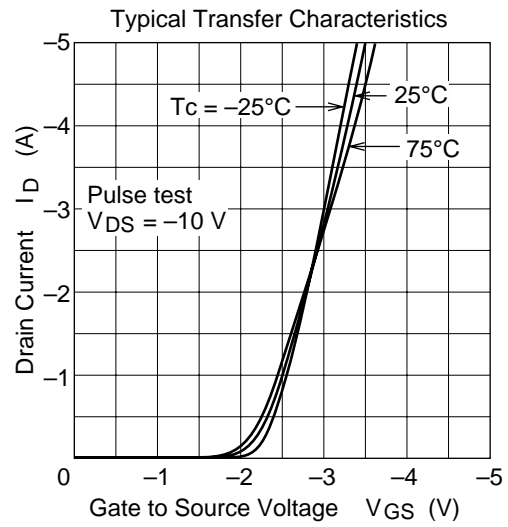
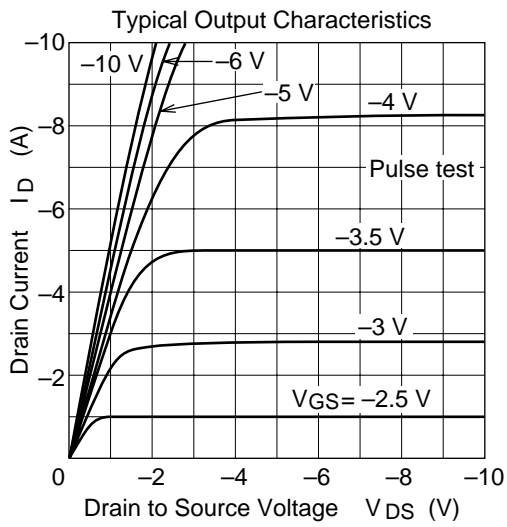
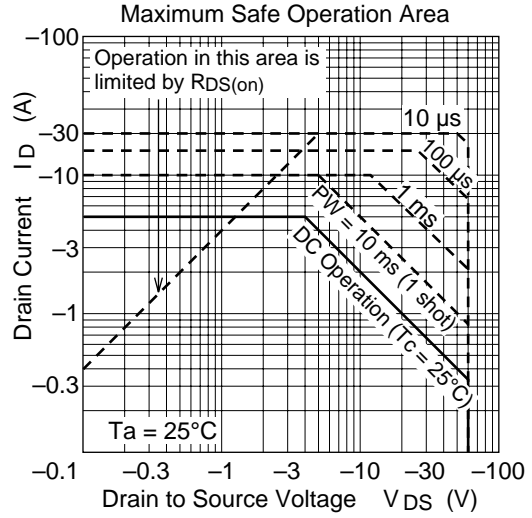
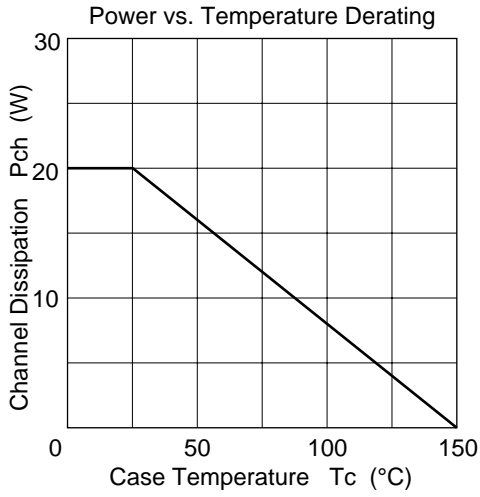

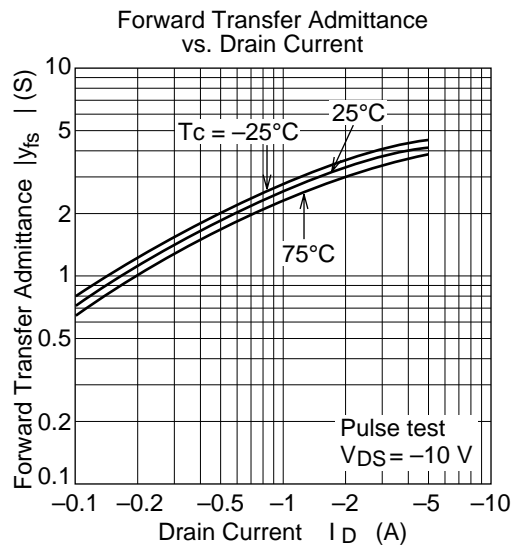
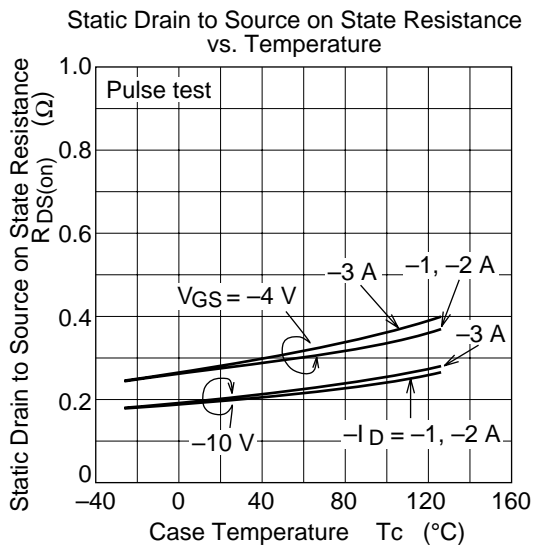
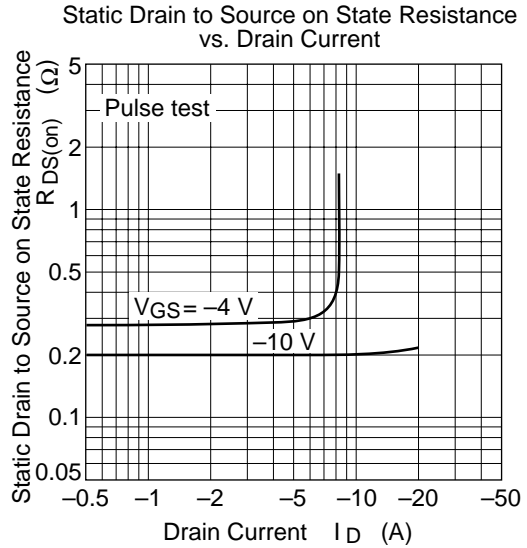
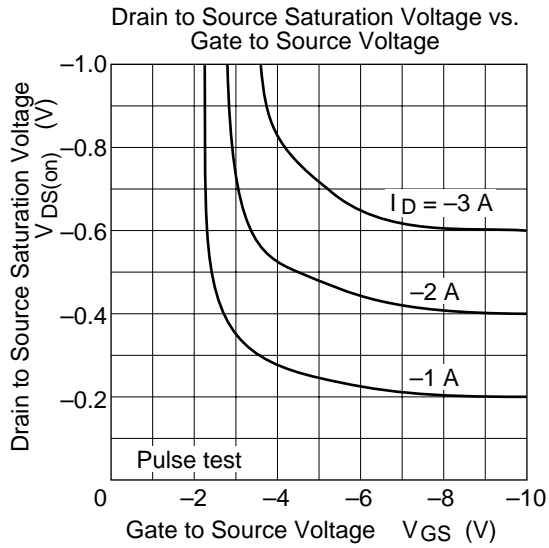

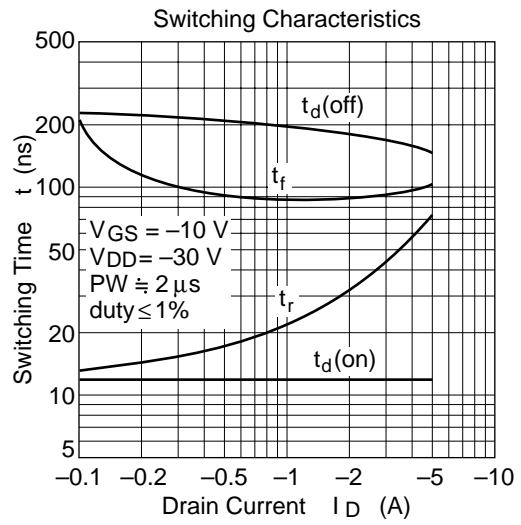
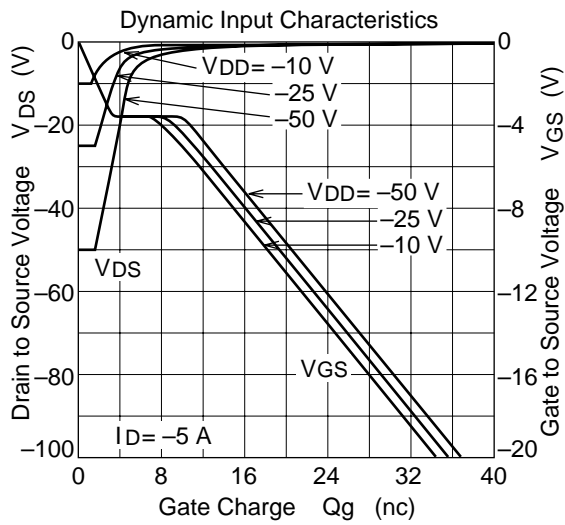
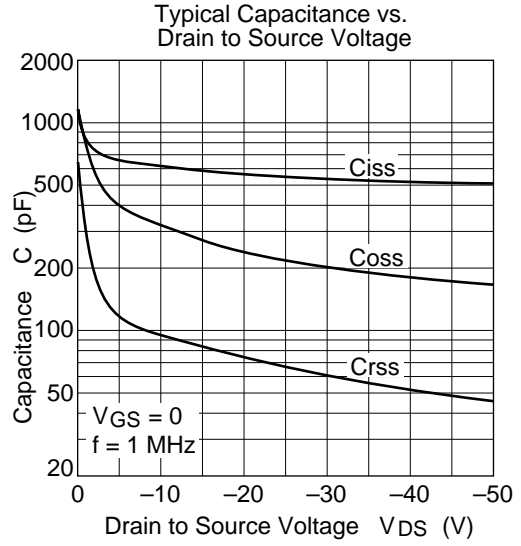
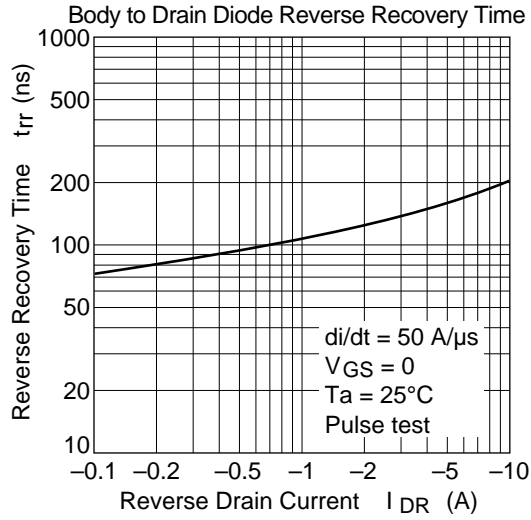

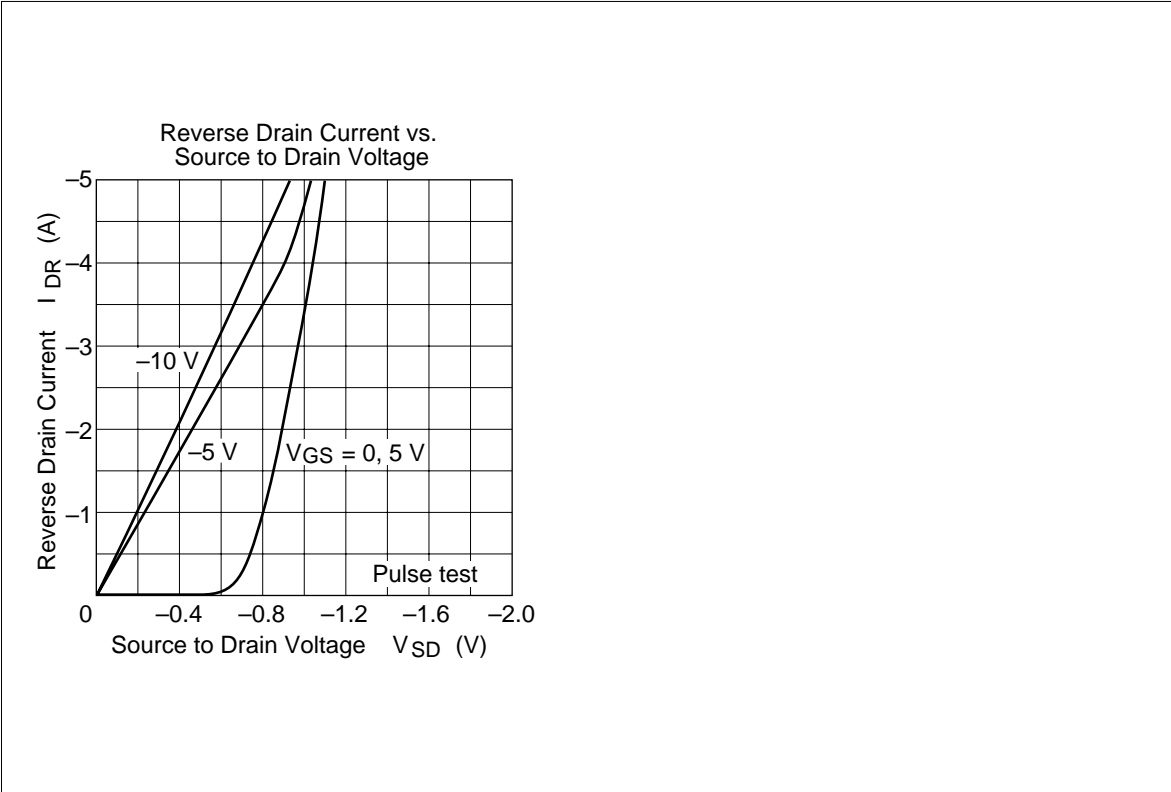

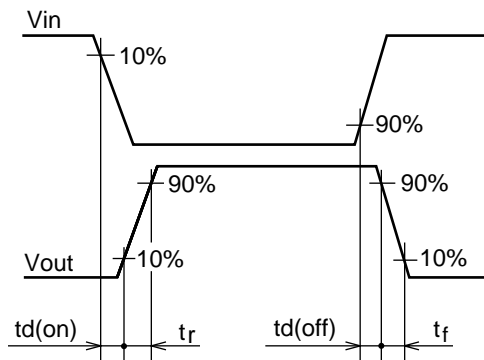
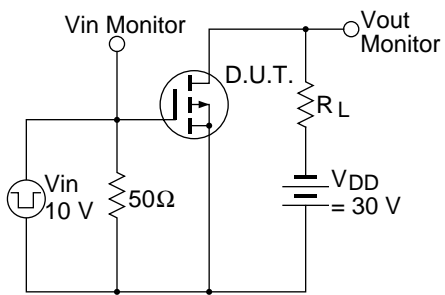
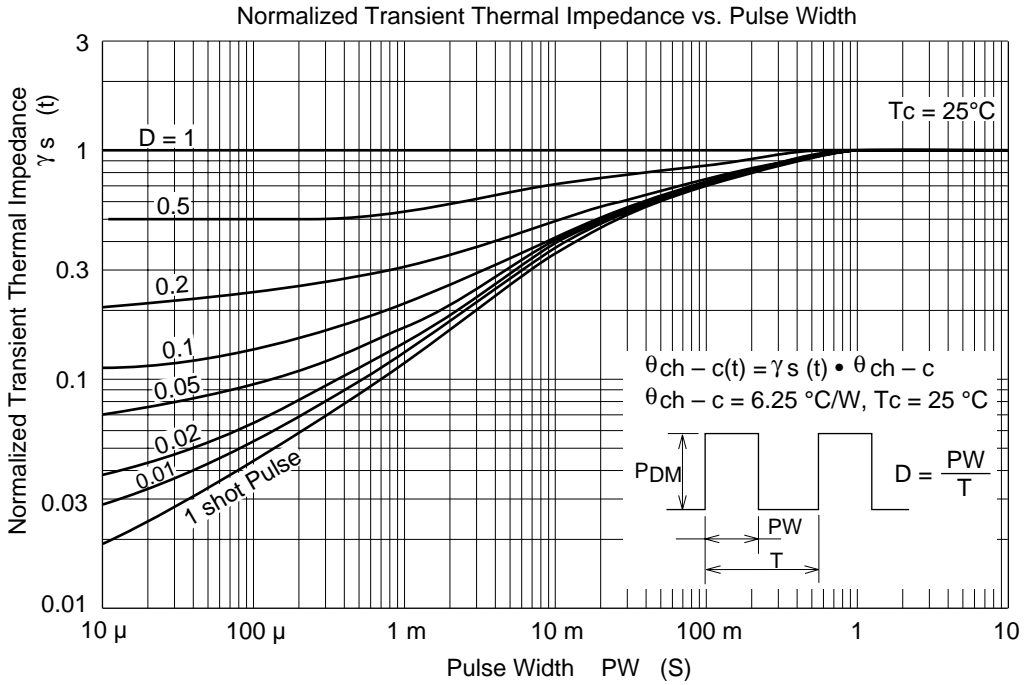

This datasheet has been downloaded from:

www.DatasheetCatalog.com

Datasheets for electronic components.