



## N-Channel 100-V (D-S) 175°C MOSFET

PRODUCT SUMMARY		
$V_{(BR)DSS}$ (V)	$r_{DS(on)}$ ( $\Omega$ )	$I_D$ (A)
100	0.016 @ $V_{GS} = 10$ V	60
	0.018 @ $V_{GS} = 4.5$ V	56

### FEATURES

- TrenchFET® Power MOSFET
- 175°C Junction Temperature
- PWM Optimized

### APPLICATIONS

- DC/DC Primary Side Switch

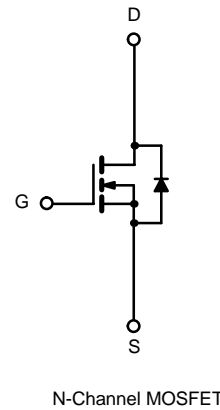
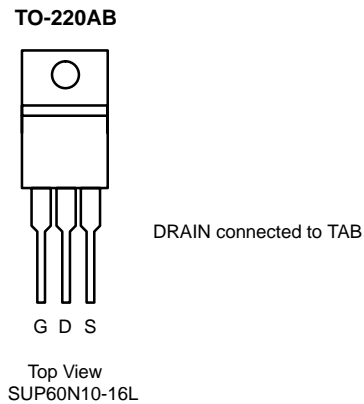

ABSOLUTE MAXIMUM RATINGS ( $T_C = 25^\circ\text{C}$ UNLESS OTHERWISE NOTED)			
Parameter	Symbol	Limit	Unit
Drain-Source Voltage	$V_{DS}$	100	V
Gate-Source Voltage	$V_{GS}$	$\pm 20$	
Continuous Drain Current ( $T_J = 175^\circ\text{C}$ )	$I_D$	$T_C = 25^\circ\text{C}$	60
		$T_C = 125^\circ\text{C}$	35
Pulsed Drain Current	$I_{DM}$	100	A
Avalanche Current	$I_{AR}$	40	
Repetitive Avalanche Energy <sup>a</sup>	$E_{AR}$	80	mJ
Maximum Power Dissipation <sup>a</sup>	$P_D$	150 <sup>b</sup>	W
Operating Junction and Storage Temperature Range	$T_J, T_{stg}$	-55 to 175	$^\circ\text{C}$

THERMAL RESISTANCE RATINGS			
Parameter	Symbol	Limit	Unit
Junction-to-Ambient (Free Air)	$R_{thJA}$	62.5	$^\circ\text{C/W}$
Junction-to-Case	$R_{thJC}$	1.0	

Notes

- Duty cycle  $\leq 1\%$ .
- See SOA curve for voltage derating.
- When mounted on 1" square PCB (FR-4 material).



SPECIFICATIONS (T <sub>J</sub> = 25 °C UNLESS OTHERWISE NOTED)						
Parameter	Symbol	Test Condition	Min	Typ	Max	Unit
<b>Static</b>						
Drain-Source Breakdown Voltage	V <sub>(BR)DSS</sub>	V <sub>GS</sub> = 0 V, I <sub>D</sub> = 250 μA	100			V
Gate-Threshold Voltage	V <sub>GS(th)</sub>	V <sub>DS</sub> = V <sub>GS</sub> , I <sub>D</sub> = 250 μA	1		3	
Gate-Body Leakage	I <sub>GSS</sub>	V <sub>DS</sub> = 0 V, V <sub>GS</sub> = ±20 V			±100	nA
Zero Gate Voltage Drain Current	I <sub>DSS</sub>	V <sub>DS</sub> = 80 V, V <sub>GS</sub> = 0 V			1	μA
		V <sub>DS</sub> = 80 V, V <sub>GS</sub> = 0 V, T <sub>J</sub> = 125 °C			50	
		V <sub>DS</sub> = 80 V, V <sub>GS</sub> = 0 V, T <sub>J</sub> = 175 °C			250	
On-State Drain Current <sup>a</sup>	I <sub>D(on)</sub>	V <sub>DS</sub> ≥ 5 V, V <sub>GS</sub> = 10 V	100			A
Drain-Source On-State Resistance <sup>a</sup>	r <sub>DS(on)</sub>	V <sub>GS</sub> = 10 V, I <sub>D</sub> = 30 A		0.0125	0.016	Ω
		V <sub>GS</sub> = 4.5 V, I <sub>D</sub> = 20 A		0.014	0.018	
		V <sub>GS</sub> = 10 V, I <sub>D</sub> = 30 A, T <sub>J</sub> = 125 °C			0.030	
		V <sub>GS</sub> = 10 V, I <sub>D</sub> = 30 A, T <sub>J</sub> = 175 °C			0.040	
Forward Transconductance <sup>a</sup>	g <sub>fs</sub>	V <sub>DS</sub> = 15 V, I <sub>D</sub> = 30 A	25			S
<b>Dynamic<sup>b</sup></b>						
Input Capacitance	C <sub>iss</sub>	V <sub>GS</sub> = 0 V, V <sub>DS</sub> = 25 V, f = 1 MHz		3820		pF
Output Capacitance	C <sub>oss</sub>			450		
Reverse Transfer Capacitance	C <sub>rss</sub>			210		
Total Gate Charge <sup>c</sup>	Q <sub>g</sub>	V <sub>DS</sub> = 50 V, V <sub>GS</sub> = 10 V, I <sub>D</sub> = 60 A		73	110	nC
Gate-Source Charge <sup>c</sup>	Q <sub>gs</sub>			15		
Gate-Drain Charge <sup>c</sup>	Q <sub>gd</sub>			20		
Gate Resistance	R <sub>G</sub>			1.5		Ω
Turn-On Delay Time <sup>c</sup>	t <sub>d(on)</sub>	V <sub>DD</sub> = 50 V, R <sub>L</sub> = 0.83 Ω I <sub>D</sub> ≅ 60 A, V <sub>GEN</sub> = 10 V, R <sub>G</sub> = 2.5 Ω		12	25	ns
Rise Time <sup>c</sup>	t <sub>r</sub>			90	135	
Turn-Off Delay Time <sup>c</sup>	t <sub>d(off)</sub>			55	85	
Fall Time <sup>c</sup>	t <sub>f</sub>			130	195	
<b>Source-Drain Diode Ratings and Characteristics (T<sub>C</sub> = 25 °C)<sup>b</sup></b>						
Continuous Current	I <sub>S</sub>				60	A
Pulsed Current	I <sub>SM</sub>				100	
Forward Voltage <sup>a</sup>	V <sub>SD</sub>	I <sub>F</sub> = 60 A, V <sub>GS</sub> = 0 V		1.0	1.5	V
Reverse Recovery Time	t <sub>rr</sub>	I <sub>F</sub> = 50 A, di/dt = 100 A/μs		62	100	ns
Peak Reverse Recovery Current	I <sub>RM(REC)</sub>			3.1	5	A
Reverse Recovery Charge	Q <sub>rr</sub>			0.10	0.25	μC

Notes

- a. Pulse test; pulse width ≤ 300 μs, duty cycle ≤ 2%.
- b. Guaranteed by design, not subject to production testing.
- c. Independent of operating temperature.



**TYPICAL CHARACTERISTICS (25°C UNLESS NOTED)**

**Output Characteristics**

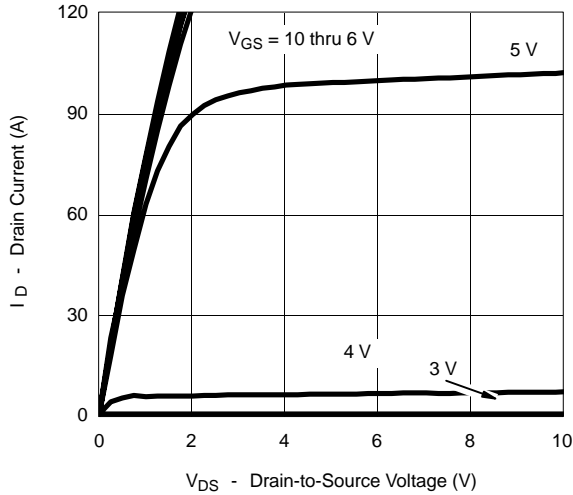

**Transfer Characteristics**

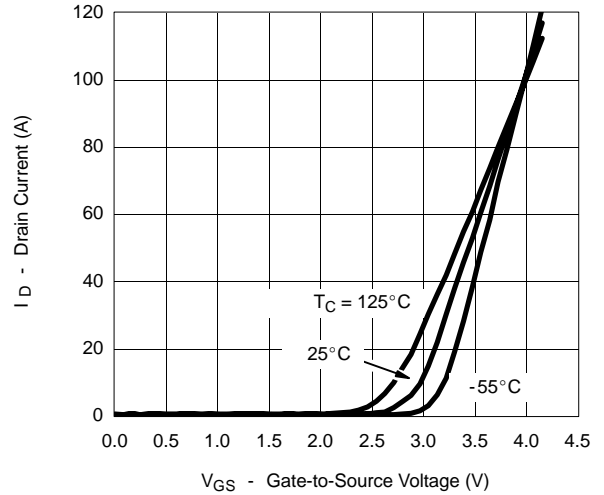

**Transconductance**

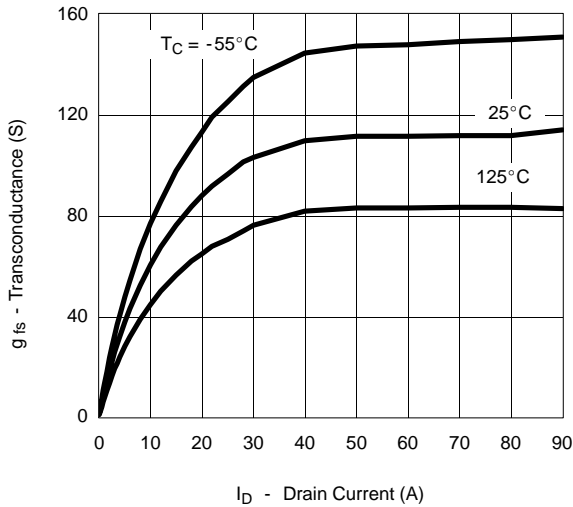

**On-Resistance vs. Drain Current**

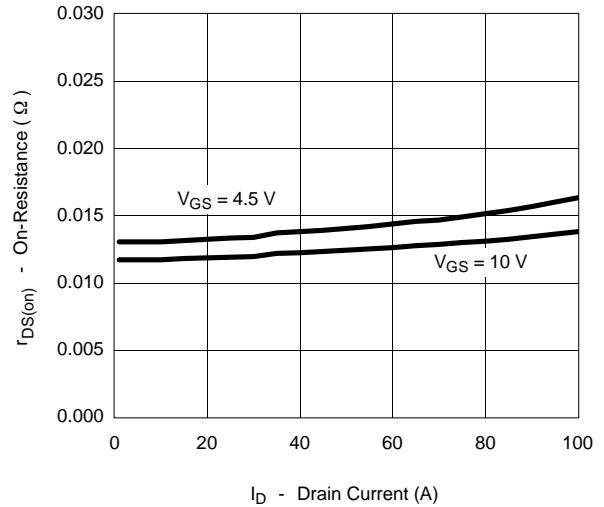

**Capacitance**

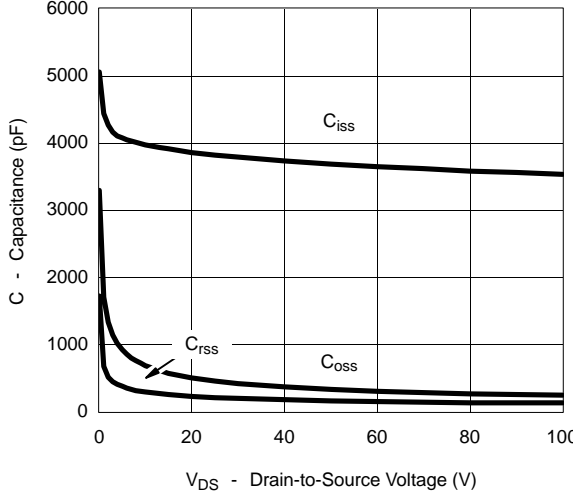

**Gate Charge**

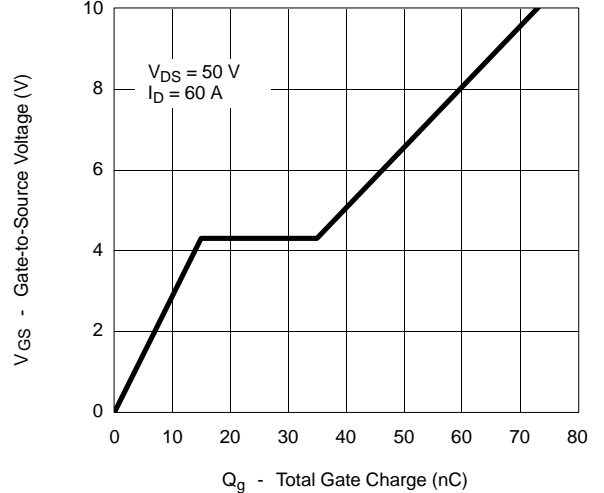

**TYPICAL CHARACTERISTICS (25 °C UNLESS NOTED)**

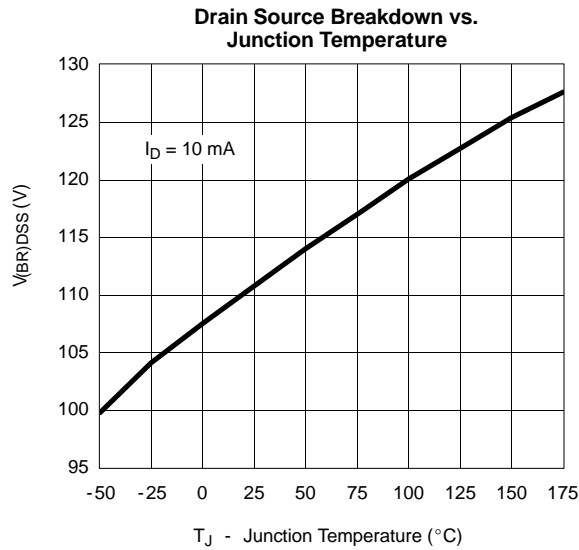
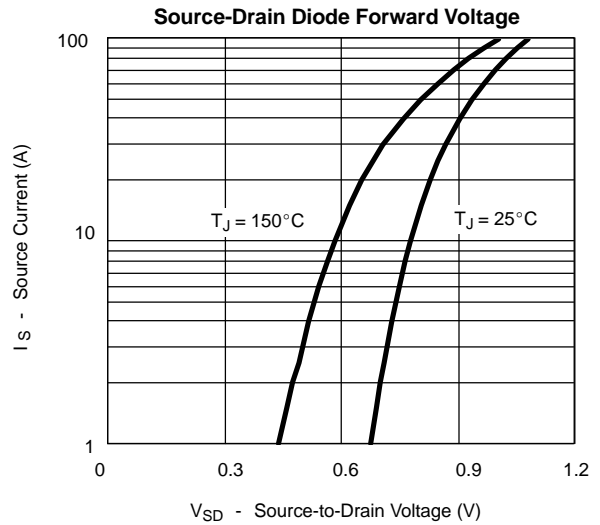
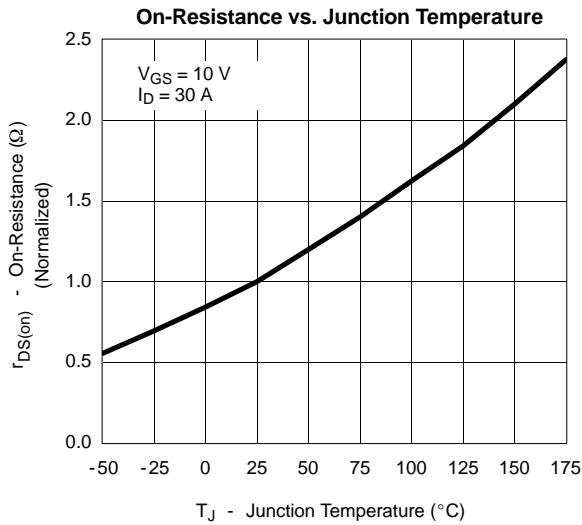



**THERMAL RATINGS**

Maximum Avalanche and Drain Current vs. Case Temperature

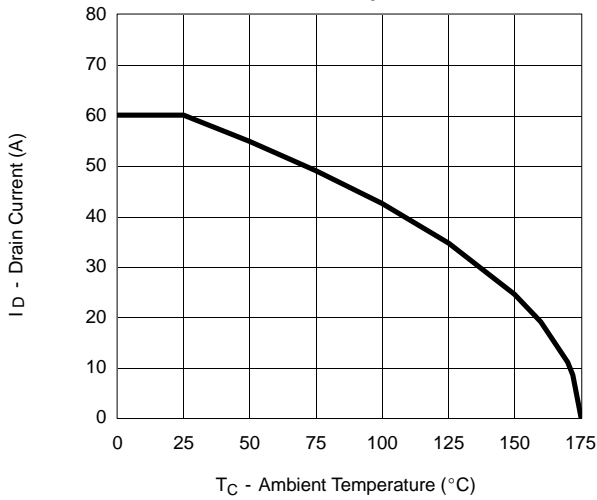

Safe Operating Area

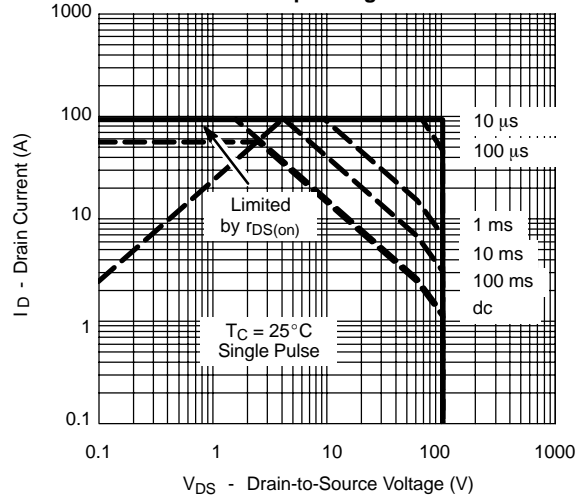

Normalized Thermal Transient Impedance, Junction-to-Case

